











**TECHNICON**  
INSTRUMENTS

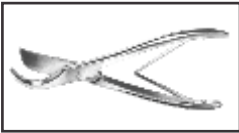
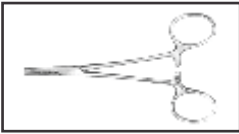

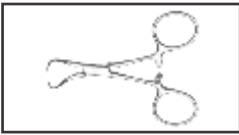
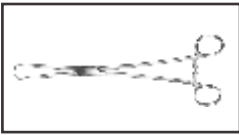
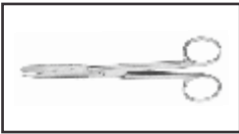
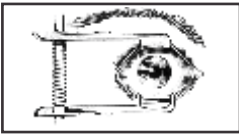

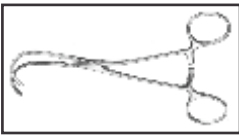
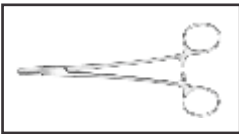
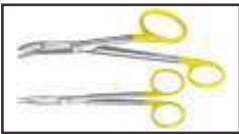
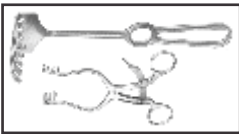

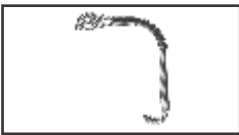

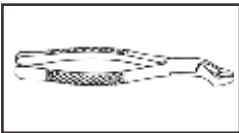

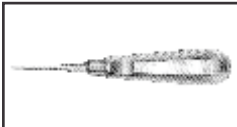

WE DEAL IN ALL KINDS OF

**SURGICAL**

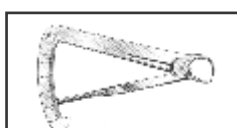
INSTRUMENTS

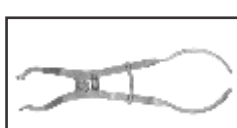
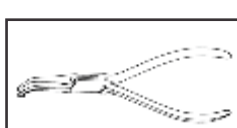
<b>01S</b>		<b>DIAGNOSTIC INSTRUMENTS</b>	<b>10S</b>		<b>NEURO SURGERY INSTRUMENTS</b>
	PAGE 1 TO 3			PAGE 52 TO 57	
<b>02S</b>		<b>HEMOSTATIC INSTRUMENTS</b>	<b>11S</b>		<b>BONE SURGERY INSTRUMENTS</b>
	PAGE 4 TO 11			PAGE 58 TO 73	
<b>03S</b>		<b>TOWEL CLAMPS</b>	<b>12S</b>		<b>GYNECOLOGICAL &amp; OBSTETRICAL INSTRUMENTS</b>
	PAGE 12			PAGE 74 TO 84	
<b>04S</b>		<b>SCISSORS</b>	<b>13S</b>		<b>EYE INSTRUMENTS</b>
	PAGE 13 TO 17			PAGE 85 TO 94	
<b>05S</b>		<b>DRESSING &amp; TISSUE FORCEPS</b>	<b>14S</b>		<b>ATRAUMATIC INSTRUMENTS</b>
	PAGE 18 TO 22			PAGE 95 TO 96	
<b>06S</b>		<b>NEEDLE HOLDER</b>	<b>15S</b>		<b>TONGSTEN CARBIDE INSTRUMENTS (T.C)</b>
	PAGE 23 TO 25			PAGE 97 TO 107	
<b>07S</b>		<b>RETRACTORS</b>	<b>16S</b>		<b>LASER SURGERY INSTRUMENTS</b>
	PAGE 26 TO 34			PAGE 108 TO 111	
<b>08S</b>		<b>ORAL INSTRUMENTS</b>	<b>17S</b>		<b>HOLLOWARE</b>
	PAGE 35 TO 37			PAGE 112 TO 114	
<b>09S</b>		<b>E.N.T INSTRUMENTS</b>	<b>01D</b>		<b>EXTRACTING FORCEPS</b>
	PAGE 38 TO 51			PAGE 115 TO 117	

<b>02D</b>		<b>ELEVATORS</b>	<b>01E</b>		<b>E.M.S</b>
	PAGE 118 TO 121			142 TO 145	
<b>03D</b>		<b>MIRROR + HANDLE</b>	<b>01V</b>		<b>VETERINARY INSTRUMENTS</b>
	PAGE 122			PAGE 146 TO 148	
<b>04D</b>		<b>AMALGAM CARRIERS &amp; SYRINGES</b>			<b>DIAGNOSTIC INSTRUMENTS</b>
	PAGE 123 TO 124			PAGE 149	
<b>05D</b>		<b>MISCELLANEOUS</b>			
	PAGE 125				
<b>06D</b>		<b>TUFFLIMIRE, CALIPERS ETC</b>			
	PAGE 126				
<b>07D</b>		<b>GENERAL DENTISTRY INSTRUMENTS</b>			
	PAGE 127 TO 135				
<b>08D</b>		<b>RUBBER DAM FORCEPS &amp; CLAMPS</b>			
	PAGE 136 TO 137				
<b>09D</b>		<b>PLIERS</b>			
	PAGE 138 TO 139				
<b>10D</b>		<b>IMPRESSION TRAY</b>			
	140 TO 141				

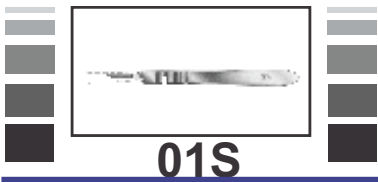

# DIAGNOSTIC INSTRUMENTS



Box of 100 Pcs

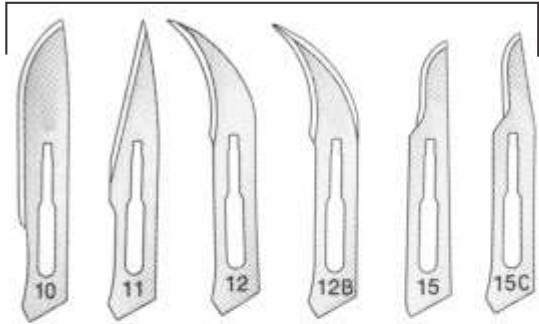

(Fits handles # 3, 3L, 3LA, 7, 9,)

01S-001 01S-002 01S-003 01S-004 01S-005 01S-006

**Carbon Steel Sterile Surgical Blades**

Box of 100 Pcs

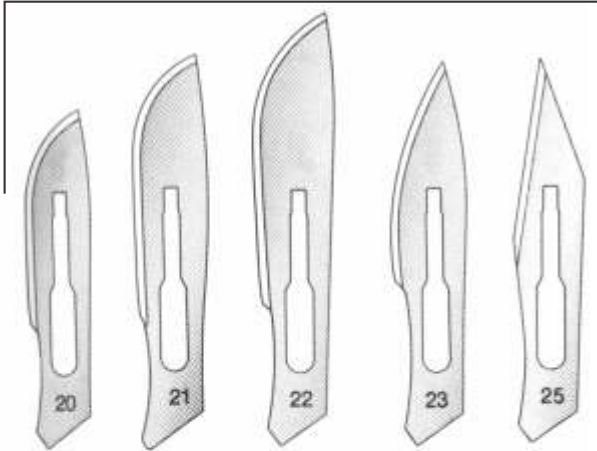

(Fits handles # 4, 4L,)

01S-007 01S-008 01S-009 01S-010 01S-011

**Carbon Steel Sterile Surgical Blades**

## Scalpel Handles

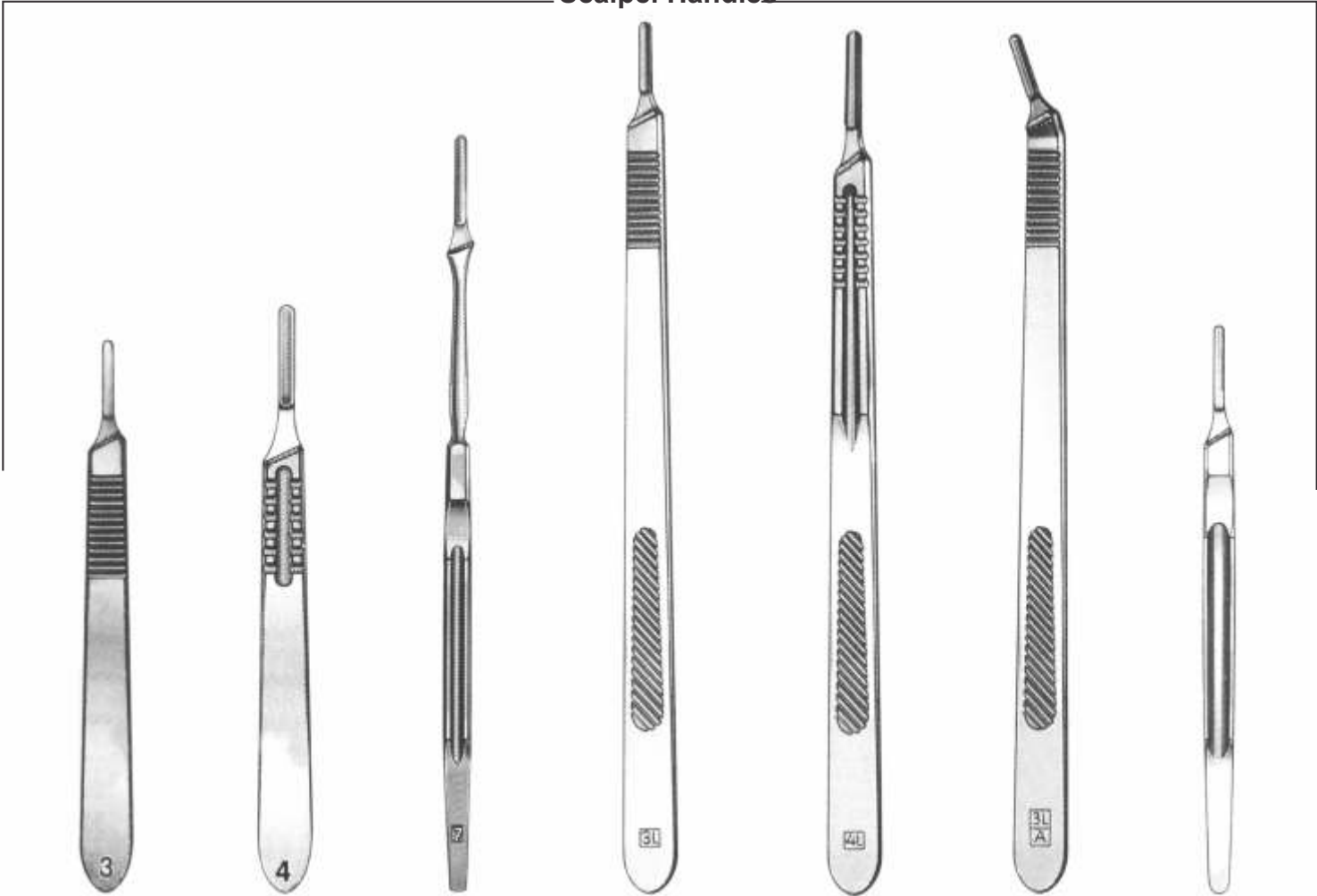

#3

01S5-012

#4

01S-013

#7

01S-014

#3L

01S-015

#4L

01S-016

#3LA

01S-017

#9

01S-018



01S

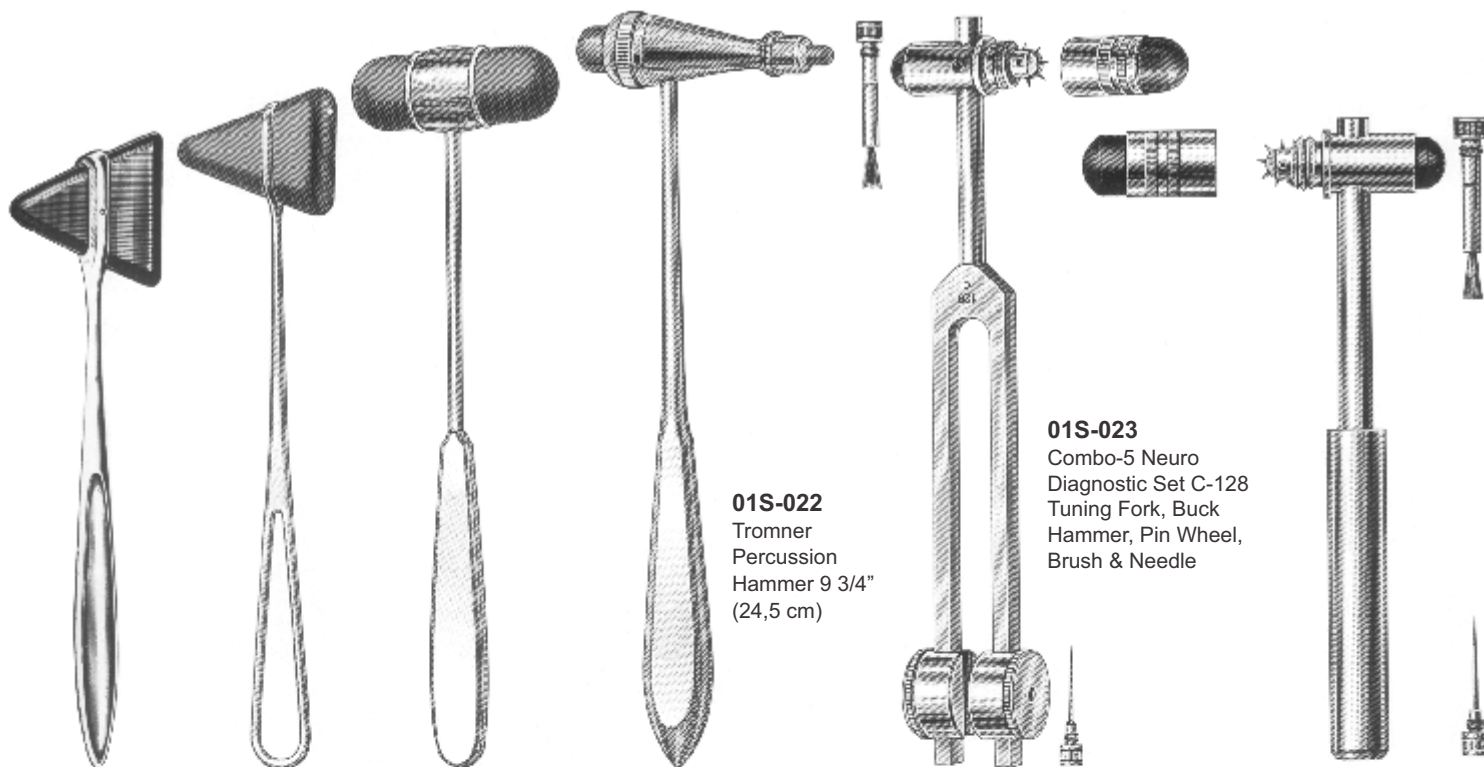

01S-019

Taylor Percussion Hammer  
7 1/2" (19 cm)

01S-020

Taylor Percussion Hammer  
9" (22 cm)

01S-021

Dejerine Percussion Hammer  
9 1/2" (24 cm)

01S-022  
Tromner  
Percussion  
Hammer 9 3/4"  
(24,5 cm)

01S-023  
Combo-5 Neuro  
Diagnostic Set C-128  
Tuning Fork, Buck  
Hammer, Pin Wheel,  
Brush & Needle

01S-024  
Combo-4 Neuro  
Diagnostic Set Buck  
Hammer,  
Pin Wheel, Brush &  
Needle

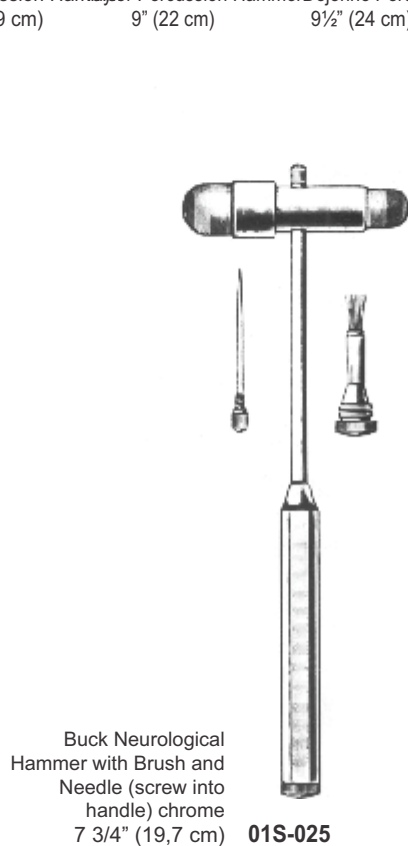

Buck Neurological  
Hammer with Brush and  
Needle (screw into  
handle) chrome  
7 3/4" (19,7 cm)

01S-025

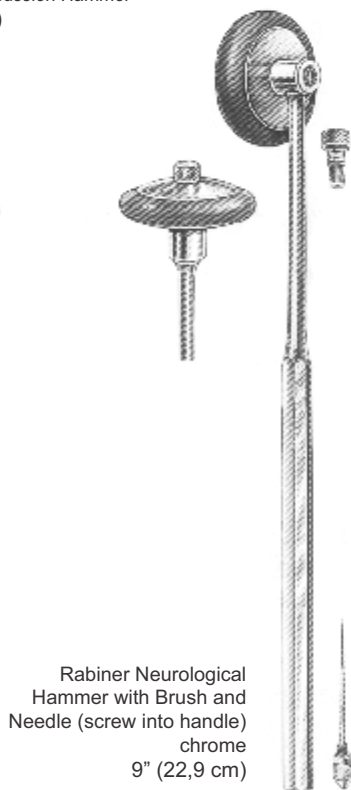

Rabiner Neurological  
Hammer with Brush and  
Needle (screw into handle)  
chrome  
9" (22,9 cm)

01S-026

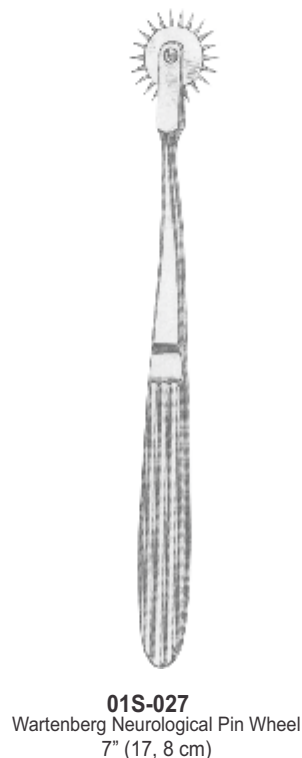

01S-027  
Wartenberg Neurological Pin Wheel  
7" (17, 8 cm)

**01S**



Probes, Double End

ARTICLE #	SIZE
01S-028	4 1/2" (11,4 cm)
01S-029	5" (12,7 cm)
01S-030	5 1/2" (14 cm)
01S-031	6" (15,2 cm)
01S-032	7" (17,8 cm)
01S-033	8" (20,3 cm)
01S-034	10" (25,4 cm)



Probes, With Eye

ARTICLE #	SIZE
01S-035	4 1/2" (11,4 cm)
01S-036	5" (12,7 cm)
01S-037	5 1/2" (14 cm) 6"
01S-038	(15,2 cm) 7"
01S-039	(17,8 cm) 8"
01S-040	(20,3 cm) 10"
01S-041	(25,4 cm)



**01S-042**  
Probe with  
Myrtle Leaf 5"  
(12,7 cm)



Grooved Directors With Tongue Tie

ARTICLE #	SIZE
01S-043	4 1/2" (11,4 cm)
01S-044	5" (12,7 cm)
01S-045	5 1/2" (14 cm)
01S-046	6" (15,2 cm)
01S-047	8" (20,3 cm)



Grooved Directors With Probe Tip  
& Tongue Tie

ARTICLE #	SIZE
01S-048	4 1/2" (11,4 cm)
01S-049	5" (12,7 cm)
01S-050	5 1/2" (14 cm)
01S-051	6" (15,2 cm)
01S-052	8" (20,3 cm)



**01S-053**  
Larry Probe and Grooved  
Director 7" (17,8 cm)



**01S-054**

Pinard Fetal Head Stethoscope (Aluminum)

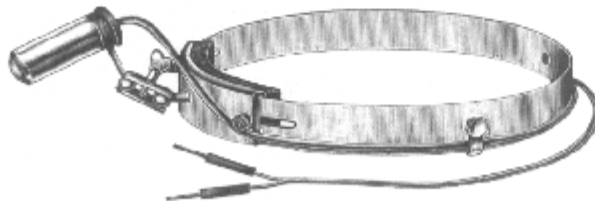

**01S-055**  
Head Light



**01S-056**  
Mirror Head

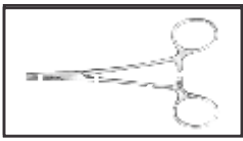

02S

# HEMOSTATIC INSTRUMENTS

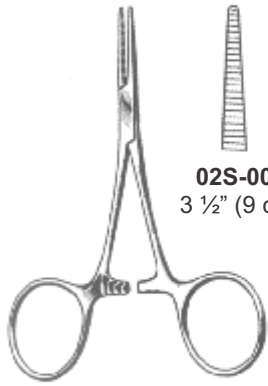

**02S-001** 3 1/2" (9 cm)  
**02S-002** 3 1/2" (9 cm)

Baby-Mosquito Forceps (HARTMANN)

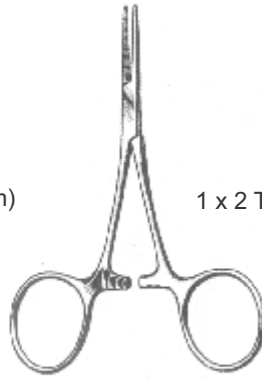

1 x 2 Teeth  
**02S-003** 3 1/2" (10 cm)  
**02S-004** 3 1/2" (10 cm)  
**02S-005** 3 1/2" (10 cm)  
**02S-006** 3 1/2" (10 cm)

Micro-Mosquito Forceps

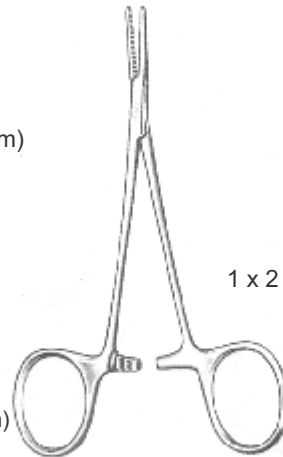

1 x 2 Teeth  
**02S-007** 5" (12 cm)  
**02S-008** 5" (12 cm)  
**02S-009** 5" (12 cm)  
**02S-010** 5" (12 cm)

Micro-Halstead-Mosquito Forceps

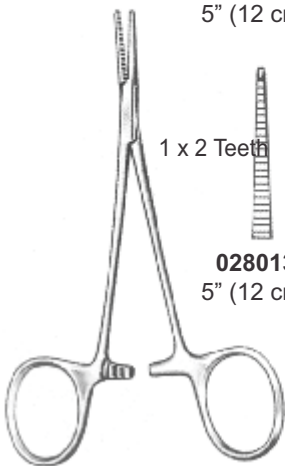

Serrated  
**02S-011** 5" (12 cm)  
**02S-012** 5" (12 cm)  
1 x 2 Teeth  
**028013** 5" (12 cm)  
**02S-014** 5" (12 cm)

Halstead-Mosquito Forceps

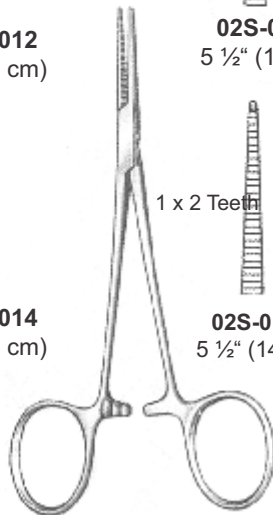

Serrated  
**02S-015** 5 1/2" (14 cm)  
**02S-016** 5 1/2" (14 cm)  
1 x 2 Teeth  
**02S-017** 5 1/2" (14 cm)  
**02S-018** 5 1/2" (14 cm)

Halstead-Mosquito Forceps

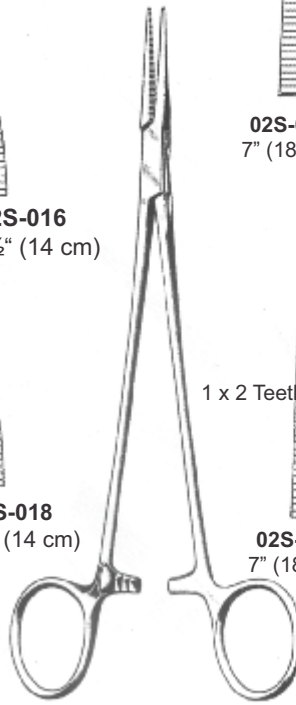

Serrated  
**02S-019** 7" (18 cm)  
**02S-020** 8" (20 cm)  
**02S-021** 7" (18 cm)  
**02S-022** 8" (20 cm)  
1 x 2 Teeth  
**02S-023** 7" (18 cm)  
**02S-024** 8" (20 cm)  
**02S-025** 7" (18 cm)  
**02S-026** 8" (20 cm)

Halstead-Mosquito Forceps

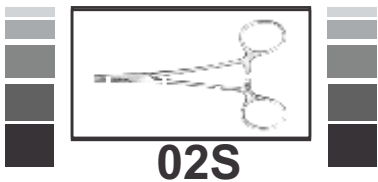

# HEMOSTATIC INSTRUMENTS



Kelly Hemostatic Forceps

**02S-027**  
5 1/2" (14 cm)



**02S-028**  
5 1/2" (14 cm)

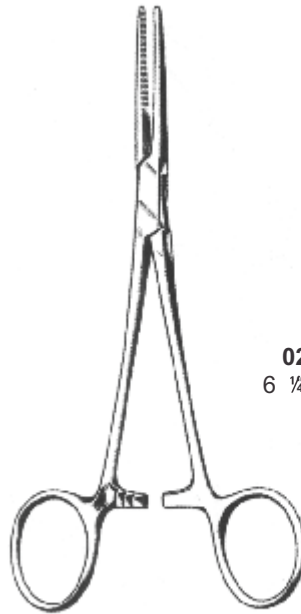

Kelly-Rankin Hemostatic Forceps

**02S-029**  
6 1/4" (16 cm)



**02S-030**  
6 1/4" (16 cm)

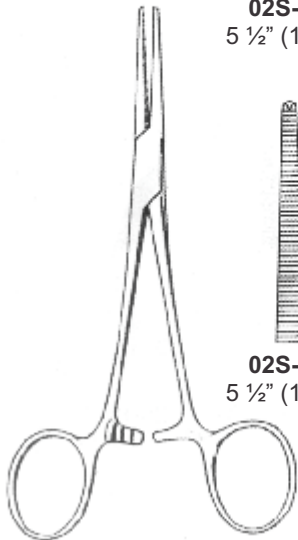

Crile-Hemostatic Forceps

**02S-031**  
5 1/2" (14 cm)



**02S-032**  
5 1/2" (14 cm)

**02S-033**  
5 1/2" (14 cm)

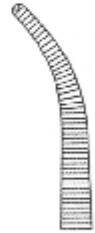

**02S-034**  
5 1/2" (14 cm)

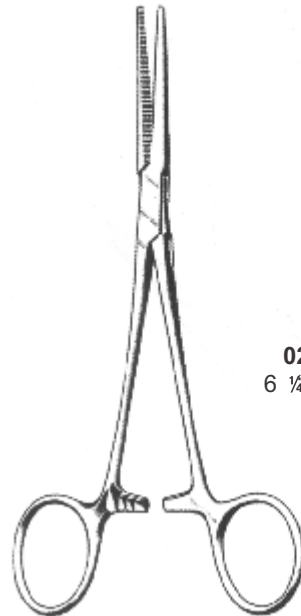

Crile-Rankin Hemostatic Forceps

**02S-035**  
6 1/4" (16 cm)

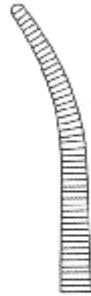

**02S-036**  
6 1/4" (16 cm)

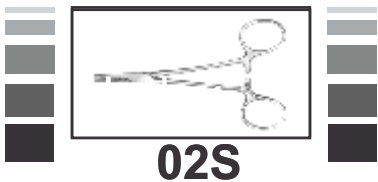

# HEMOSTATIC INSTRUMENTS



Kocher Hemostatic Forceps 1 x 2 Teeth



Rochester Pean Forceps Serrated

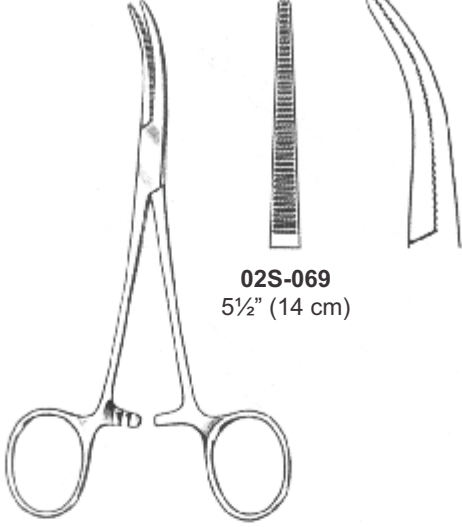

Dandy Hemostatic Forceps

**02S-069**  
5 1/2" (14 cm)

ARTICLE #	Size	ARTICLE #
Straight		Curved
02S-037	5 1/2" (14 cm)	02S-045
02S-038	6 1/4" (16 cm)	02S-046
02S-039	7" (18 cm)	02S-047
02S-040	8" (20 cm)	02S-048
02S-041	8 3/4" (22 cm)	02S-049
02S-042	9 1/2" (24 cm)	02S-050
02S-043	10 1/4" (26 cm)	02S-051
02S-044	12" (30 cm)	02S-052

ARTICLE #	Size	ARTICLE #
Straight		Curved
02S-053	5 1/2" (14 cm)	02S-061
02S-054	6 1/4" (16 cm)	02S-062
02S-055	7" (18 cm)	02S-063
02S-056	8" (20 cm)	02S-064
02S-057	8 3/4" (22 cm)	02S-065
02S-058	9 1/2" (24 cm)	02S-066
02S-059	10 1/4" (26 cm)	02S-067
02S-060	12" (30 cm)	02S-068

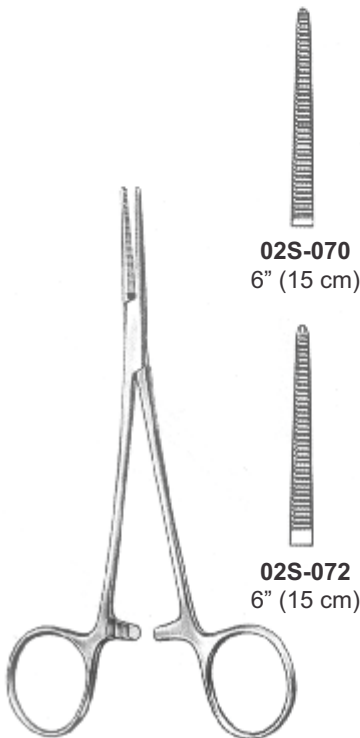

Leriche Hemostatic Forceps

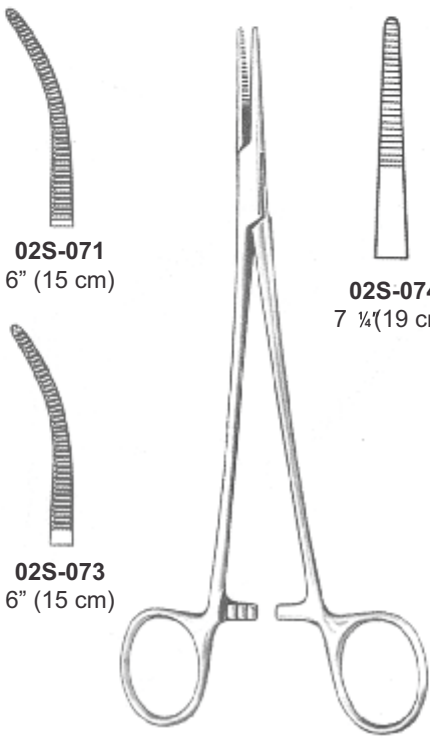

Adson Hemostatic Forceps

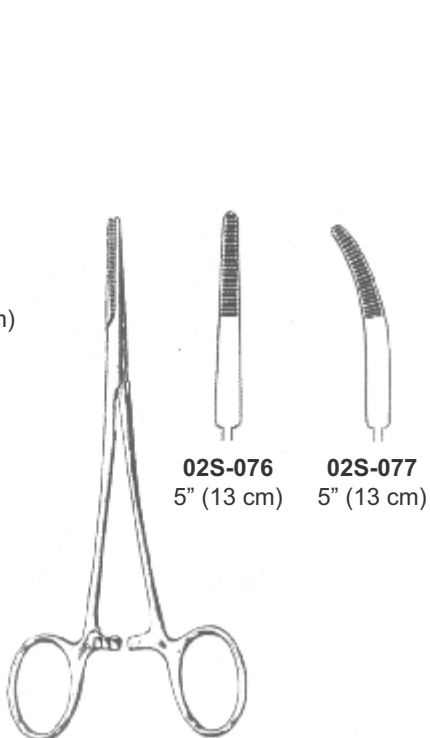

Providence-Hospital Hemostatic Forceps

**02S-070**  
6" (15 cm)

**02S-071**  
6" (15 cm)

**02S-074**  
7 1/4" (19 cm)

**02S-075**  
7 1/4" (19 cm)

**02S-072**  
6" (15 cm)

**02S-073**  
6" (15 cm)

**02S-076**  
5" (13 cm)

**02S-077**  
5" (13 cm)



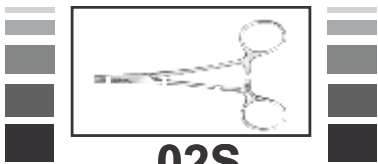

# HEMOSTATIC INSTRUMENTS



02S



Spencer-Wells Artery Forceps

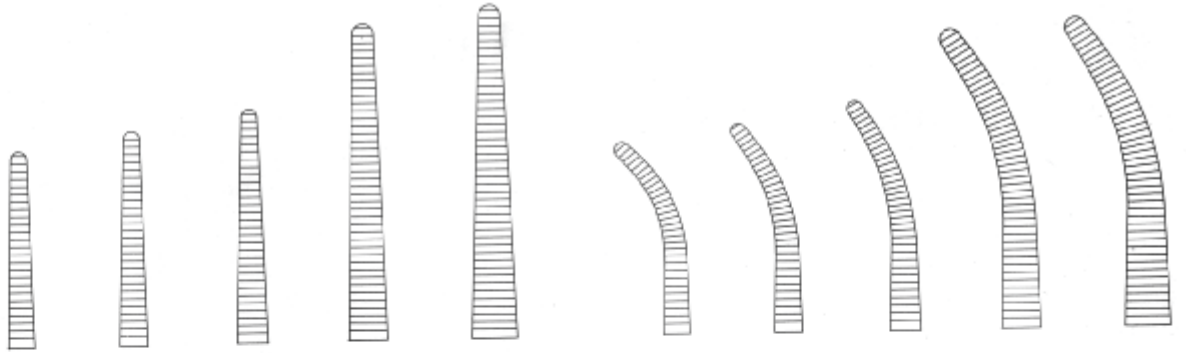

02S-078 5" (13 cm)    02S-079 5 1/2" (14 cm)    02S-080 6" (15 cm)    02S-081 7" (18 cm)    02S-082 8" (20 cm)    02S-083 5" (13 cm)    02S-084 5 1/2" (14 cm)    02S-085 6" (15 cm)    02S-086 7" (18 cm)    02S-087 8" (20 cm)



Rochester-Carmalt Forceps

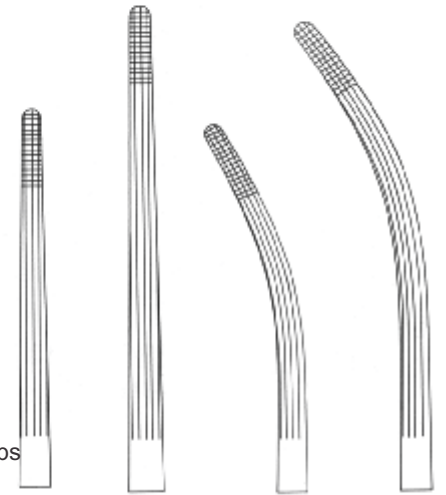

02S-088 6 1/4" (20 cm)    02S-089 8" (20 cm)    02S-090 6 1/4" (20 cm)    02S-091 8" (20 cm)

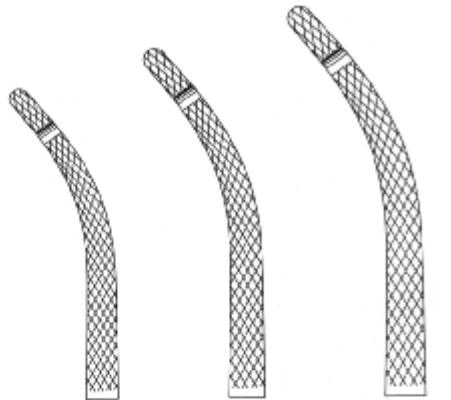

02S-092 7 3/4" (19,5 cm)    02S-093 8 1/4" (21 cm)    02S-094 9" (23 cm)



Heaney Hemostatic Forceps

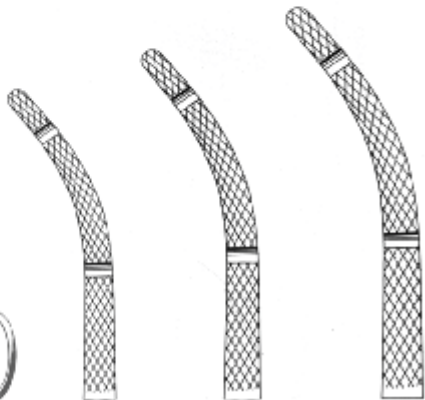

02S-095 7 3/4" (19,5 cm)    02S-096 8 1/4" (21 cm)    02S-097 9" (23 cm)



Mixer Artery Forceps

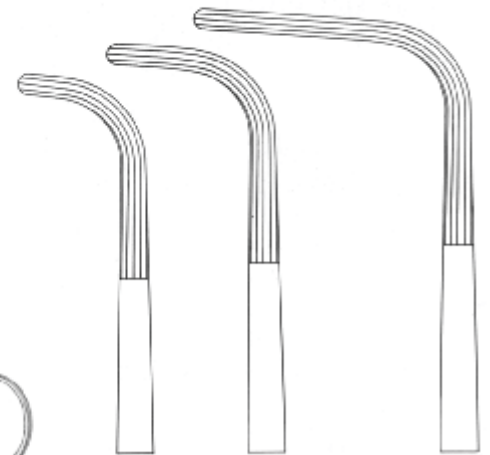

02S-098 8 3/4" (23 cm)    02S-099 10" (25 cm)    02S-100 11" (28 cm)

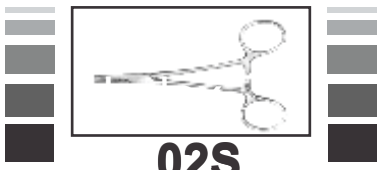

# HEMOSTATIC INSTRUMENTS

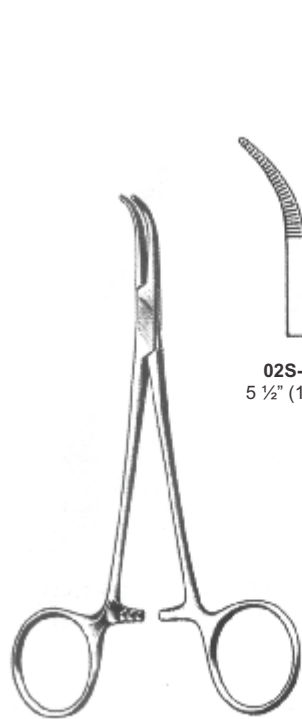

Baby-Mixer Forceps



Baby-Mixer Forceps



Baby-Mixer Forceps



**02S-105**  
Mixer Oschner Artery  
Forceps  
7 1/2" (19 cm)

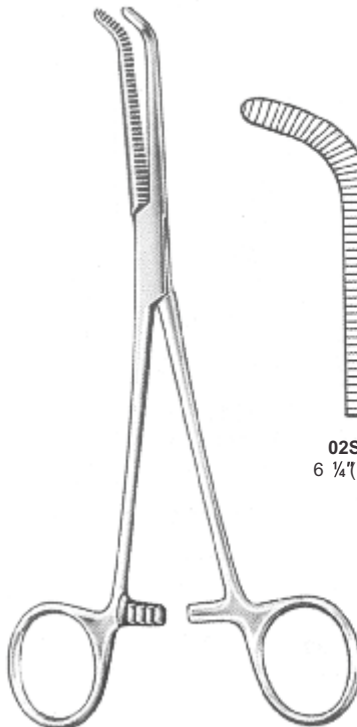

Mixer Artery Forceps

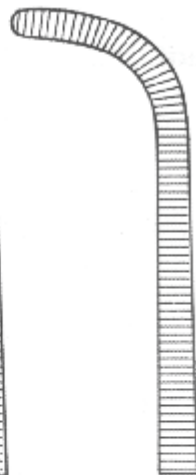
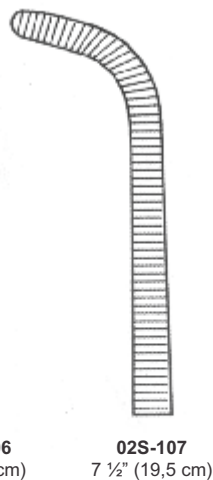
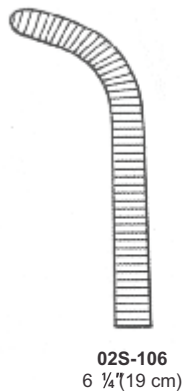

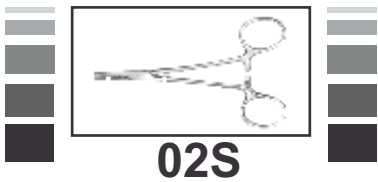

# HEMOSTATIC INSTRUMENTS



Gemini Hemostatic Forceps

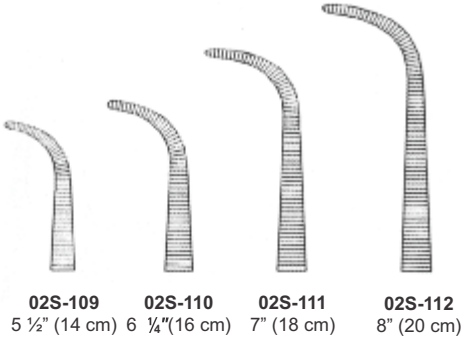

02S-109 5 1/2" (14 cm)  
 02S-110 6 1/4" (16 cm)  
 02S-111 7" (18 cm)  
 02S-112 8" (20 cm)

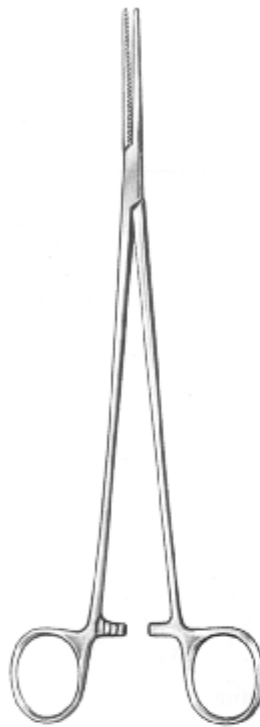

Bangolea Hemostatic Forceps

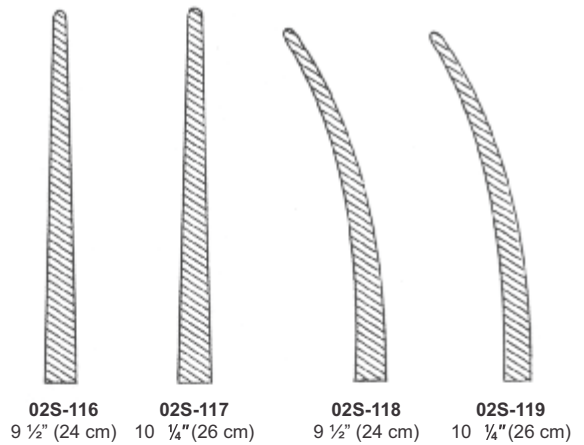

02S-116 9 1/2" (24 cm)  
 02S-117 10 1/4" (26 cm)  
 02S-118 9 1/2" (24 cm)  
 02S-119 10 1/4" (26 cm)

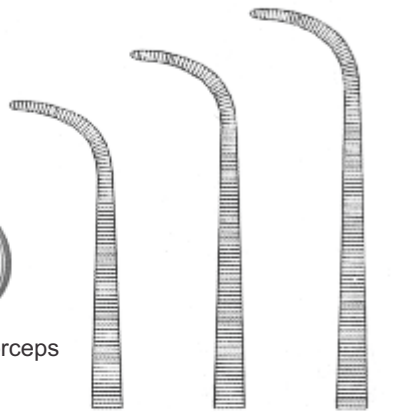

02S-113 9" (23 cm)  
 02S-114 10" (25 cm)  
 02S-114 11" (28 cm)

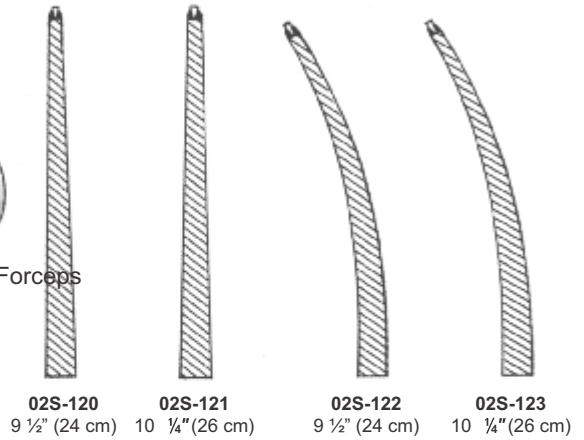

02S-120 9 1/2" (24 cm)  
 02S-121 10 1/4" (26 cm)  
 02S-122 9 1/2" (24 cm)  
 02S-123 10 1/4" (26 cm)



02S-124  
 Baby-Mikulicz  
 Peritoneal Clamp  
 Forceps  
 5 1/2" (14 cm)

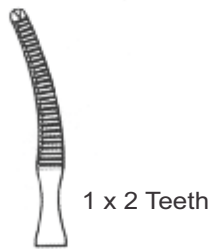

1 x 2 Teeth



02S-125  
 Mikulicz  
 Peritoneal  
 Clamp  
 Forceps  
 8" (20,5 cm)



1 x 2 Teeth

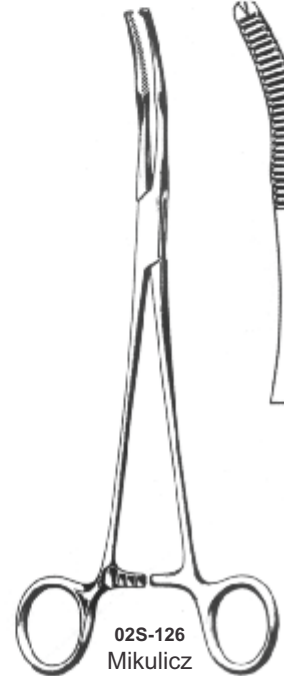

02S-126  
 Mikulicz  
 Peritoneal  
 Clamp  
 Forceps  
 8 1/2" (21,5 cm)

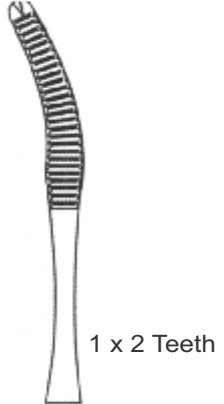

1 x 2 Teeth

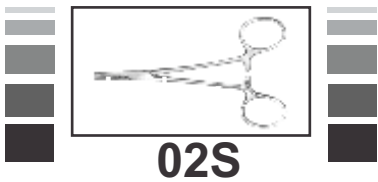

# HEMOSTATIC INSTRUMENTS



2x3 Teeth    3x4 Teeth    4x5 Teeth    4x5 Teeth    5x6 Teeth    6x7 Teeth

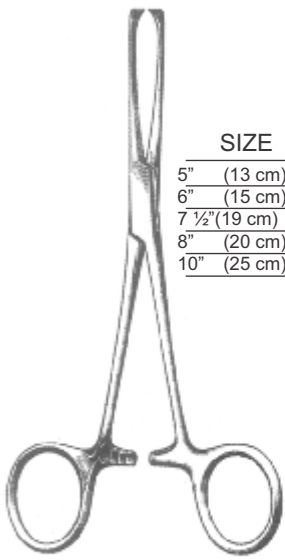

Allis Forceps

SIZE	Allis	Judd-Allis	Baby-Allis	Allis	Allis	Thomas-Allis
5" (13 cm)	02S-127	02S-132	02S-137	02S-142	02S-147	02S-152
6" (15 cm)	02S-128	02S-133	02S-138	02S-143	02S-148	02S-153
7 1/2" (19 cm)	02S-129	02S-134	02S-139	02S-144	02S-149	02S-154
8" (20 cm)	02S-130	02S-135	02S-140	02S-145	02S-150	02S-155
10" (25 cm)	02S-131	02S-136	02S-141	02S-146	02S-151	02S-156

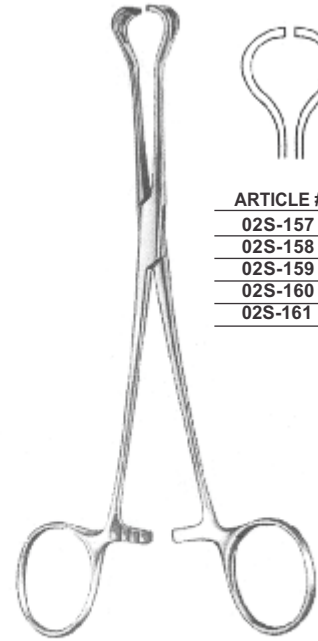

Babcock Forceps

ARTICLE #	SIZE
02S-157	5.5" (14,5 cm)
02S-158	6.5" (16 cm)
02S-159	7" (18 cm)
02S-160	8.5" (21 cm)
02S-161	9.5" (24 cm)

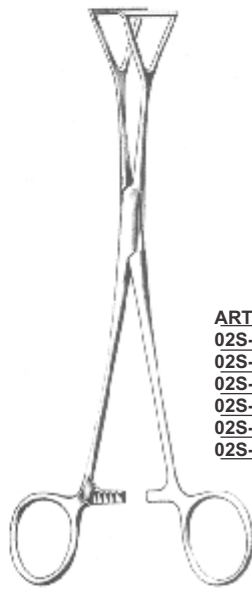

Duval Forceps

ARTICLE #	A (mm)	SIZE
02S-164	14 mm	8" (20 cm)
02S-165	18 mm	8" (20 cm)
02S-166	28 mm	8" (20 cm)
02S-167	14 mm	9" (23 cm)
02S-168	18 mm	9" (23 cm)
02S-169	28 mm	9" (23 cm)

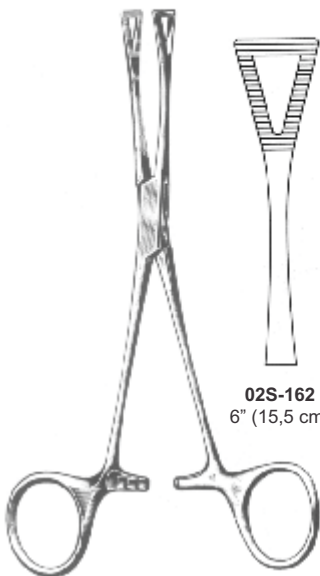

Pennington Forceps

02S-162  
6" (15,5 cm)



02S-162  
8" (20 cm)

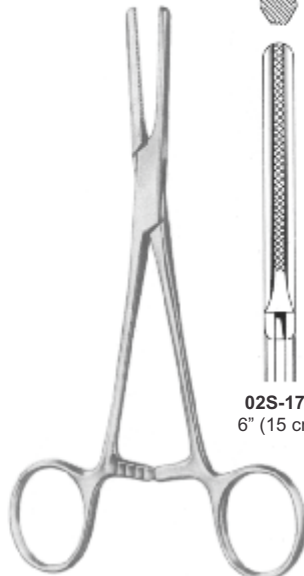

Tube Occluding Forceps

02S-170  
6" (15 cm)

02S-171  
7" (18 cm)

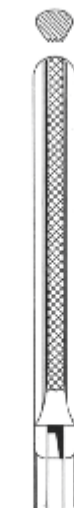

02S-172  
8" (20 cm)

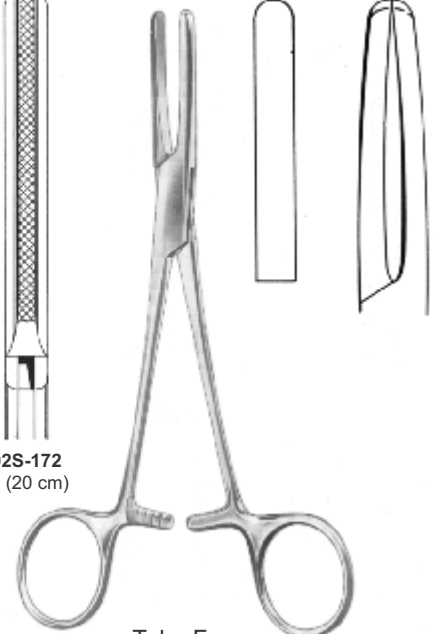

Tube Forceps

ARTICLE #	SIZE
02S-173	5 1/2" (14 cm)
02S-174	6 1/2" (16,5 cm)
02S-175	7 1/4" (18 cm)

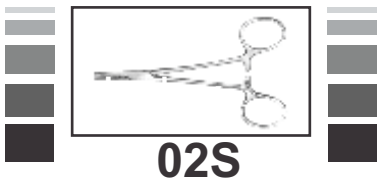

# HEMOSTATIC INSTRUMENTS

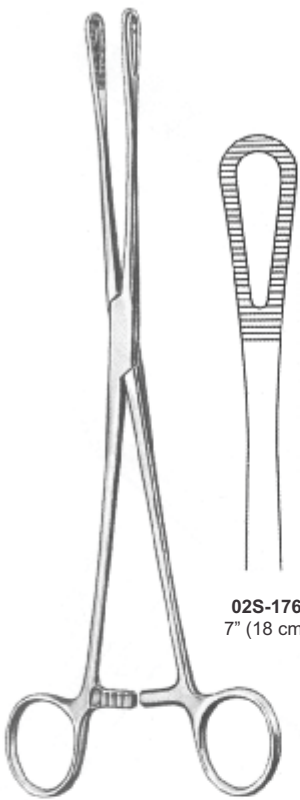

**02S-176**  
7" (18 cm)

Rampley Sponge Forceps



**02S-177**  
10" (25 cm)

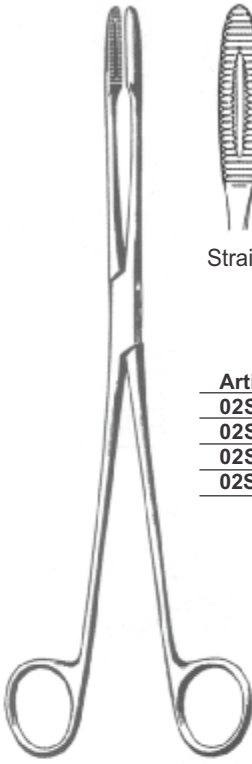

Gross-Maier Dressing Forceps

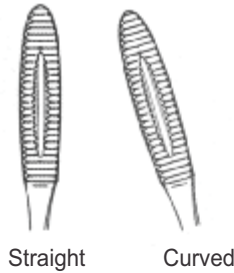

Article #	Size
<b>02S-178</b>	8" (20 cm)
<b>02S-179</b>	9" (23 cm)
<b>02S-180</b>	10" (25 cm)
<b>02S-181</b>	10 1/2" (27 cm)

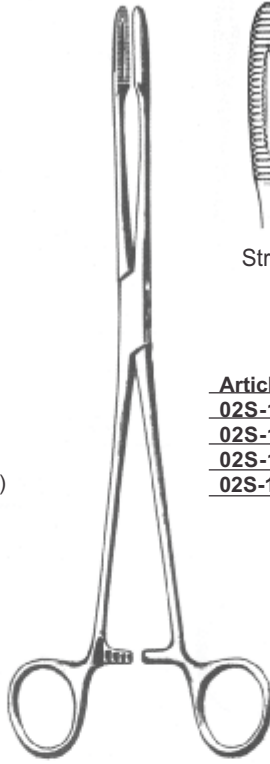

Gross-Maier Dressing Forceps

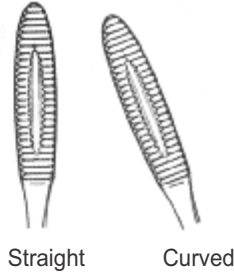

Article #	Size
<b>02S-182</b>	8" (20 cm)
<b>02S-183</b>	9" (23 cm)
<b>02S-184</b>	10" (25 cm)
<b>02S-185</b>	10 1/2" (27 cm)

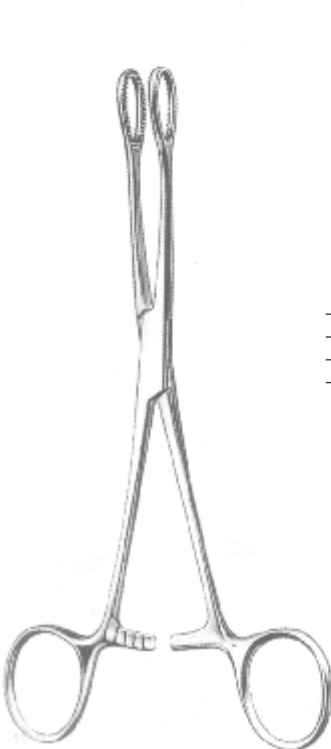

Foerster Sponge Forceps

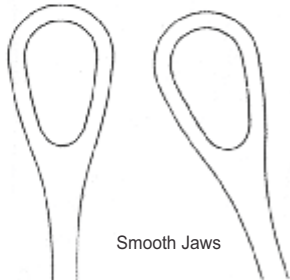

Smooth Jaws

Article #	Size	Article #	Size
<b>02S-186</b>	7" (18 cm)	<b>02S-189</b>	7" (18 cm)
<b>02S-187</b>	8" (20 cm)	<b>02S-190</b>	8" (20 cm)
<b>02S-188</b>	10" (25 cm)	<b>02S-191</b>	10" (25 cm)

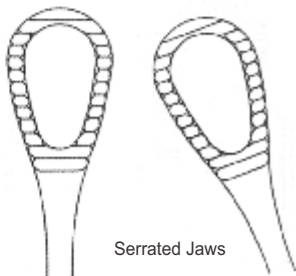

Serrated Jaws

Article #	Size	Article #	Size
<b>02S-192</b>	7" (18 cm)	<b>02S-195</b>	7" (18 cm)
<b>02S-193</b>	8" (20 cm)	<b>02S-196</b>	8" (20 cm)
<b>02S-194</b>	10" (25 cm)	<b>02S-197</b>	10" (25 cm)

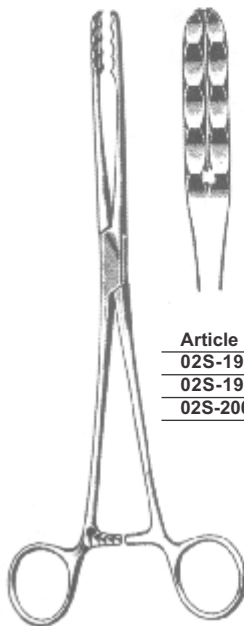

Ulrich Cotton Swab Forceps

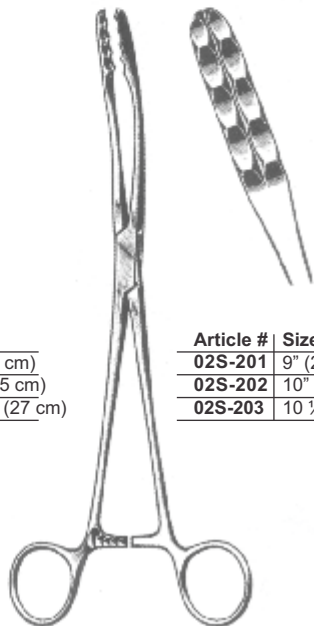

Ulrich Cotton Swab Forceps

Article #	Size
<b>02S-198</b>	9" (23 cm)
<b>02S-199</b>	10" (25 cm)
<b>02S-200</b>	10 1/2" (27 cm)

Article #	Size
<b>02S-201</b>	9" (23 cm)
<b>02S-202</b>	10" (25 cm)
<b>02S-203</b>	10 1/2" (27 cm)



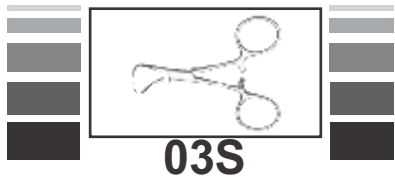

**03S**

# TOWEL CLAMPS

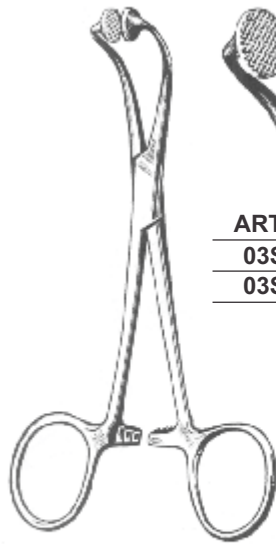

Hoff Towel Clamp  
Stainless Steel

ARTICLE #	SIZE
03S-001	4" (10 cm)
03S-002	5 3/4" (14.5 cm)



**03S-003**  
Roeder Towel  
Clamp with  
Ball Stop  
5" (13 cm)



**03S-004**  
Jones Towel  
Clamp  
3 1/2" (9 cm)

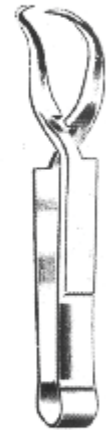

**03S-005**  
Schaedel Towel  
Clamp  
3 1/2" (9 cm)



Ball & Socket Towel Clamp

ARTICLE #	SIZE
03S-006	3 3/4" (10 cm)
03S-007	5 1/2" (14 cm)
03S-008	6" (15 cm)



Lorna Towel Clamp

ARTICLE #	SIZE
03S-009	4" (10 cm)
03S-010	5" (13 cm)

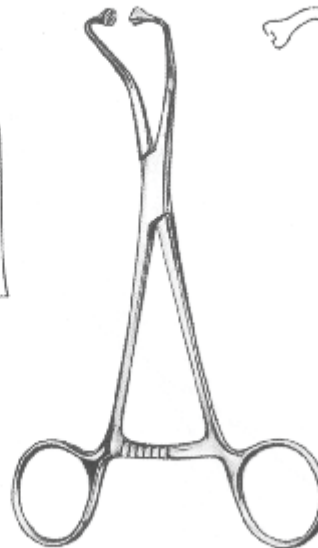

**03S-011**  
Peers Towel  
Clamp 5 "  
(14.5 cm)

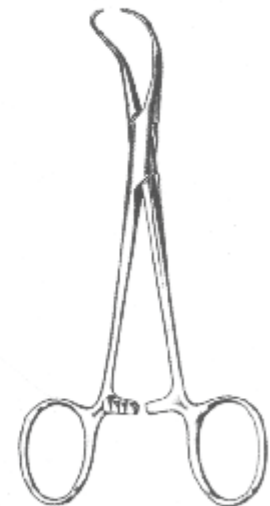

Backhaus Towel Clamp

ARTICLE #	SIZE
03S-012	3.5" (9 cm)
03S-013	4 1/2" (11 cm)
03S-014	5" (13 cm)
03S-015	6" (15 cm)

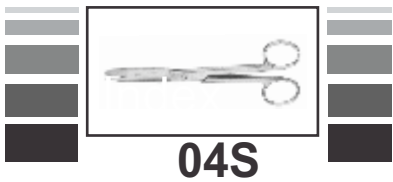

**04S**

# SCISSORS

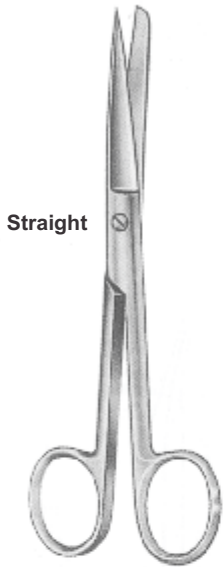

**Straight**

Operating Scissors

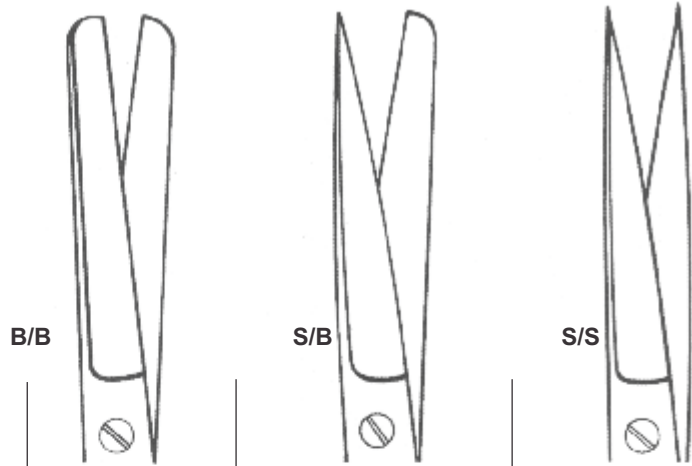

SIZE	B/B	S/B	S/S
4¼" (10.5 cm)	04S-001	04S-010	04S-019
4¾" (11.5 cm)	04S-002	04S-011	04S-020
5" (13.0 cm)	04S-003	04S-012	04S-021
5½" (14.5 cm)	04S-004	04S-013	04S-022
6" (15.5 cm)	04S-005	04S-014	04S-023
6 ½" (16.5 cm)	04S-006	04S-015	04S-024
7" (17.5 cm)	04S-007	04S-016	04S-025
7¼" (18.5 cm)	04S-008	04S-017	04S-026
8" (20.0 cm)	04S-009	04S-018	04S-027

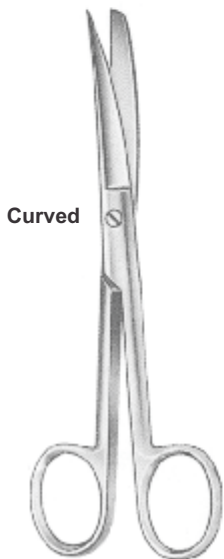

**Curved**

Operating Scissors

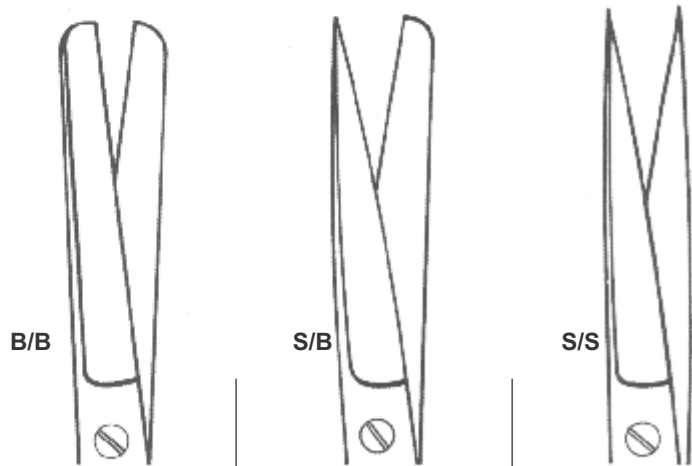

SIZE	B/B	S/B	S/S
4¼" (10.5 cm)	04S-028	04S-037	04S-046
4¾" (11.5 cm)	04S-029	04S-038	04S-047
5" (13.0 cm)	04S-030	04S-039	04S-048
5½" (14.5 cm)	04S-031	04S-040	04S-049
6" (15.5 cm)	04S-032	04S-041	04S-050
6 ½" (16.5 cm)	04S-033	04S-042	04S-051
7" (17.5 cm)	04S-034	04S-043	04S-052
7¼" (18.5 cm)	04S-035	04S-044	04S-053
8" (20.0 cm)	04S-036	04S-045	04S-054

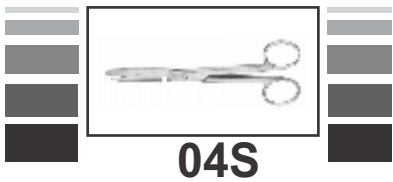

# SCISSORS



## Straight

## Curved

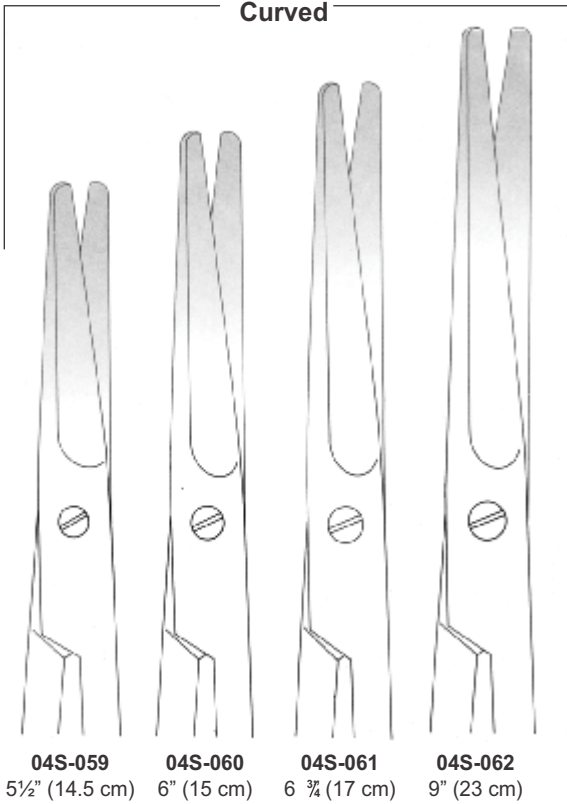
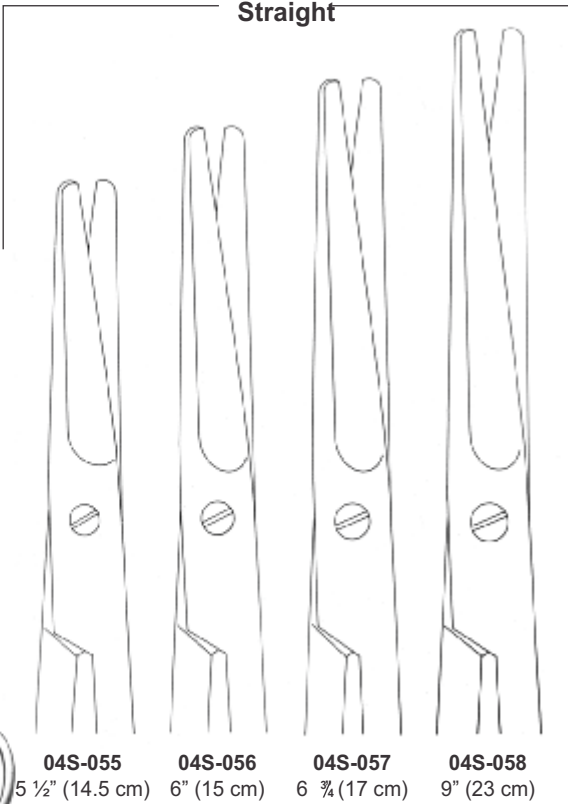

Mayo Dressing Scissors

## Straight

## Curved

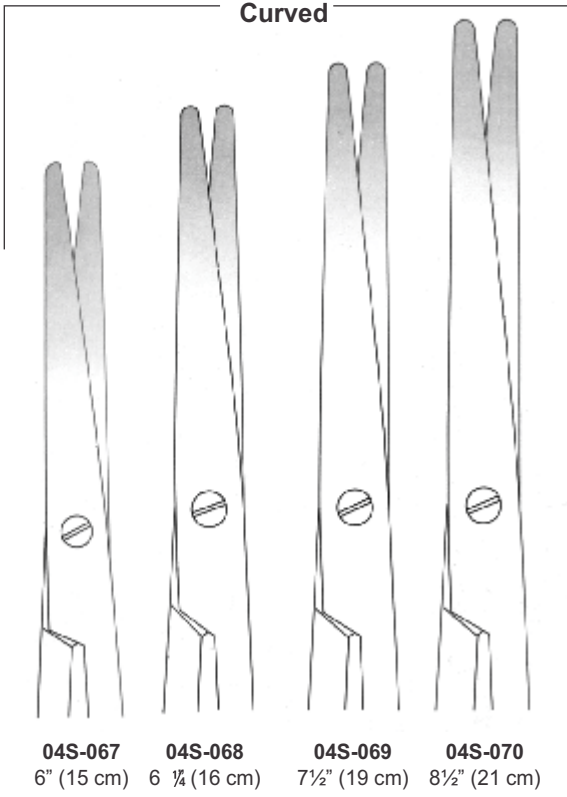
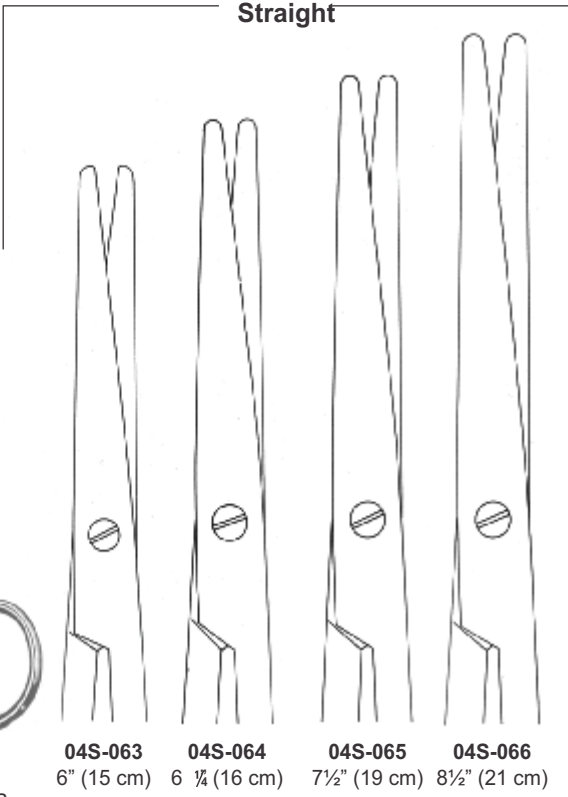

Mayo-Stillé Dressing Scissors

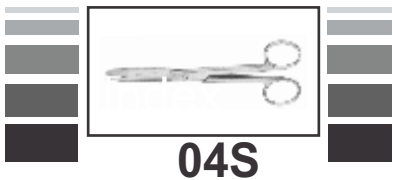

**04S**

# SCISSORS



Straight

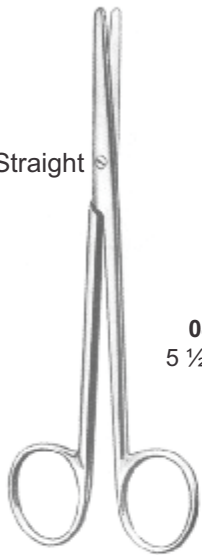

Metzenbaum Scissors



**04S-071**  
5 1/2" (14 cm)



**04S-072**  
7" (18 cm)



**04S-073**  
8" (20 cm)



**04S-074**  
9" (23 cm)



**04S-075**  
10" (25 cm)



**04S-076**  
11" (28 cm)



**04S-077**  
12" (30 cm)

Curved

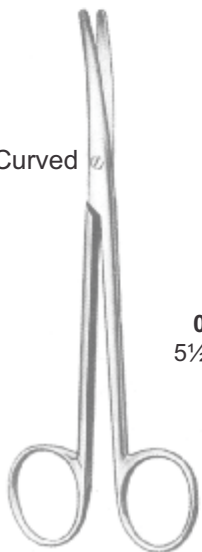

Metzenbaum Scissors



**04S-078**  
5 1/2" (14 cm)



**04S-079**  
7" (18 cm)



**04S-080**  
8" (20 cm)



**04S-081**  
9" (23 cm)



**04S-082**  
10" (25 cm)



**04S-083**  
11" (28 cm)



**04S-084**  
12" (30 cm)

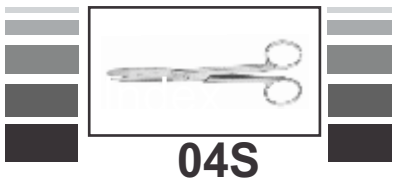

# SCISSORS

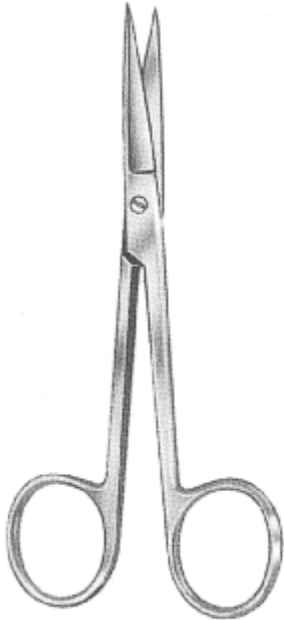

Iris Scissors

ARTICLE # Straight	ARTICLE # Curved	SIZE
04S-085	04S-088	3 1/2" (9 cm)
04S-086	04S-089	4" (10 cm)
04S-087	04S-090	4 1/2" (11 cm)



Stevens Strabismus Scissors

ARTICLE # Straight	ARTICLE # Curved	SIZE
04S-091	04S-093	4" (10 cm)
04S-092	04S-094	4 1/2" (11 cm)

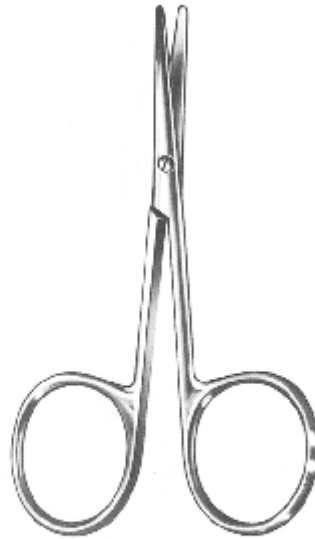

Lexer-Baby Scissors

ARTICLE # Straight	SIZE
04S-095	4 1/4" (11 cm)
04S-096	5" (12,5 cm)

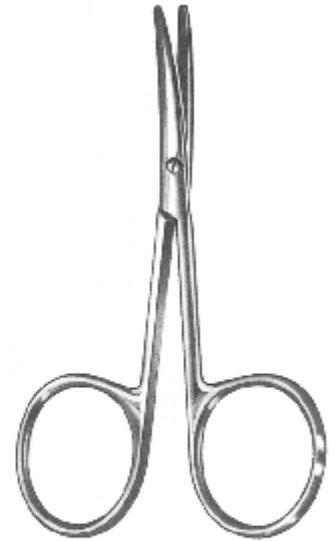

Lexer-Baby Scissors

ARTICLE # Curved	SIZE
04S-097	4 1/4" (11 cm)
04S-098	5" (12,5 cm)

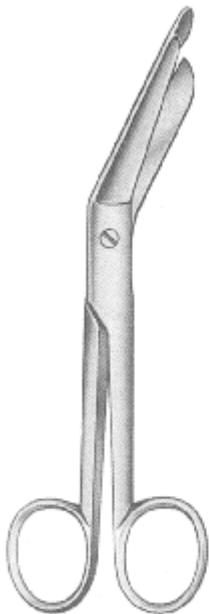

Lister Bandage Scissors

ARTICLE #	SIZE
04S-099	3 1/2" (9 cm)
04S-100	4 1/2" (11 cm)
04S-101	5 1/2" (14 cm)
04S-102	7" (18 cm)
04S-103	8" (20 cm)

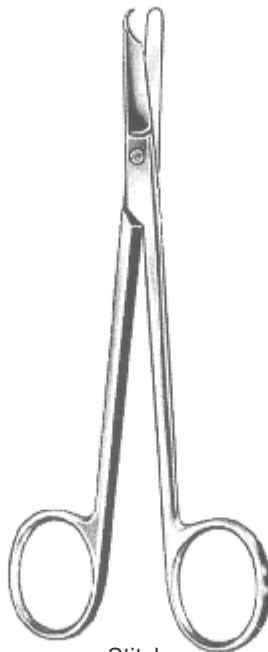

Stitch  
Ligature Scissors

ARTICLE #	SIZE
04S-104	3 1/2" (9 cm)
04S-105	4 1/2" (11 cm)
04S-106	5 1/2" (14 cm)

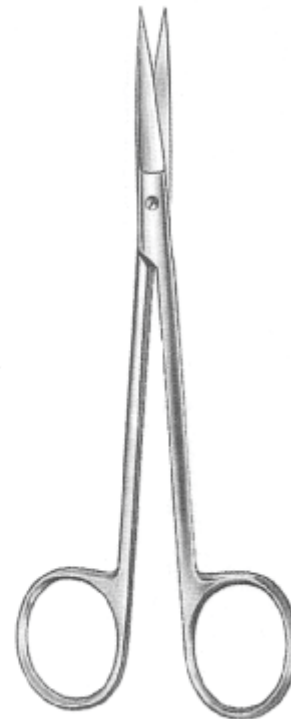

04S-107  
Joseph Scissors  
5 3/4" (14.5 cm)





# SCISSORS

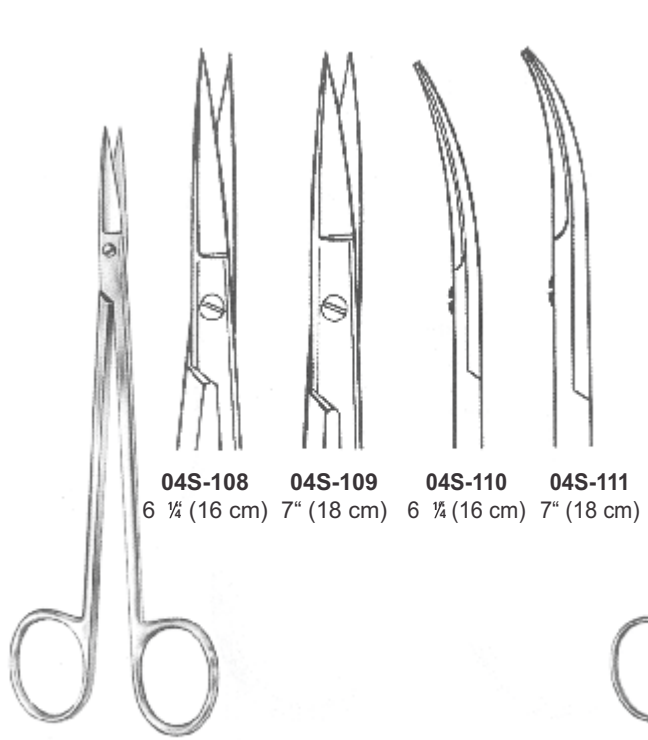

**04S-108** 6 1/4" (16 cm)  
**04S-109** 7" (18 cm)  
**04S-110** 6 1/4" (16 cm)  
**04S-111** 7" (18 cm)

Kelly Scissors

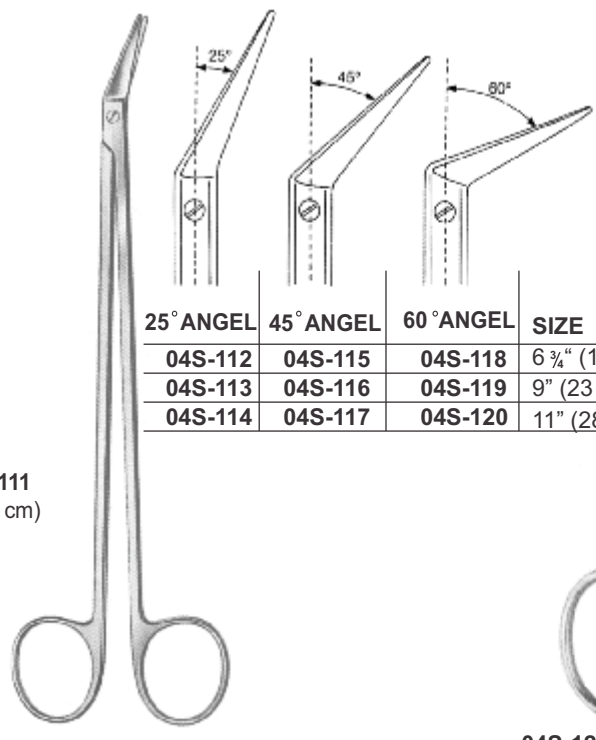

25° ANGEL	45° ANGEL	60° ANGEL	SIZE
<b>04S-112</b>	<b>04S-115</b>	<b>04S-118</b>	6 3/4" (17 cm)
<b>04S-113</b>	<b>04S-116</b>	<b>04S-119</b>	9" (23 cm)
<b>04S-114</b>	<b>04S-117</b>	<b>04S-120</b>	11" (28 cm)

De-Bakey Scissors

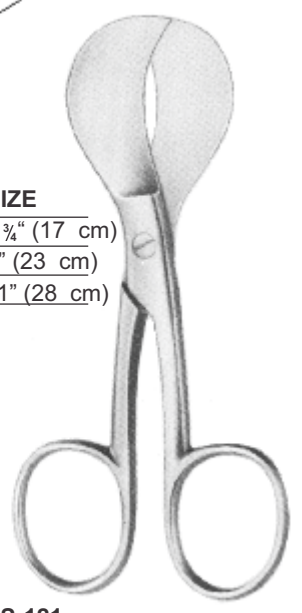

**04S-121**  
 US Umbilical Scissors 4 1/4" (10,5 cm)

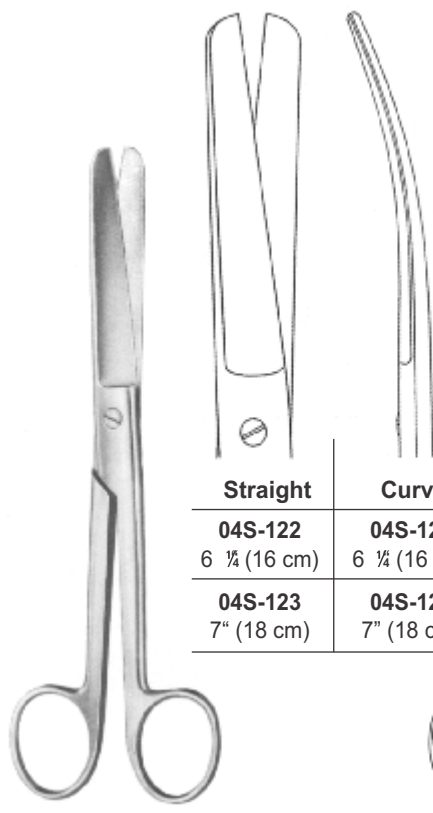

Straight	Curved
<b>04S-122</b> 6 1/4" (16 cm)	<b>04S-124</b> 6 1/4" (16 cm)
<b>04S-123</b> 7" (18 cm)	<b>04S-125</b> 7" (18 cm)

Doyen Abdominal Scissors

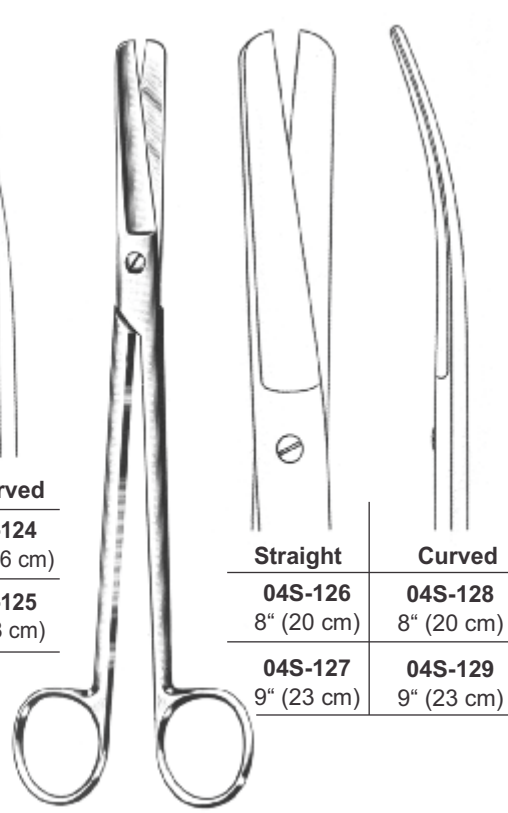

Straight	Curved
<b>04S-126</b> 8" (20 cm)	<b>04S-128</b> 8" (20 cm)
<b>04S-127</b> 9" (23 cm)	<b>04S-129</b> 9" (23 cm)

Parametrium Scissors

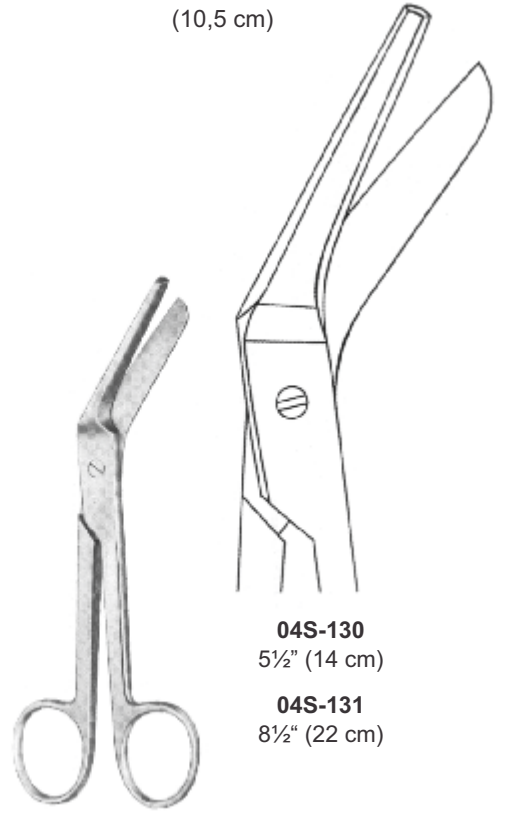

**04S-130**  
5 1/2" (14 cm)  
**04S-131**  
8 1/2" (22 cm)

Braun-Stadler Scissors

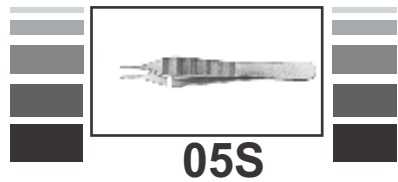

# DRESSING & TISSUE FORCEPS



SERRATED

1X2 TEETH

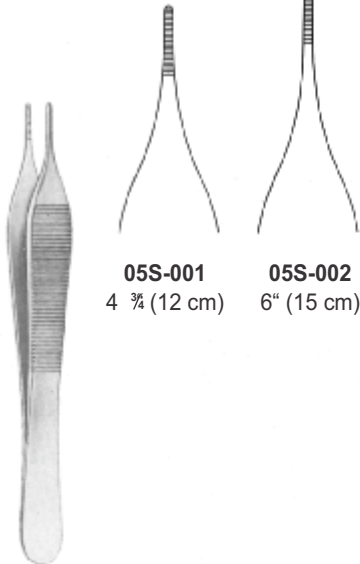

**05S-001**  
4 3/4" (12 cm)

**05S-002**  
6" (15 cm)



**05S-003**  
4 3/4" (12 cm)

**05S-004**  
6" (15 cm)



**05S-005**  
Adson-Brown Forceps  
4 3/4" (12 cm)

Adson Forceps



**05S-006** Adson  
Forceps Serrated  
4 3/4" (12 cm)

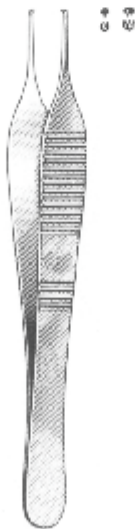

**05S-007** Adson  
Forceps  
1X2 TEETH  
4 3/4" (12 cm)

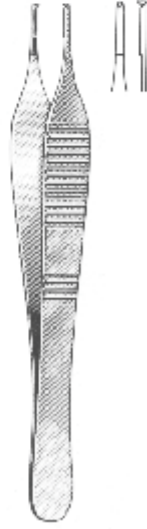

**05S-008**  
Adson Forceps  
1X2 TEETH  
WITH TYING  
PLATFORM  
4 3/4" (12 cm)



**05S-009**  
Adson Brown Forceps  
4 3/4" (12 cm)

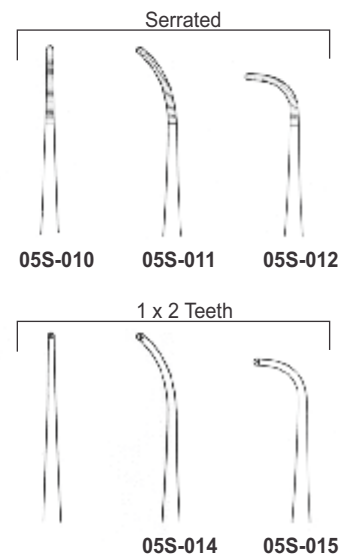

**05S-013**  
Splinter  
Forceps  
4 1/2" (11.5 cm)

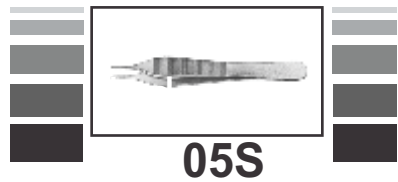

**05S**

# DRESSING & TISSUE FORCEPS



Dressing Forceps

<b>05S-016</b> 4½" (11.5 cm)	<b>05S-017</b> 5" (13 cm)	<b>05S-018</b> 5½" (14.5 cm)	<b>05S-019</b> 6 ¼" (16 cm)	<b>05S-020</b> 7" (18 cm)	<b>05S-021</b> 8" (20 cm)	<b>05S-022</b> 10" (25 cm)	<b>05S-023</b> 12" (30 cm)



Tissue Forceps

<b>05S-024</b> 4 ¼" (11 cm)	<b>05S-025</b> 4½" (11.5 cm)	<b>05S-026</b> 5" (13 cm)	<b>05S-027</b> 5½" (14.5 cm)	<b>05S-028</b> 6 ¼" (16 cm)	<b>05S-029</b> 7" (18 cm)	<b>05S-030</b> 8" (20 cm)	<b>05S-031</b> 10" (25 cm)	<b>05S-032</b> 12" (30 cm)

# DRESSING & TISSUE FORCEPS

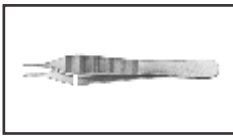

**05S**



**05S-033**  
6" (15 cm)

Mcindoe Forceps



**05S-034**  
6" (15 cm)

Gillies Dressing Forceps



Serrated

Semken Dressing &  
Tissue Forceps



Serrated

**05S-035**  
5" (12.5 cm)

**05S-037**  
5" (12.5 cm)



**05S-036**  
6" (155 cm)

**05S-038**  
6" (155 cm)

1 x 2 Teeth



Taylor Dressing &  
Tissue Forceps



**05S-039**  
7" (17 cm)

**05S-040**  
7" (17 cm)



Taylor Dressing &  
Tissue Forceps



**05S-041**  
7" (18.5 cm)



**05S-042**  
7" (18.5 cm)



Gerald Dressing &  
Tissue Forceps

Serrated



**05S-043**  
7" (18 cm)

1 x 2 Teeth



**05S-045**  
7" (18 cm)



**05S-044**  
7" (18 cm)



**05S-046**  
7" (18 cm)



Cushing Dressing &  
Tissue Forceps

Serrated



**05S-047**  
7" (17.5 cm)

1 x 2 Teeth

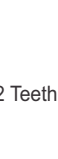

**05S-049**  
7" (17.5 cm)



**05S-048**  
7" (17.5 cm)



Potts-Smith Dressing &  
Tissue Forceps

Serrated



**05S-050**  
7" (18 cm)



**05S-053**  
7" (18 cm)



**05S-051**  
8 ¼ (21 cm)



**05S-054**  
8 ¼ (21 cm)



**05S-052**  
10" (25 cm)



**05S-055**  
10" (25 cm)

# DRESSING & TISSUE FORCEPS

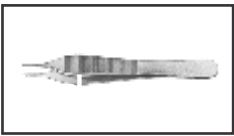

05S



Durante Tissue Forceps

**05S-056**  
5½" (14.5 cm)

**05S-057**  
6 ¼" (16 cm)

**05S-058**  
8" (20 cm)



Bonney Tissue Forceps

**05S-059**  
7" (18 cm)



Stone Tissue Forceps

**05S-060**  
6" (15 cm)



Lerche Tissue Forceps

**05S-061**  
6" (15 cm)



Mayo-Russ.  
Tissue Forceps

**05S-062**  
9" (23 cm)



Singley-Tuttle  
Tissue Forceps

**05S-063**  
9" (23 cm)



Russ. Modell  
Tissue Forceps

**05S-064**  
6" (15 cm)

**05S-065**  
8" (20 cm)

**05S-066**  
10" (25 cm)



Duval  
Tissue Forceps

**05S-067**  
5½" (14.5 cm)



Collin-Duval  
Grasping Forceps

**05S-068**  
8" (20 cm)



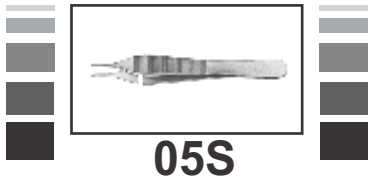

# DRESSING & TISSUE FORCEPS



**05S-069**  
Carhalt Splinter  
Forceps 4 1/4" (11 cm)



**05S-070**  
Carhalt Splinter  
Forceps 4 1/4" (11 cm)



**05S-071** 4 1/2" (11.5 cm)  
**05S-072** 4 1/2" (11.5 cm)



Walter Splinter Forceps



**05S-073**  
Feilchenfeld  
Splinter Forceps 3"  
(8 cm)



**05S-074**  
Splinter Forceps  
with Magnify  
Glass 3" (8 cm)



**05S-075**  
5" (12.5 cm)

Physicians Splinter Forceps



**05S-076**  
6" (15 cm)

Williams Splinter Forceps

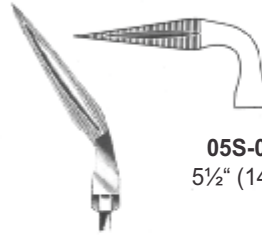

**05S-077**  
6" (15 cm)

**05S-078**  
5 1/2" (14 cm)

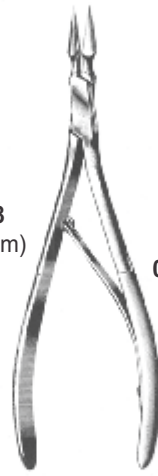

Virtus Splinter



**05S-079**  
5 1/2"

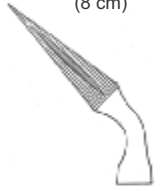

**05S-080**  
5 1/2"

## Swiss Jeweler Forceps

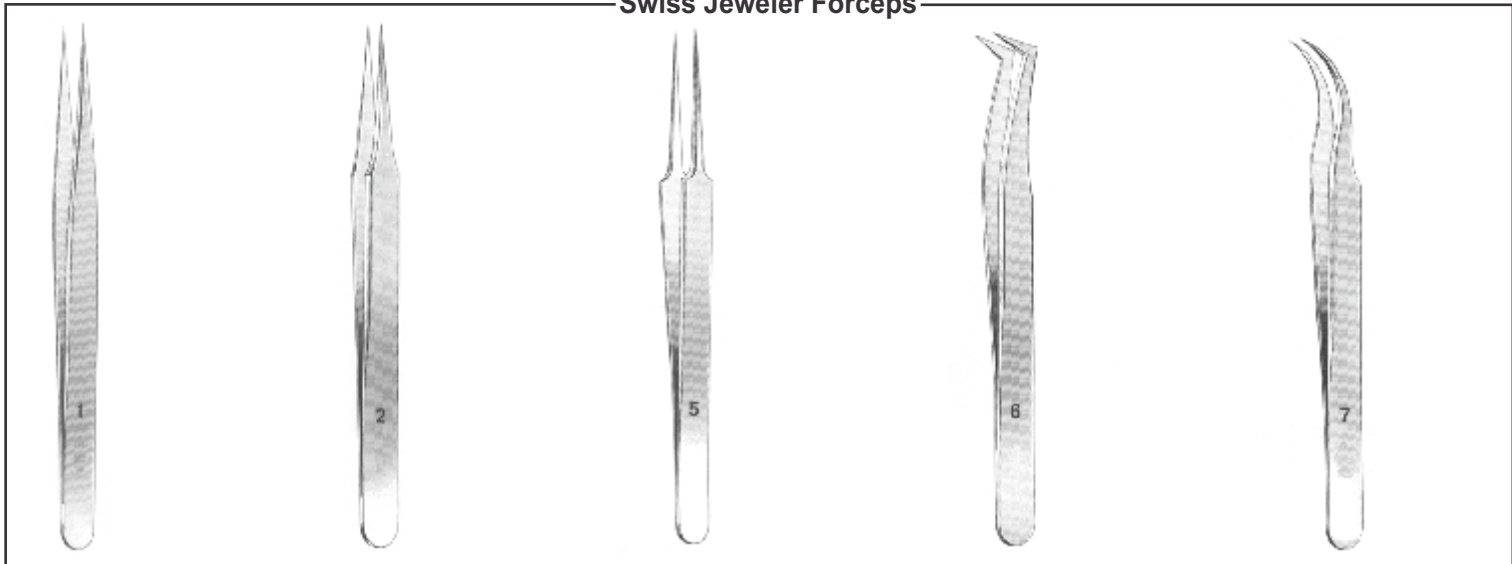

**05S-081**  
4 3/4" (12 cm)

**05S-082**  
4 3/4" (12 cm)

**05S-083**  
4 3/4" (12 cm)

**05S-084**  
4 3/4" (12 cm)

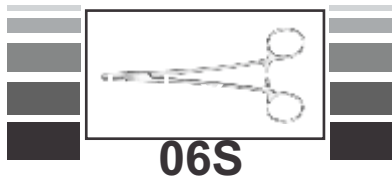

**05S-085**  
4 3/4" (12 cm)



# NEEDLE HOLDER



Derf Needle Holder

 **06S-001**  
 4 <sup>3</sup>/<sub>4</sub>" (12 cm)
  **06S-002**  
 5" (12.5 cm)



**06S-003**  
 Collier Needle  
 Holder 5" (12.5 cm)

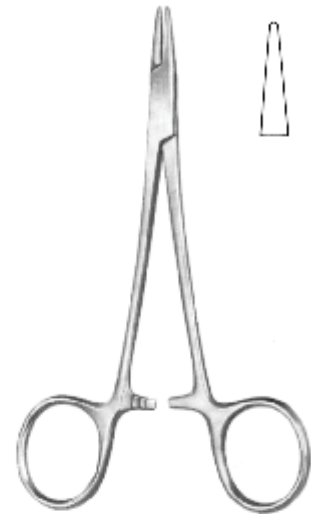

**06S-004**  
 Webster Needle  
 Holder 5" (13 cm)

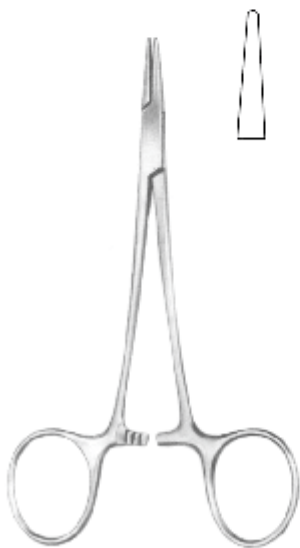

**06S-005**  
 Halsey Needle  
 Holder 5" (13 cm)



**06S-006**  
 Neivert Needle  
 Holder 5" (13 cm)



**06S-007**  
 Hegar-Baumgartner Needle  
 Holder 5 1/2" (14 cm)



Brown Needle Holder

ARTICLE #	SIZE
<b>06S-008</b>	5" (12.5 cm)
<b>06S-009</b>	7" 18 cm)

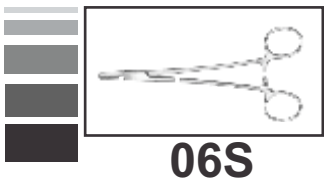

# NEEDLE HOLDER



				<p><b>06S-013</b> 5½" (14 cm)</p>	<p><b>06S-014</b> 6 ¼" (16 cm)</p>	<p><b>06S-015</b> 7" (18 cm)</p>	
<p><b>06S-010</b> Crile-Murray Needle Holder 6" (15 cm)</p>	<p><b>06S-011</b> Crile-Wood Needle Holder 6" (15 cm)</p>	<p><b>06S-012</b> Adson Needle Holder 7" (18 cm)</p>	<p>Mayo-Hagar Needle Holder</p>	<p><b>06S-016</b> 8" (20 cm)</p>	<p><b>06S-017</b> 9½" (24 cm)</p>	<p><b>06S-018</b> 10 ¼" (26 cm)</p>	
		<p><b>06S-021</b> 5½" (14 cm)</p>	<p><b>06S-022</b> 6½" (16 cm)</p>	<p><b>06S-023</b> 7¼" (18 cm)</p>	<p><b>06S-024</b> 5½" (14 cm)</p>	<p><b>06S-025</b> 6½" (16 cm)</p>	<p><b>06S-026</b> 7¼" (18 cm)</p>
<p><b>06S-020</b> Heaney Needle Holder 8¼" (21 cm)</p>	<p>Olsen-Hegar Needle Holder</p>	<p>Olsen-Hegar Needle Holder</p>	<p>Olsen-Hegar Needle Holder</p>	<p><b>06S-027</b> Gillies Needle Holder 6 ¼" (16 cm)</p>	<p><b>06S-027</b> Gillies Needle Holder 6 ¼" (16 cm)</p>	<p><b>06S-027</b> Gillies Needle Holder 6 ¼" (16 cm)</p>	

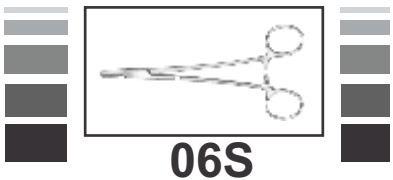

# NEEDLE HOLDER



**06S-028**  
Crile Needle Holder  
6" (15 cm)



Mathieu Needle Holder

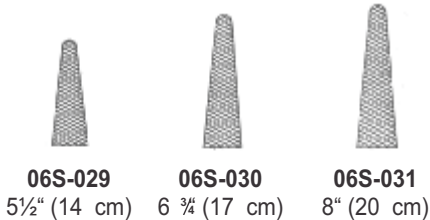

**06S-029** 5½" (14 cm)  
**06S-030** 6 ¾" (17 cm)  
**06S-031** 8" (20 cm)



Mathieu Needle Holder

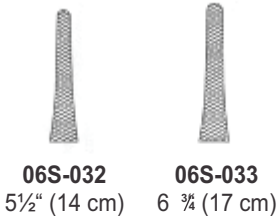

**06S-032** 5½" (14 cm)  
**06S-033** 6 ¾" (17 cm)



**06S-034**  
Toennis Needle Holder  
7" (18 cm)



**06S-035**  
Lichtenberg Needle Holder  
8" (20 cm)

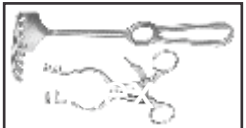
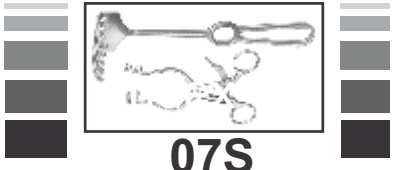

**07S**

# RETRACTORS

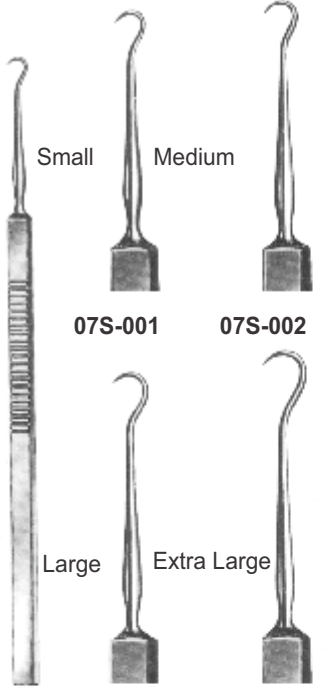

Small Medium

**07S-001** **07S-002**

Large Extra Large

**07S-003** **07S-004**

Graefe Hook  
6 1/4" (16 cm)

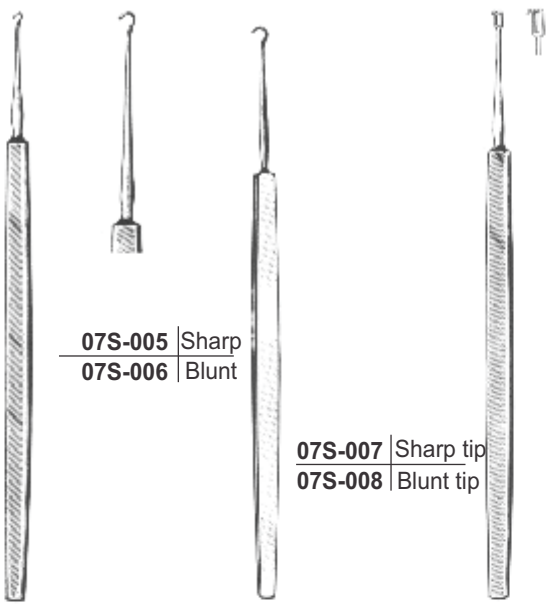

**07S-005** | Sharp  
**07S-006** | Blunt

**07S-007** | Sharp tip  
**07S-008** | Blunt tip

Tyreel Hook  
5" (12.5 cm)

Frazier Dura Hook  
5" (12.5 cm)

**07S-009**  
Guthrie Skin Hook  
5" (12.5 cm) 2 Prong



**07S-010** **07S-011**  
Wiener Skin Hook  
5" (12.5 cm), sharp    Wiener Skin Hook  
5" (12.5 cm), Blunt

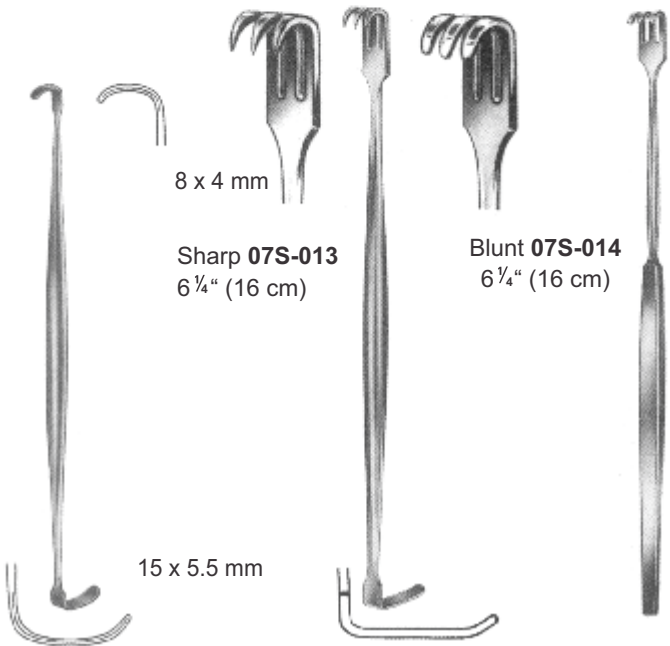

8 x 4 mm

Sharp **07S-013**  
6 1/4" (16 cm)

Blunt **07S-014**  
6 1/4" (16 cm)

15 x 5.5 mm

**07S-012**  
Ragnell Davis  
Retractor 5 1/2"  
(14 cm)

Senn-Mueller Retractor

Trachea Retractor  
6 1/4" (16 cm)

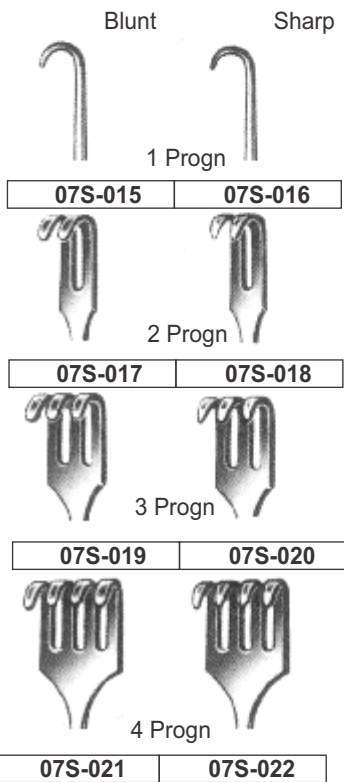

Blunt      Sharp

1 Progn

**07S-015**    **07S-016**

2 Progn

**07S-017**    **07S-018**

3 Progn

**07S-019**    **07S-020**

4 Progn

**07S-021**    **07S-022**

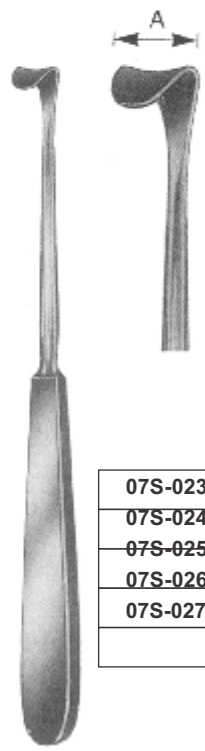

<b>07S-023</b>	A = 10mm
<b>07S-024</b>	A = 20mm
<b>07S-025</b>	A = 30mm
<b>07S-026</b>	A = 40mm
<b>07S-027</b>	A = 50mm

Morse Retractor  
9" (23 cm)

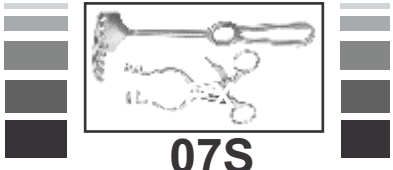

# RETRACTORS

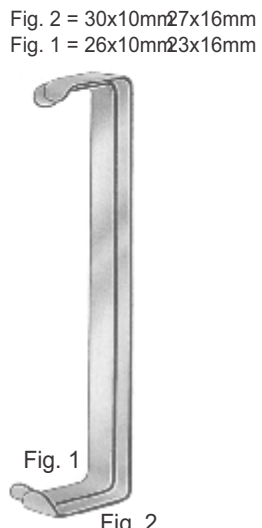
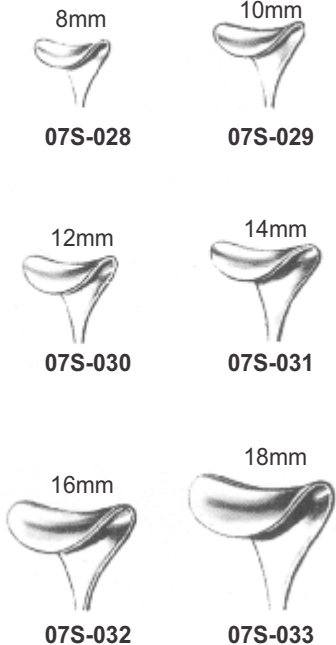
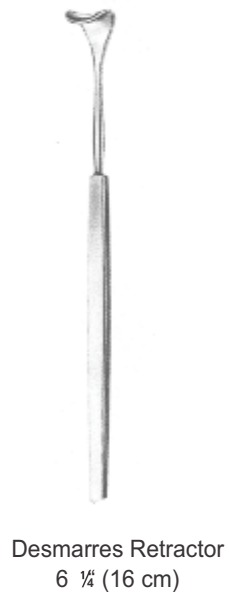
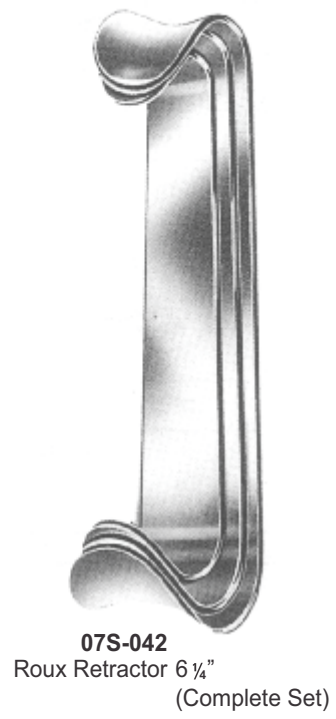
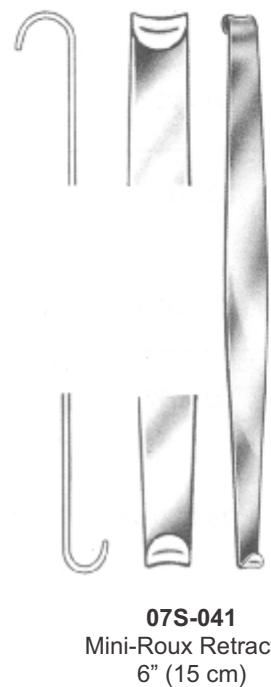
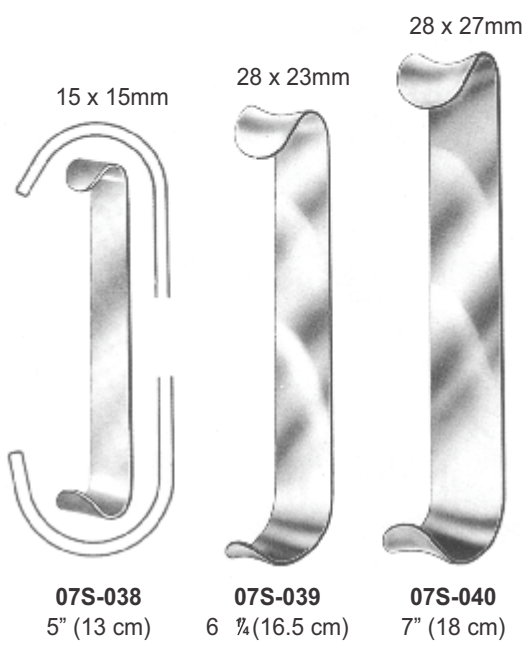

Fig. 2  
Fig. 1 = 36x28mm  
Fig. 2 = 71x43mm  
**07S-034**  
Richardson  
Eastman

Fig. 1 = 40x15mm  
Fig. 2 = 45x15mm  
**07S-035**  
US-Army (Parker-Langenbeck)  
8 1/4" (21 cm)

Fig. 1 = 30x13mm 26x16mm  
Fig. 2 = 34x13mm 30x16mm  
**07S-036** **07S-037**  
Farabeuf Farabeuf  
4 1/4" (12 cm) 6" (15 cm)





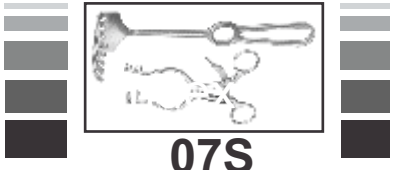

# RETRACTORS



## Deaver Retractor

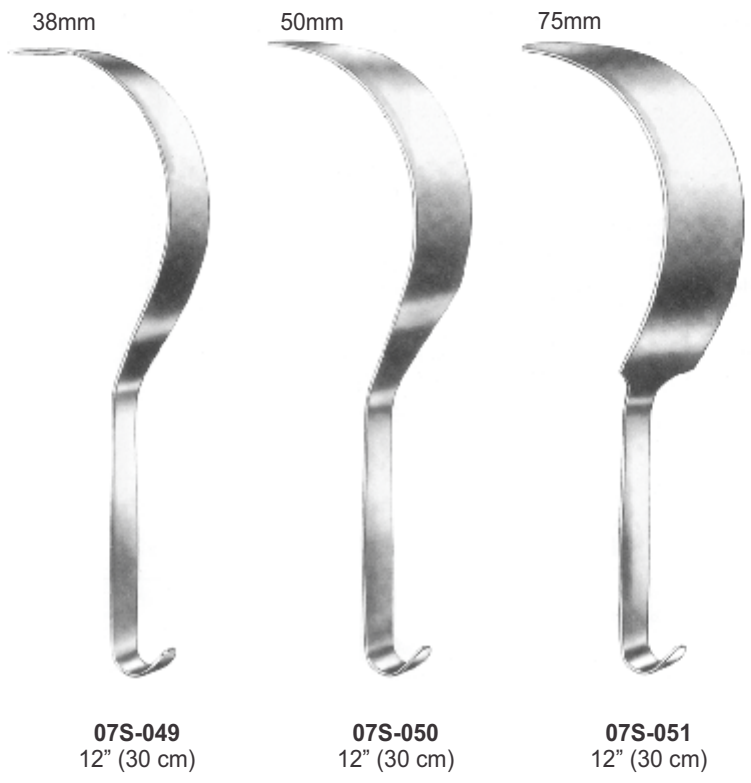

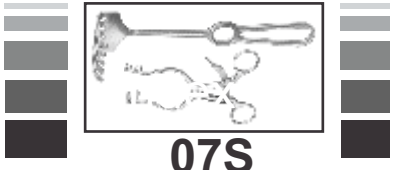

# RETRACTORS



Volkman Retractor

	9 x 8mm	9 x 13mm	9 x 19mm	9 x 29mm	9 x 40mm	
Sharp						
	07S-052	07S-053	07S-054	07S-055	07S-056	07S-057
						8½" (21.5 cm)
Blunt						
	07S-058	07S-059	07S-060	07S-061	07S-062	07S-063
						8½" (21.5 cm)
Semi-Blunt						
	07S-064	07S-065	07S-066	07S-067	07S-068	07S-069
						8½" (21.5 cm)



Mini Langenbeck Retractor  
6 ¼ (16 cm)

10 x 6mm		07S-070
20 x 6mm		07S-071
75 x 5mm		07S-072
28 x 8mm		07S-073

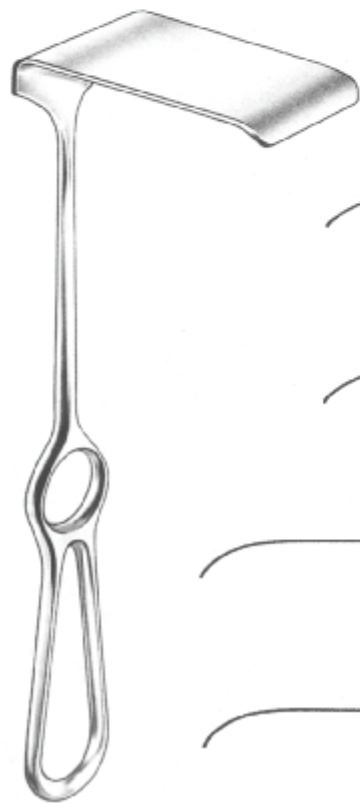

Kocher Retractor  
9" (23 cm)

	07S-074 40 x 18mm
	07S-075 60 x 20mm
	07S-076 60 x 25mm
	07S-077 75 x 30mm
	07S-078 75 x 40mm

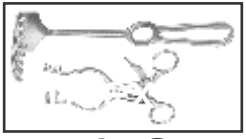
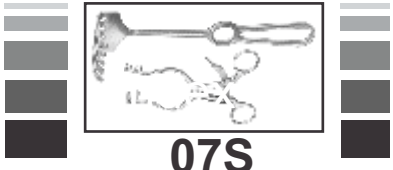

**07S**

# RETRACTORS



Kocher-Langenbeck Retractor  
8½" (21.5 cm)



**07S-083**  
35 x 15mm

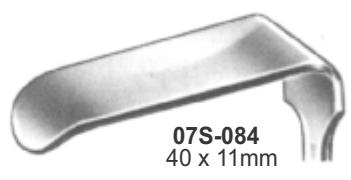

**07S-084**  
40 x 11mm



**07S-085**  
55 x 11mm



**07S-079**  
25 x 6mm



**07S-080**  
25 x 8mm



**07S-081**  
35 x 8mm



**07S-082**  
35 x 11mm



**07S-086**  
70 x 14mm

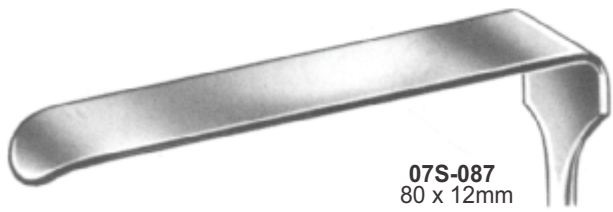

**07S-087**  
80 x 12mm

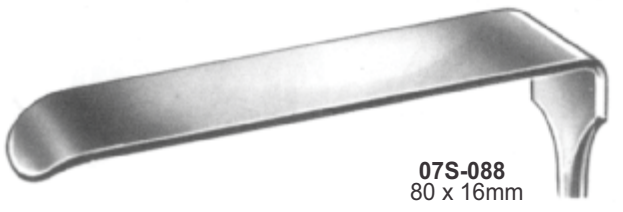

**07S-088**  
80 x 16mm

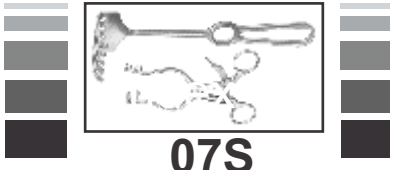

# RETRACTORS

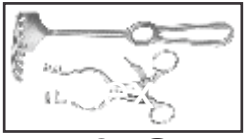

**07S**



Middeldorf Retractor

ARTICLE #	WIDE	SIZE
07S-089	14x17mm	8 1/4" (21.5 cm)
07S-090	20x22mm	8 3/4" (22.0 cm)
07S-091	26x30mm	9" (23.5 cm)

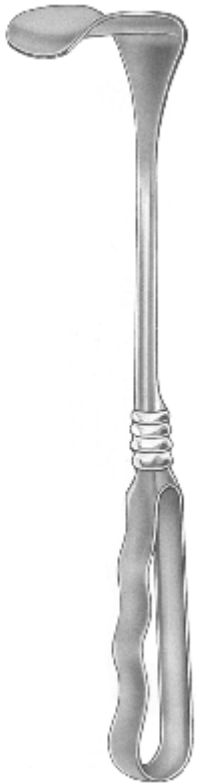

Richardson Retractor

ARTICLE #	WIDE	SIZE
07S-092	28x20mm	9" (24 cm)
07S-093	36x28mm	9" (24 cm)
07S-094	44x38mm	9" (24 cm)
07S-095	52x22mm	9" (24 cm)



**07S-096**

Kelly Retractor 65 x 50 mm 10" (26 cm)

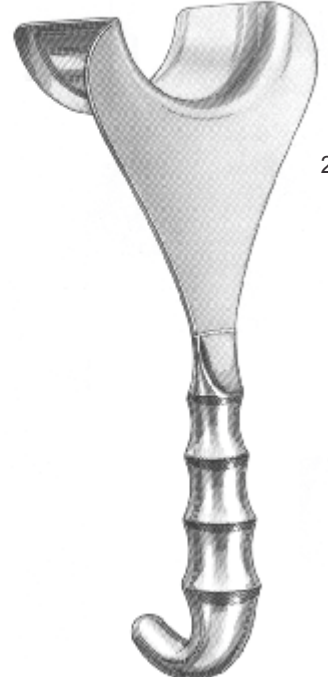

2 1/4" x 2"

**07S-097**

Delee Retractor



ARTICLE #	WIDE
07S-098	45x40mm
07S-099	45x50mm
07S-100	45x60mm
07S-101	45x75mm
07S-102	65x85mm

Fritsch Retractor  
9 1/2" (24 cm)



70 x 25mm

**07S-103**  
Kocher Retractor  
8 3/4" (22.5 cm)



80mm

ARTICLE #	WIDE
07S-104	80x42mm
07S-105	80x50mm
07S-106	80x60mm

Kocher Retractor  
9 3/4" (25 cm)

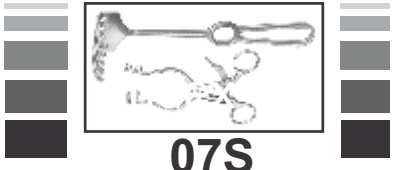

# RETRACTORS



07S



Gelpi Retractor

ARTICIE #	SIZE
07S-107	5" (13.5 cm)
07S-108	7" (17.5 cm)

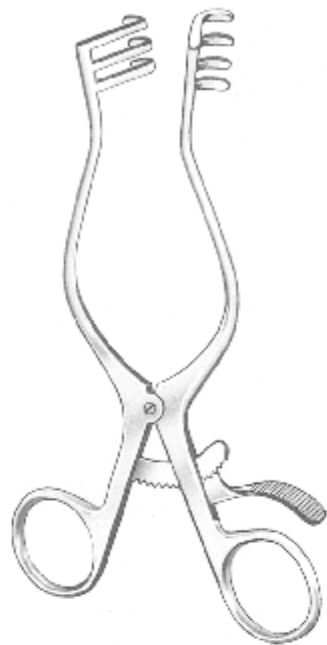

Weitlaner Retractor

Sharp	Blunt	Length	Prongs
07S-109	07S-114	4 1/4" (10 cm)	2 x 3
07S-110	07S-115	5" (13 cm)	3 x 4
07S-111	07S-116	6 1/4" (16 cm)	3 x 4
07S-112	07S-117	8" (20 cm)	3 x 4
07S-113	07S-118	9 3/4" (25 cm)	3 x 4

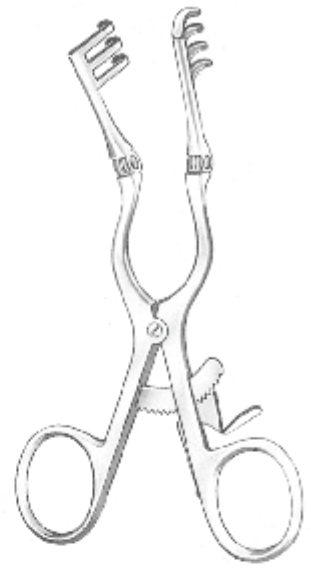

Cone Retractor

Sharp	Blunt	Length	Prongs
07S-119	07S-122	5" (13 cm)	3 x 4
07S-120	07S-123	6 1/2" (16 cm)	3 x 4
07S-121	07S-124	8" (20 cm)	3 x 4



Alm Retractor

Sharp	Blunt	Length
07S-125	07S-125	4" (10 cm)
07S-126	07S-126	2 3/4" (7 cm)



**07S-127**  
Markham-Meyerding  
Retractor  
7" (18 cm)



**07S-128**  
Miskimon Retractor  
7 1/2" (19 cm)

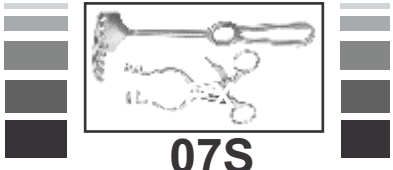

# RETRACTORS

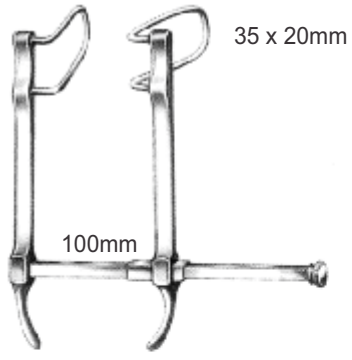

**07S-129**  
Gosset Retractor

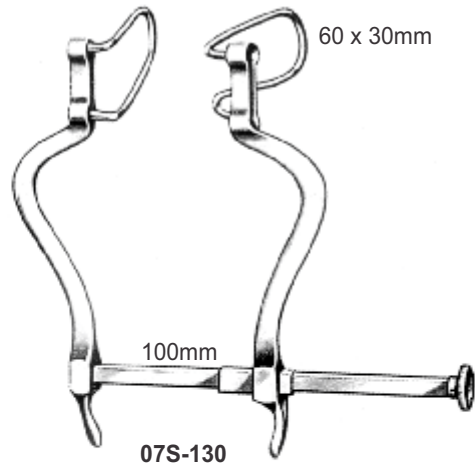

**07S-130**  
Gosset Retractor



**07S-131**  
Gosset Retractor

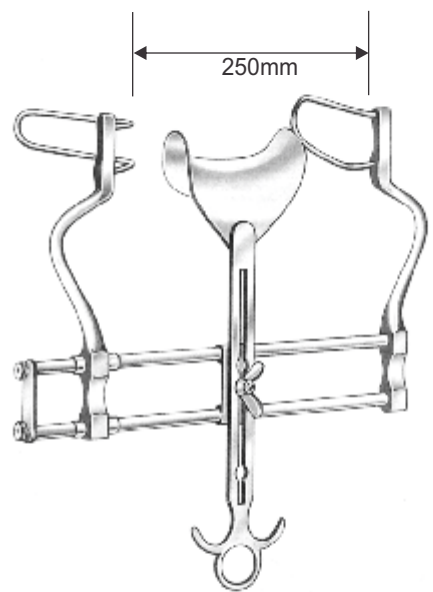

**07S-132**  
Balfour Retractor

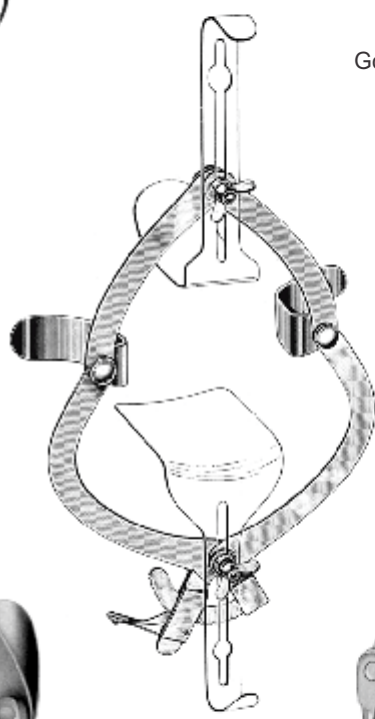

**07S-133**  
O'Sullivan-O'Connor  
Abdominal  
Retractor



**07S-134**  
Balfour Center Blade



**07S-135**  
Collin Abdominal  
Retractor 9" (23 cm)



Collin Retractor

ARTICLE #	SIDE BLADE	CENTER BLADE
<b>07S-136</b>	38 x 60mm	38 x 55mm
<b>07S-137</b>	38 x 80mm	50 x 75mm



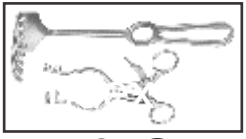
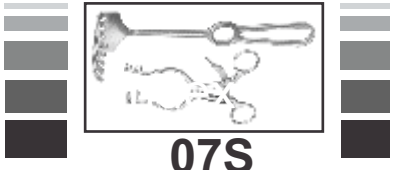

07S

# RETRACTORS

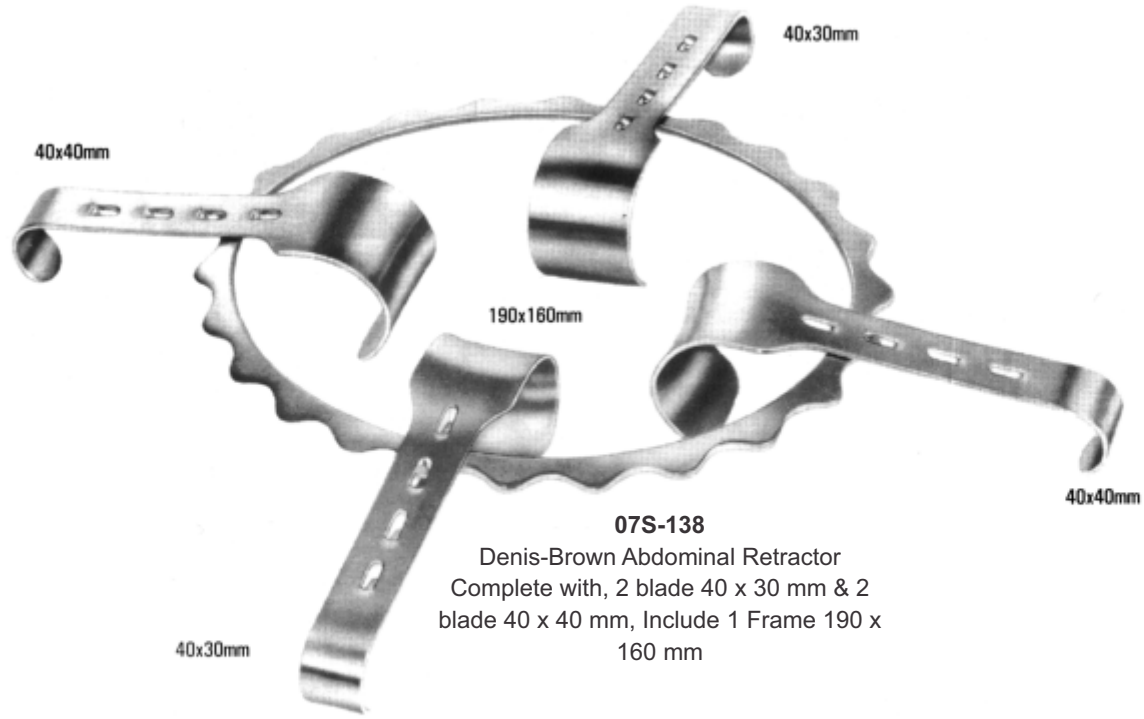

**07S-138**

Denis-Brown Abdominal Retractor  
Complete with, 2 blade 40 x 30 mm & 2  
blade 40 x 40 mm, Include 1 Frame 190 x  
160 mm

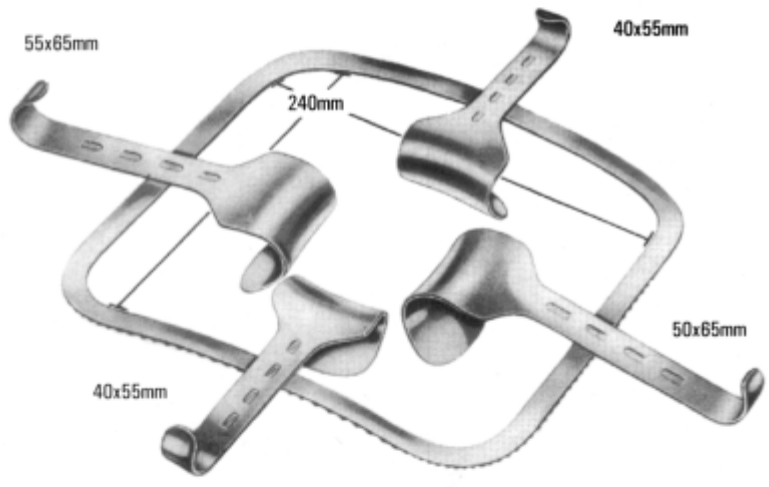

**07S-139**

Kirschner Abdominal Retractor  
Complete with, 2 blade 40 x 35 mm & 2  
blade 50 x 65 mm, Include 1 Frame Rigid,  
240 x 240 mm

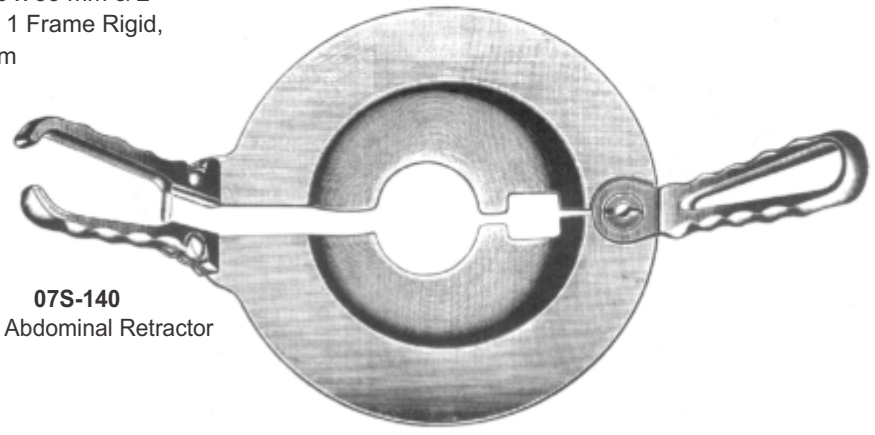

**07S-140**

Percy Abdominal Retractor

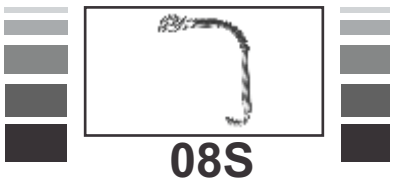

# ORAL INSTRUMENTS



08S



**08S-001**  
Tongue  
Depressors  
7½" (19 cm)

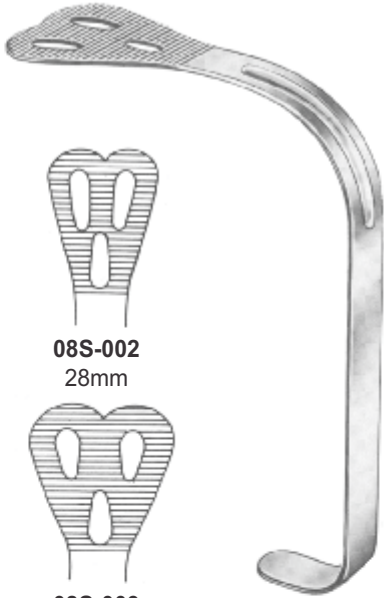

**08S-002**  
28mm

**08S-003**  
32mm

Wieder Tongue Depressors  
5½" (14 cm)



Magil Forceps

ARTICLE #	SIZE
<b>08S-004</b>	6" (16 cm)
<b>08S-005</b>	8" (20 cm)
<b>08S-006</b>	10" (25 cm)
<b>08S-007</b>	11" (28 cm)

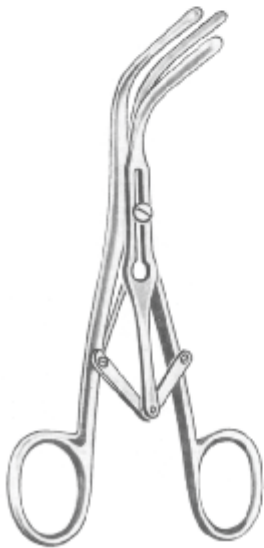

**08S-008**  
Trocars  
Laborde  
Dilators  
5½" (14 cm)



**08S-009**  
Trocars  
Dilatory  
Trousseau  
5½" (14 cm)



**08S-010**  
Tongue Holding  
Forceps Collin  
6 ¾" (16 cm)



**08S-012**  
Spare Rubber

**08S-011**  
Young Tongue  
Forceps 6 " (17 cm)

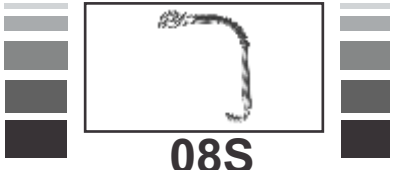

# ORAL INSTRUMENTS



**08S-013**  
Meister  
Mouth Gag 5"  
(13 cm)

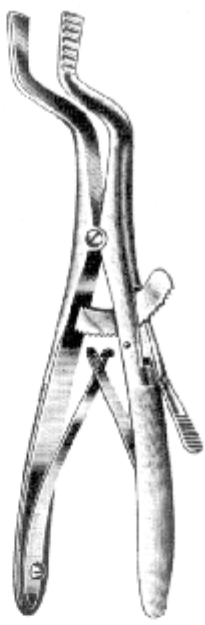

Roser-Konig Mouth Gag  
**ARTICLE #** | **SIZE**  
**08S-014** | 6¼" (16 cm)  
**08S-015** | 7½" (19 cm)

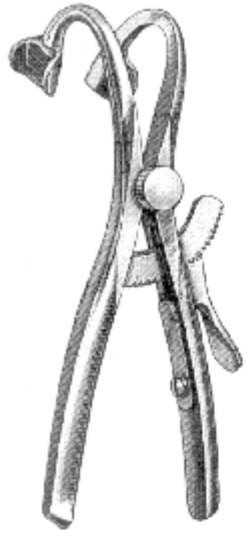

**08S-016**  
Denhardt  
Mouth Gag 6"  
(15 cm)

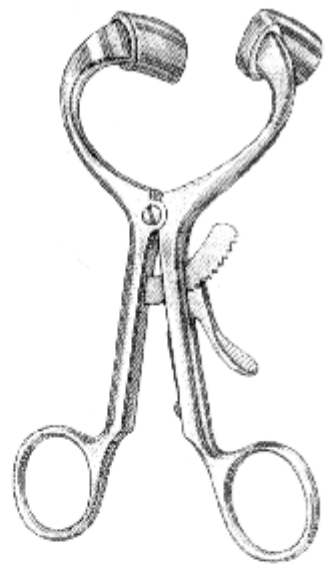

Molt Mouth Gag  
**ARTICLE #** | **SIZE**  
**08S-017** | 4" (10 cm)  
**08S-018** | 4½" (11,5 cm)  
**08S-019** | 5½" (14 cm)



Whitehead Mouth Gag  
**ARTICLE #** | **SIZE**  
**08S-020** | 3½" (9 cm)  
**08S-021** | 4¼" (11 cm)  
**08S-022** | 5" (13 cm)  
**08S-023** | 6" (15 cm)

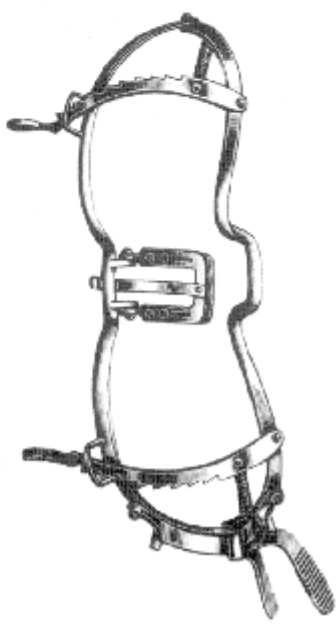

Whitehead Mouth Gag  
**ARTICLE #** | **SIZE**  
**08S-024** | 3½" (9 cm)  
**08S-025** | 4¼" (11 cm)  
**08S-026** | 5" (13 cm)  
**08S-027** | 6" (15 cm)



Jennings Mouth Gag  
**ARTICLE #** | **SIZE**  
**08S-028** | 3½" (9 cm)  
**08S-029** | 4¼" (11 cm)  
**08S-030** | 5" (13 cm)  
**08S-031** | 6" (15 cm)



Columbia Lip Retractor Double End  
**ARTICLE #** | **SIZE**  
**08S-032** | 4¼" (12 cm)  
**08S-033** | 5½" (14 cm)  
**08S-034** | 6¼" (16 cm)

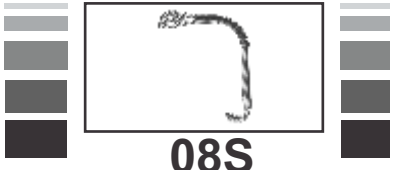

**08S**

# ORAL INSTRUMENTS

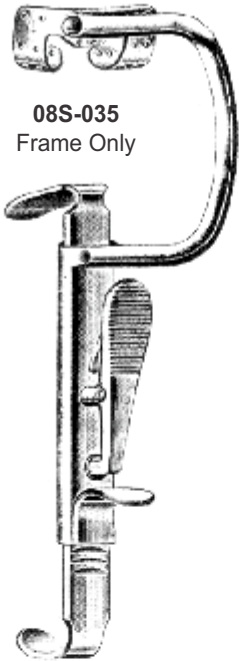

**08S-035**  
Frame Only

**08S-041**  
Negus  
Mouth Gag  
(Complete  
Set)

**08S-045**  
Frame Only

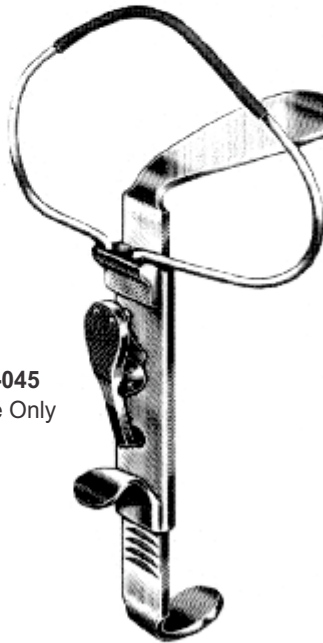

**08S-046**  
McIvor Mouth  
Gage  
(Complete  
Set)

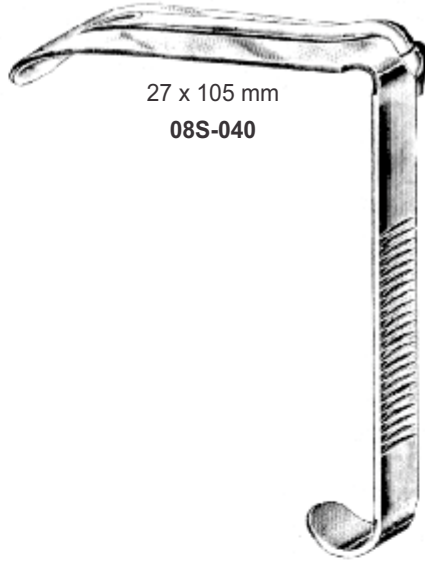

27 x 105 mm  
**08S-040**

Davis-Boyle Mouth Gags

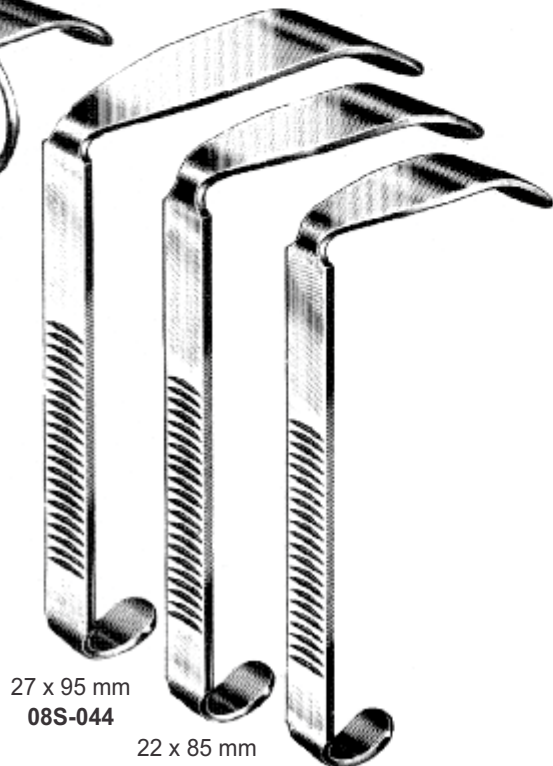

27 x 95 mm  
**08S-044**

22 x 85 mm  
**08S-043**

22 x 70 mm  
**08S-042**

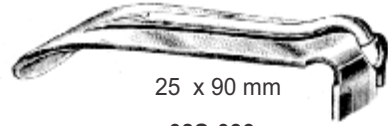

25 x 90 mm  
**08S-039**

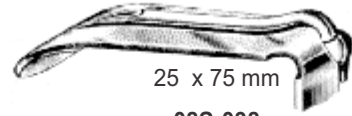

25 x 75 mm  
**08S-038**

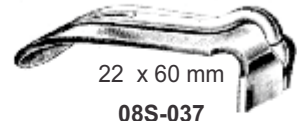

22 x 60 mm  
**08S-037**



20 x 15 mm  
**08S-036**

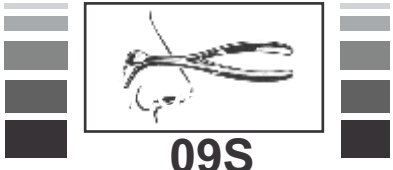

# E.N.T INSTRUMENTS



Hartmann-Halle Nasal Speculum  
5½" (14 cm)

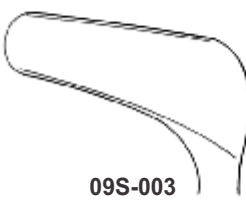
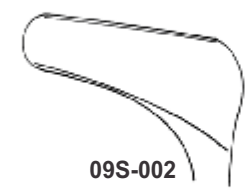
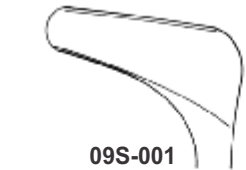

Hartmann Nasal Speculum  
5½" (14 cm)

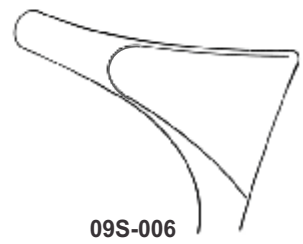
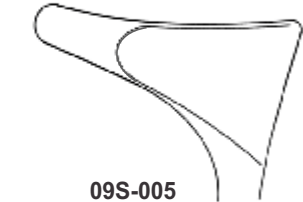
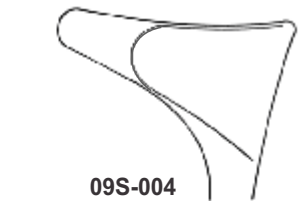

Tieck-Halle Nasal Speculum  
5 ¼ (13.5cm)



09S-009  
Beckmann Nasal Speculum 5" (13 cm)



Beckmann Nasal Speculum  
5½" (14 cm)

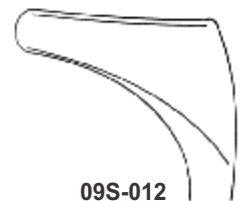
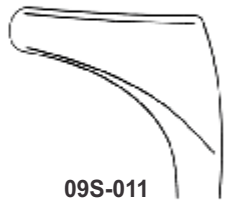
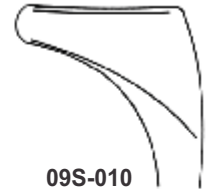



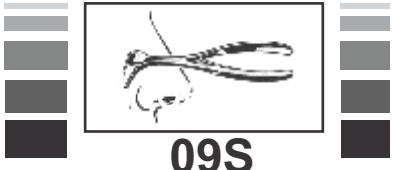

# E.N.T INSTRUMENTS



Killian Nasal Speculum  
5" (13 cm)

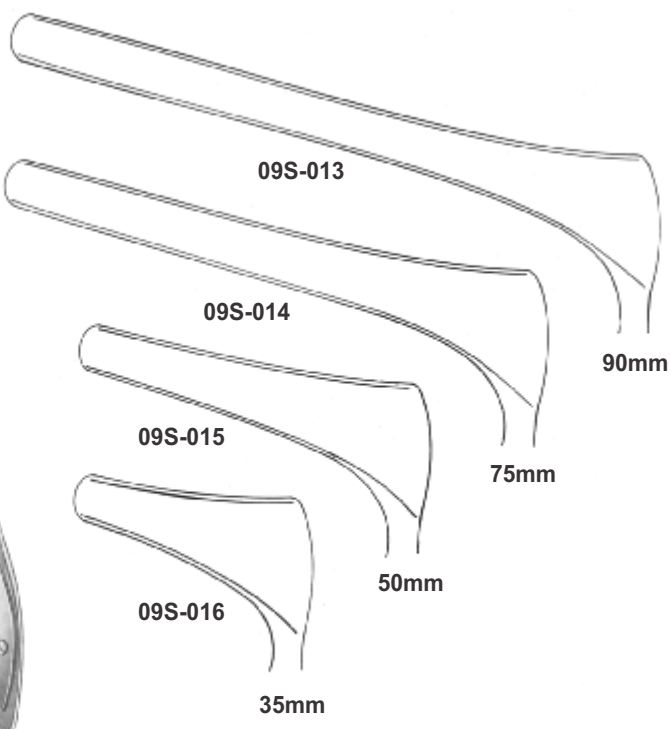

Vienna Nasal Speculum  
5½" (14 cm)

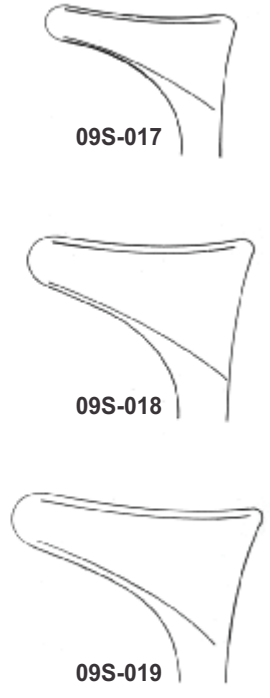

Thudichum  
(Goldsmith) Nasal  
Speculum 2½"  
(6.5cm)



Voltolini (Duplay) Nasal Speculum

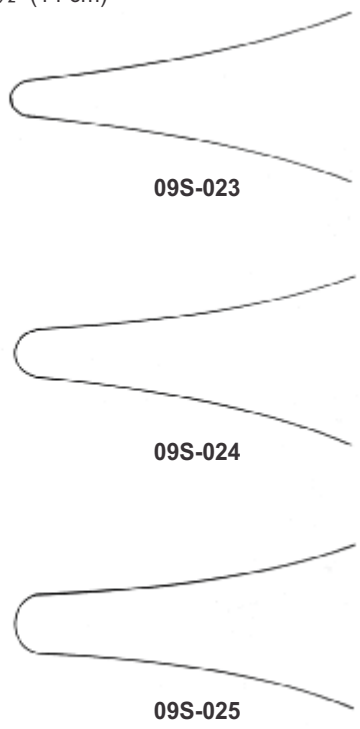



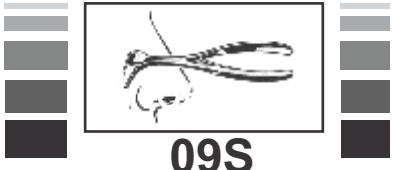

# E.N.T INSTRUMENTS



Politzer Ear Speculum

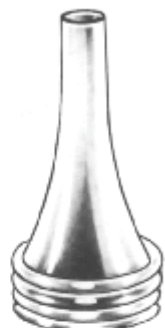

Toynbee Ear Speculum



Hartmann Ear Speculum



Gruber Ear Speculum

- 047
- 048
- 049
- 050

	Politzer Ear Speculum	Toynbee Ear Speculum	Hartmann Ear Speculum	Gruber Ear Speculum
2.0	<b>09S-026</b>	<b>09S-033</b>	<b>09S-040</b>	<b>09S-047</b>
3.0	<b>09S-027</b>	<b>09S-034</b>	<b>09S-041</b>	<b>09S-048</b>
3.5	<b>09S-028</b>	<b>09S-035</b>	<b>09S-042</b>	<b>09S-049</b>
4.0	<b>09S-029</b>	<b>09S-036</b>	<b>09S-043</b>	<b>09S-050</b>
5.0	<b>09S-030</b>	<b>09S-037</b>	<b>09S-044</b>	
6.5	<b>09S-031</b>	<b>09S-038</b>	<b>09S-045</b>	
7.5	<b>09S-032</b>	<b>09S-039</b>	<b>09S-046</b>	

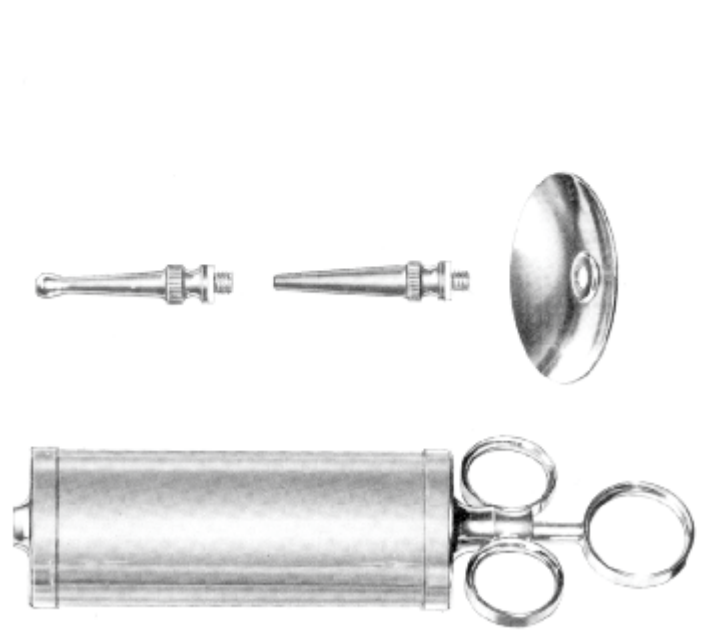

**09S-051**  
Ear Syringe (Complete Set)



**09S-052**  
Poltzer Air Bag (Complete Set with 4 Tips)

- 4 mm Ø
- 15 mm Ø
- 17 mm Ø
- 22 mm Ø

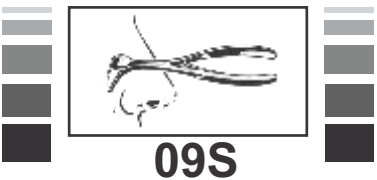

# E.N.T INSTRUMENTS

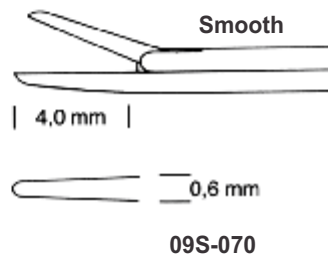
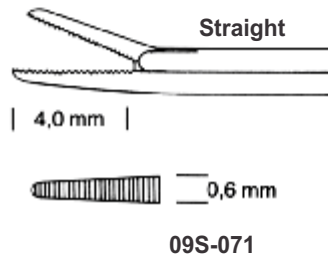
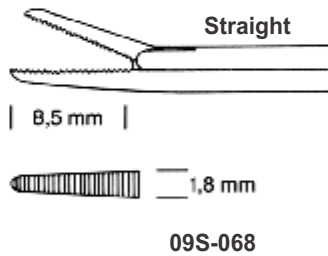
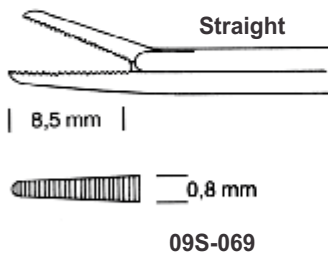
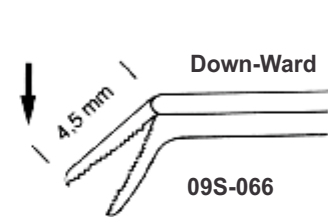
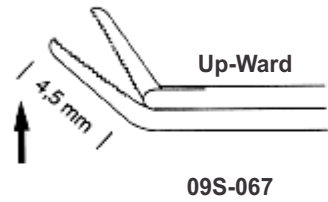
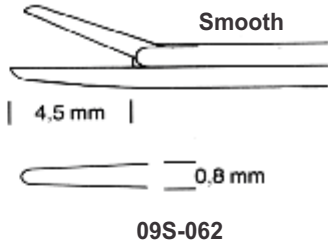
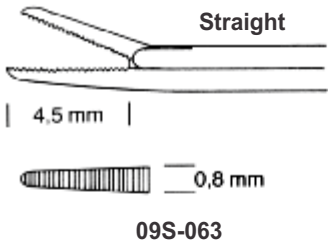

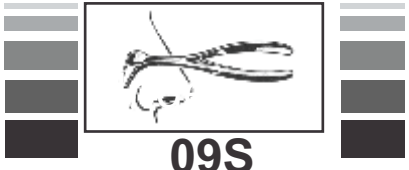

# E.N.T INSTRUMENTS



09S

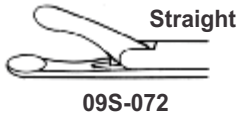

09S-072



09S-073



09S-075

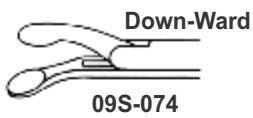

09S-074



09S-076

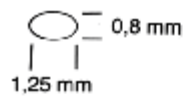

Micro Ear Forceps

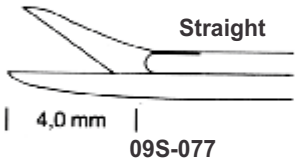

09S-077

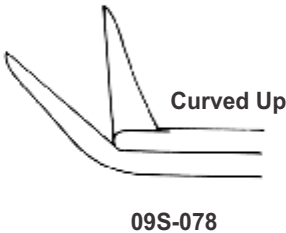

09S-078

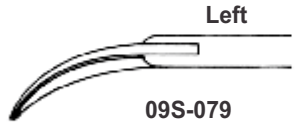

09S-079

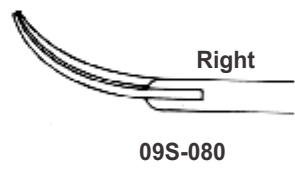

09S-080



Bellucci Micro Ear Forceps

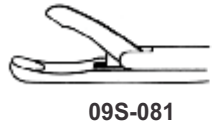

09S-081

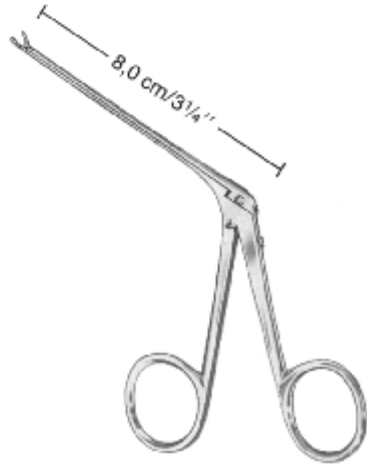

Crura-Nipper Micro Ear Forceps

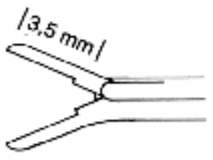

09S-082



McGEE Ear Forceps

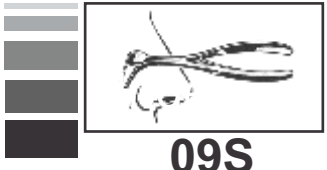

# E.N.T INSTRUMENTS



**09S-083**  
Hartmann-Wullstein



**09S-084**  
Hartmann-Wullstein



ARTICLE #	SHAFT
<b>09S-085</b>	3 1/2" (8.5cm)
<b>09S-086</b>	5 1/2" (14 cm)

Hartmann



ARTICLE #	SHAFT
<b>09S-088</b>	3 1/2" (8.5cm)
<b>09S-089</b>	5 1/2" (14 cm)

Hartmann



**09S-090**  
Hartmann-Noyes



**09S-091**  
Duckbill



**09S-092**  
Weingartner



ARTICLE #	CUP
<b>09S-093</b>	2.0mm
<b>09S-094</b>	2.5mm
<b>09S-095</b>	3.0mm

Hartmann



ARTICLE #	CUP
<b>09S-096</b>	2.0mm
<b>09S-097</b>	2.5mm
<b>09S-098</b>	3.0mm

Hartmann



**09S-099**  
Strompel



**09S-100**  
Hartmann



**09S-101**  
Hartmann



**09S-102**  
Hartmann-Hoffmann

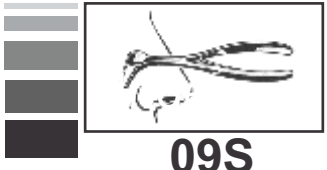

# E.N.T INSTRUMENTS



09S



**09S-103**  
Hartmann  
4 3/4" (12 cm)

**09S-104**  
Hartmann  
5 1/2" (14 cm)

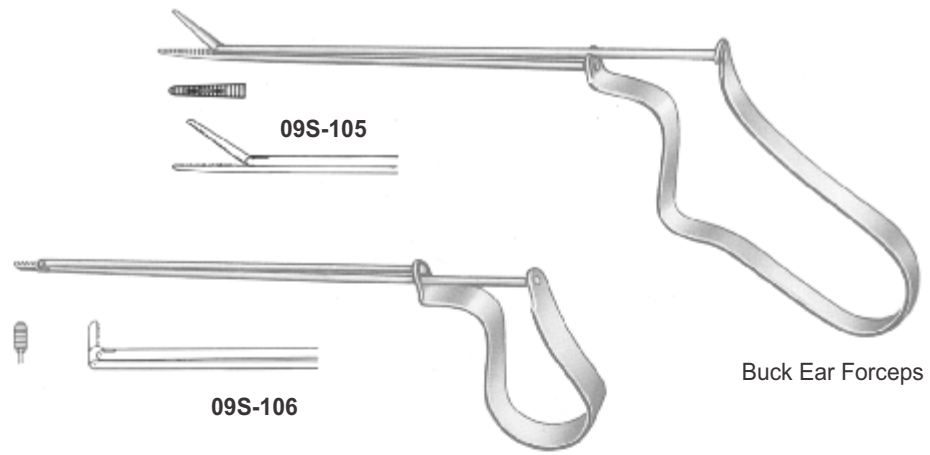

Buck Ear Forceps

Quire Ear Forceps



ARTICLE #	SIZE
09S-107	6 1/4" (16 cm)
09S-108	8" (20 cm)

Hartmann



**09S-109**  
Heymann-Knight Nasal  
Polypus Forceps 7" (18 cm)



**09S-110**  
Lubet-Barbon  
8" (20 cm)



**09S-111** Killian  
6 3/4" (17 cm)



Westmacott  
8" (20 cm)



09S-112



09S-113



**09S-114**  
Hartmann Nasal  
Polypus Forceps 7 1/2"  
(19 cm)



# E.N.T INSTRUMENTS

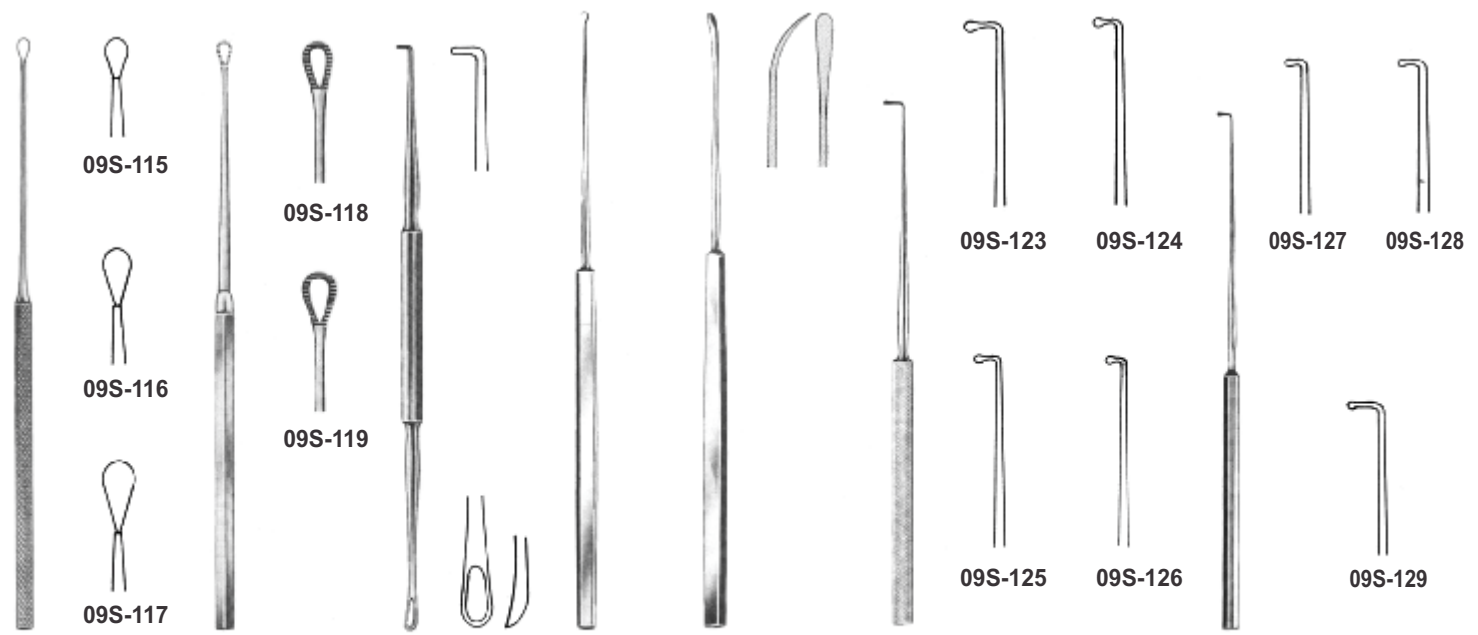

**09S-115**  
**09S-116**  
**09S-117**  
**09S-118**  
**09S-119**  
**09S-120** Gross  
**09S-121** Hartmann  
**09S-122** Zaufal  
**09S-123**  
**09S-124**  
**09S-125**  
**09S-126**  
**09S-127**  
**09S-128**  
**09S-129**

Billeau 6½" (16.5cm)  
 Snellen 6½" (16.5cm)  
 4 ¾" (12 cm)  
 6½" (16.5cm) 6½" (16.5cm)  
 Wagener 5½" (14 cm)  
 Lucae 5½" (14 cm)

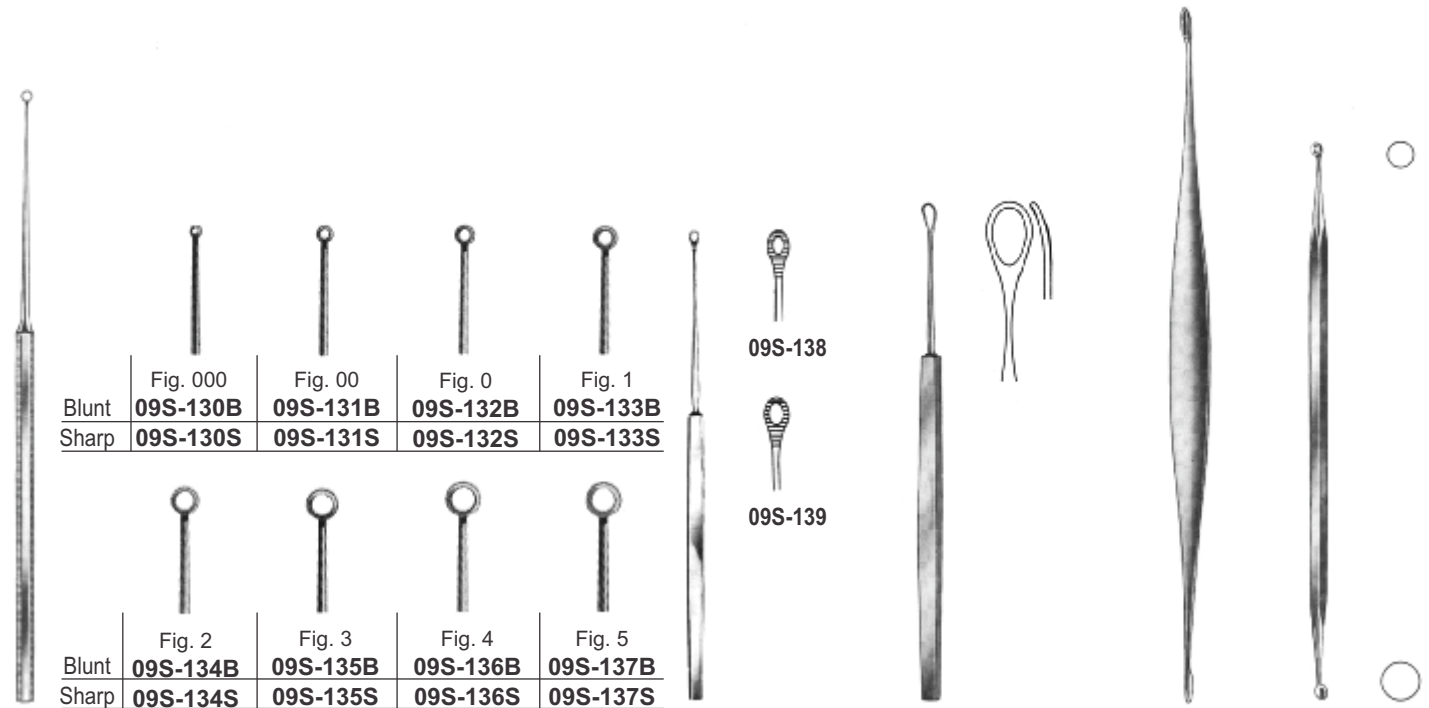

**09S-130B** Fig. 000 Blunt  
**09S-130S** Fig. 000 Sharp  
**09S-131B** Fig. 00 Blunt  
**09S-131S** Fig. 00 Sharp  
**09S-132B** Fig. 0 Blunt  
**09S-132S** Fig. 0 Sharp  
**09S-133B** Fig. 1 Blunt  
**09S-133S** Fig. 1 Sharp  
**09S-134B** Fig. 2 Blunt  
**09S-134S** Fig. 2 Sharp  
**09S-135B** Fig. 3 Blunt  
**09S-135S** Fig. 3 Sharp  
**09S-136B** Fig. 4 Blunt  
**09S-136S** Fig. 4 Sharp  
**09S-137B** Fig. 5 Blunt  
**09S-137S** Fig. 5 Sharp  
**09S-138**  
**09S-139**  
**09S-140** Langenbeck  
**09S-141** Barth  
**09S-142** Jansen

Buck 6½" (16.5cm)  
 Shapleigh 5¼" (13 cm)  
 5¼" (13 cm)  
 7" (18 cm)  
 6" (15 cm)



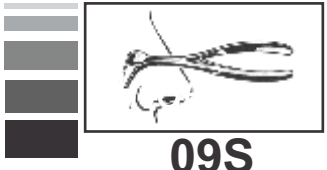

**09S**

# E.N.T INSTRUMENTS



09S-143    09S-144

09S-145    09S-146

09S-147    3.5mm

09S-148    4.0mm

09S-149    4.5mm

09S-150    5.0mm

09S-151

09S-152

09S-153    09S-154    09S-155

09S-156    09S-157    09S-158

Fisch  
6 ¼ (16 cm)

House  
6 ¼ (16 cm)

Rosen  
7½" (19 cm)

Rosen  
6 ¼ (16 cm)

09S-159  
Plester  
6 ¼ (16 cm)

09S-160    1.0mm

09S-161    1.4mm

09S-162    1.6mm

09S-163    2.0mm

09S-163    2.6mm

09S-164    2.8mm

09S-165    3.0mm

09S-167    Plester

09S-168    Tabb

09S-169    Plester

09S-170    Tabb

09S-171

09S-172

09S-173  
Wullstein  
6 ¼ (16 cm)

09S-174  
Schuknecht  
6 ¼ (16 cm)

Rosen  
6 ¼ (16 cm)





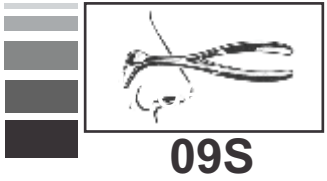



















6¼" (16 cm)

Schuknecht  
6 ¼ (16 cm)



# E.N.T INSTRUMENTS



 <p><b>09S-175</b> House Foot Plate Hand Instruments 6" (15 cm)</p>	 <p><b>09S-176</b> House Foot Plate Hand Instruments 6" (15 cm)</p>	 <p><b>09S-179</b> Shea Foot Plate Hand Instruments 6 1/4" (16 cm)</p>	 <p><b>09S-180</b> Shea Foot Plate Hand Instruments 6 1/4" (16 cm)</p>	 <p><b>09S-185</b> Buckingham Foot Plate Hand Instruments 6 1/4" (16 cm)</p>	 <p><b>09S-181</b> Buckingham</p>  <p><b>09S-183</b> Buckingham</p>  <p><b>09S-185</b> Buckingham</p>	 <p><b>09S-182</b> Larkin</p>  <p><b>09S-184</b> Larkin</p>  <p><b>09S-186</b> Larkin</p>
 <p><b>09S-187</b> Fig.0</p>  <p><b>09S-188</b> Fig.00</p>  <p><b>09S-189</b> Fig.000</p>  <p><b>09S-190</b> Fig.0000</p>  <p><b>09S-191</b> Fig.00000</p> <p>Lempert Curettes 8 1/4 (21 cm)</p>	 <p><b>09S-192</b> 2.2mm</p>  <p><b>09S-193</b> 3.2mm</p> <p>Wullstein Curettes 6 1/4 (16 cm)</p>	 <p><b>09S-194</b> Lempert Curettes 6 1/4" (16 cm)</p>	 <p><b>09S-195</b> Shambaugh- Derlacki Curettes 6 1/4" (16 cm)</p>	 <p><b>09S-196</b> 2mm</p>  <p><b>09S-198</b> 4mm</p> <p>Lempert Curettes 6 3/4 (17 cm)</p>	 <p><b>09S-197</b> 3mm</p>  <p><b>09S-199</b> 5mm</p>	 <p>3mm</p>

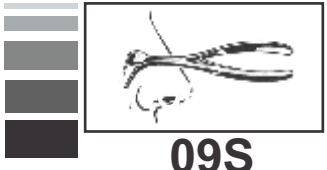

09S

# E.N.T INSTRUMENTS



	3 mm	4 mm	5 mm
Straight	09S-200	09S-201	09S-202
Curved	09S-203	09S-204	09S-205

Straight

Curved

Ballenger Spetum Knives  
8"(20 cm)

09S-206  
Joseph-Masing  
8 3/4"(22 cm)

09S-207  
Halle  
Periosteal  
Elevators  
6 1/2"(16.5cm)

09S-208  
Joseph  
Periosteal  
Elevators  
6 1/2"(16.5cm)

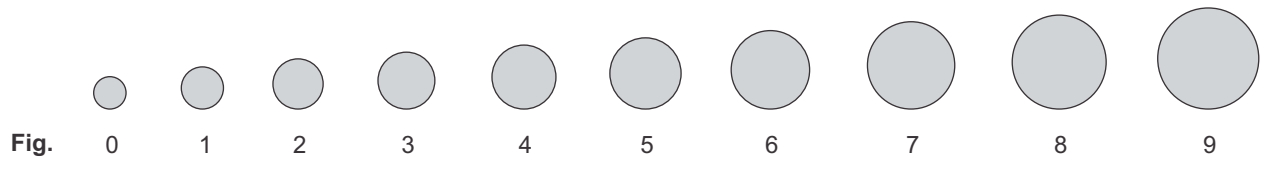

ARTICLE #	Fig.	mm O/
09S-209	4	0
09S-210	1	5
09S-211	2	6
09S-212	3	7
09S-213	4	8
09S-214	5	9
09S-215	6	10
09S-216	7	11
09S-217	8	12
09S-218	9	13

Luer

ARTICLE #	Fig.	mm O/
09S-219	4	0
09S-220	1	5
09S-221	2	6
09S-222	3	7
09S-223	4	8
09S-224	5	9
09S-225	6	10
09S-226	7	11
09S-227	8	12
09S-228	9	13

Chevalier-Jackson

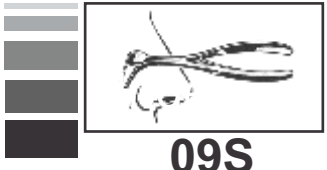

**09S**

# E.N.T INSTRUMENTS



**09S-239**  
Krause Nasal  
Snare 6 1/4"  
(16 cm)



**09S-240**  
Krause-Voss  
Nasal Snare 6 1/4"  
(16 cm)



**09S-241**  
Lange-Wilde  
Nasal Snare 6 1/4"  
(16 cm)

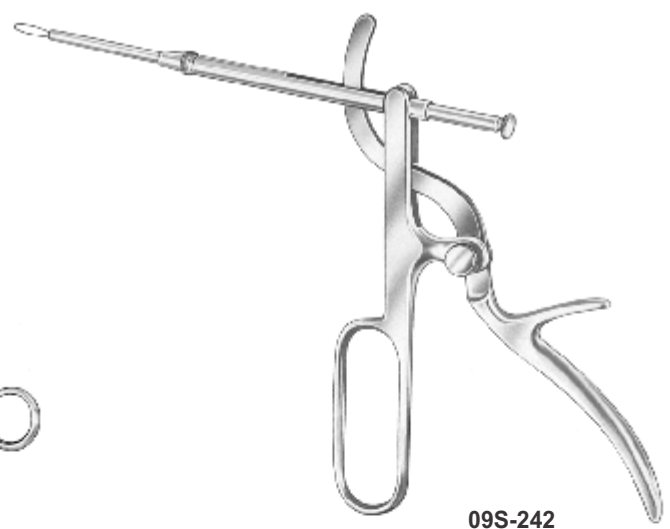

**09S-242**  
Tonsil Snare



Hartmann  
Otology  
Instruments  
5 1/2" (14 cm)

- 09S-243**
- 09S-244**
- 09S-245**
- 09S-246**
- 09S-247**
- 09S-248**



**09S-249 - 09S-255**  
Frazier Suction  
Tubes 7 1/2" (19 cm)

ARTICLE #	Fr.
09S-249	6
09S-250	7
09S-251	8
09S-252	9
09S-253	10
09S-254	11
09S-255	12



**09S-256 - 09S-258**  
Baron Suction Tubes

ARTICLE #	Fr.
09S-256	3
09S-257	5
09S-258	7



**09S-259**  
Suction  
Tubes 11 1/4"  
(30 cm)

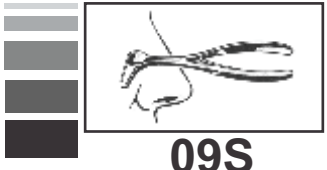

09S

# E.N.T INSTRUMENTS

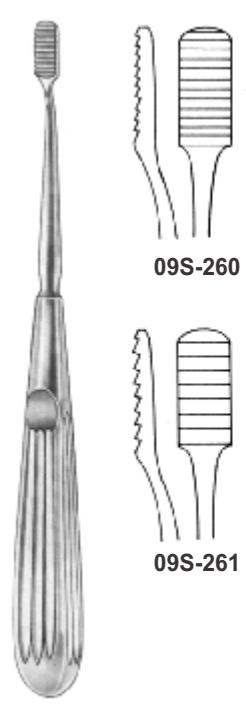

Lewis  
7" (18 cm)

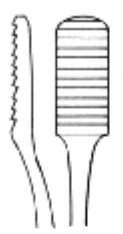

09S-260

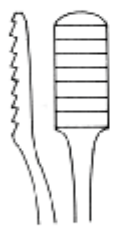

09S-261

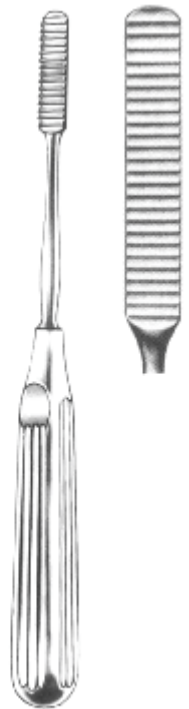

09S-262  
Cottle  
8 1/4" (21 cm)

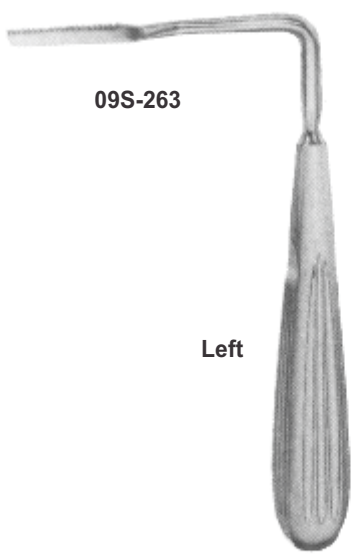

09S-263

Left

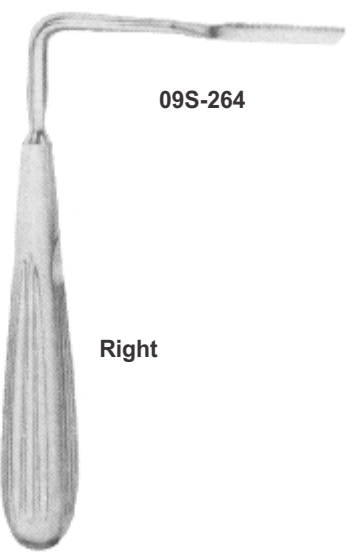

09S-264

Right

Joseph  
6 3/4" (17 cm)



09S-265  
Maltz  
7" (18 cm)

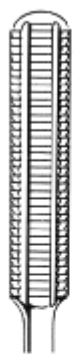

Joseph  
7 1/2" (19 cm)



09S-266

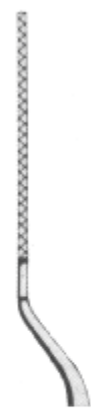

09S-267



09S-268



Aufricht  
8 1/4" (21 cm)



09S-269



09S-270

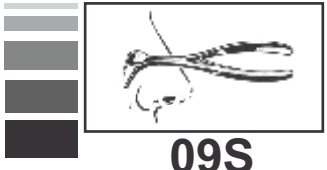

# E.N.T INSTRUMENTS



**09S-271-  
09S-276**  
Hartmann  
Tuning Fork

<b>09S-271</b>	C 128
<b>09S-272</b>	C 256
<b>09S-273</b>	C 512
<b>09S-274</b>	C 1024
<b>09S-275</b>	C 2048
<b>09S-276</b>	C 4096



**09S-277-  
09S-282**  
Lucae  
Tuning Fork

<b>09S-277</b>	C 128
<b>09S-278</b>	C 256
<b>09S-279</b>	C 512
<b>09S-280</b>	C 1024
<b>09S-281</b>	C 2048
<b>09S-282</b>	C 4096

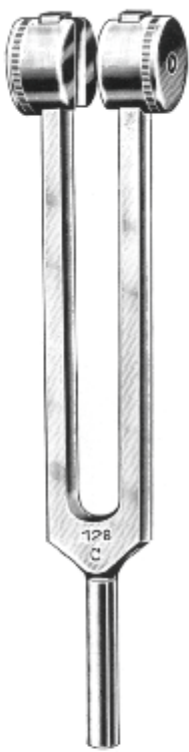

**09S-283- 09S-285**  
Tuning Fork

<b>09S-283</b>	C 64
<b>09S-284</b>	C 128
<b>09S-285</b>	C 256

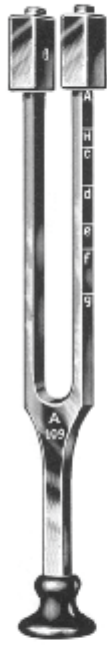

**09S-286**  
Koenig  
A-109  
Tuning  
Fork

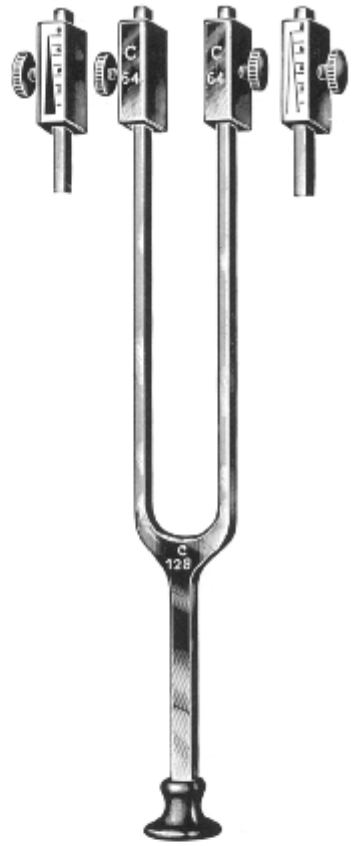

**09S-287**  
Rydell-  
Seiffer  
C64/C128  
8 Tuning  
Fork

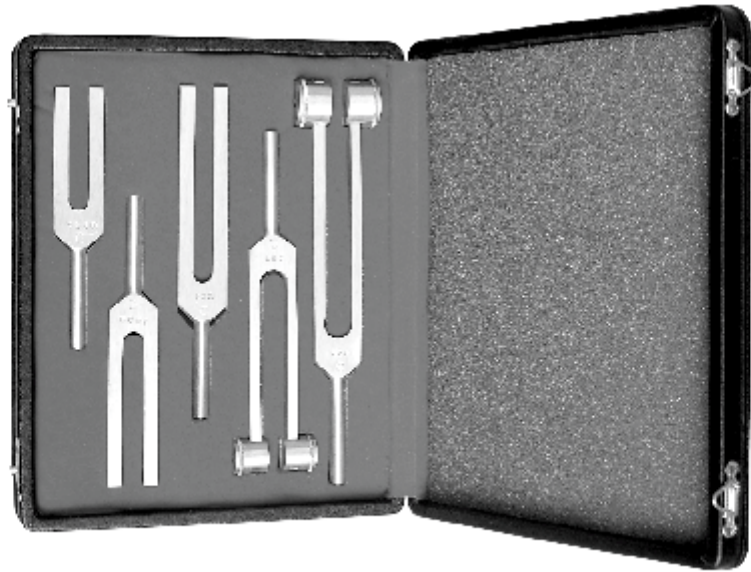

**09S-288**  
Set of Tuning  
Forks C 128  
C 256  
C 512  
C 1024  
C 2048



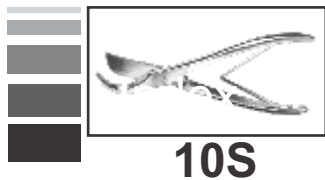

**10S**

# NEURO SURGERY INSTRUMENTS



**10S-001**  
Bone & Rib  
Shears 9" (23  
cm)



**10S-002**  
Bone & Rib  
Shears 8 "  
(22 cm)



**10S-003**  
Gluck  
Bone & Rib  
Shears 8 "  
(22 cm)



**10S-004**  
Brunner Sternum  
Scissors 12½" (32 cm)



**10S-005**  
Giertz-Stille  
Sternum  
Scissors  
10½" (27 cm)



**10S-006**  
Sauerb-Ruch  
Sternum  
Scissors 10¼"  
(26 cm)



**10S-007** Lebsche  
Sternum Scissors  
9¾" (25 cm)

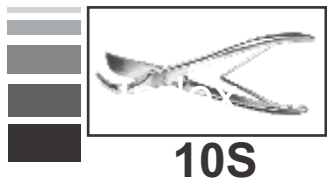

# NEURO SURGERY INSTRUMENTS

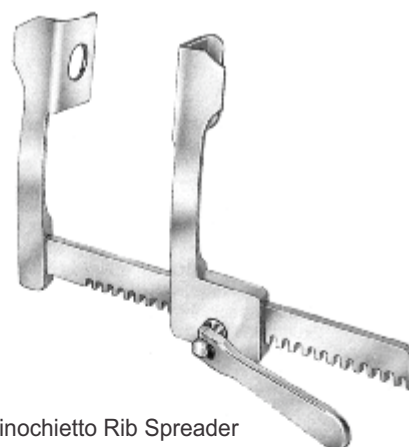
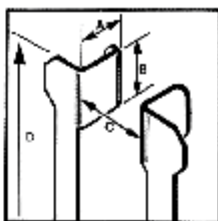

Cooley Rib Spreader

Art.No	A	B	C	D
<b>10S-008</b>	20mm	45mm	140mm	110mm
<b>10S-009</b>	30mm	50mm	180mm	145mm
<b>10S-010</b>	30mm	50mm	200mm	145mm

Finochietto Rib Spreader

Art.No	A	B	C	D
<b>10S-011</b>	30mm	45mm	140mm	110mm
<b>10S-012</b>	42mm	62mm	175mm	140mm
<b>10S-013</b>	75mm	65mm	200mm	140mm

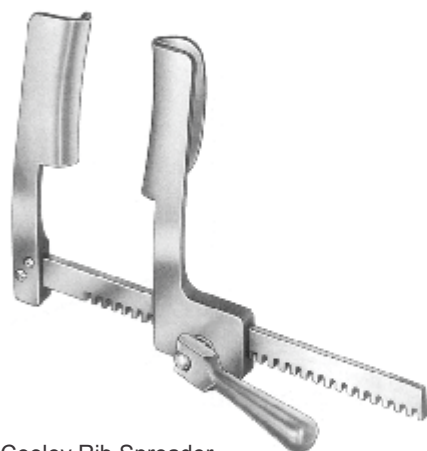

Cooley Rib Spreader

Art.No	A	B	C	D
<b>10S-014</b>	35mm	100mm	180mm	180mm
<b>10S-015</b>	35mm	115mm	230mm	205mm

Burford-Finochitto Rib Spreader

Art.No	A	B	C	D
<b>10S-016</b>	45mm	62mm	180mm	200mm
<b>10S-017</b>	45mm	62mm	250mm	200mm
<b>10S-018</b>	45mm	62mm	300mm	200mm

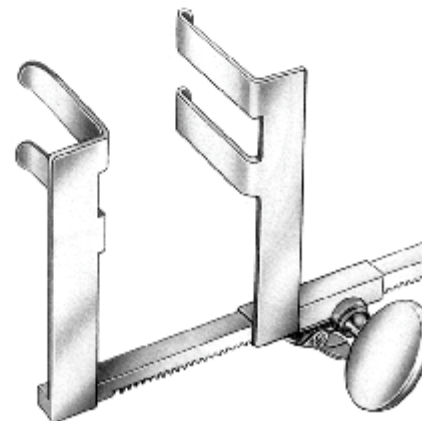
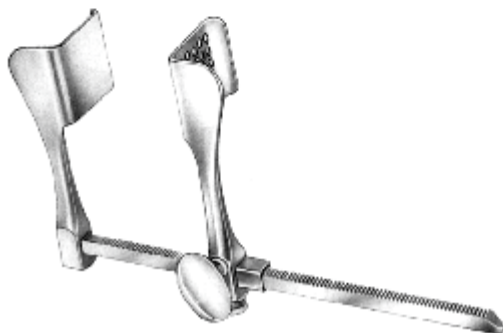

Tuffier Rib Spreader

Art.No	A	B	C	D
<b>10S-019</b>	42mm	45mm	170mm	110mm

Mini Thoracotomy Rib Spreader

Art.No	A	B	C	D
<b>10S-020</b>	38mm	12mm	70mm	90mm



10S

NEURO SURGERY INSTRUMENTS

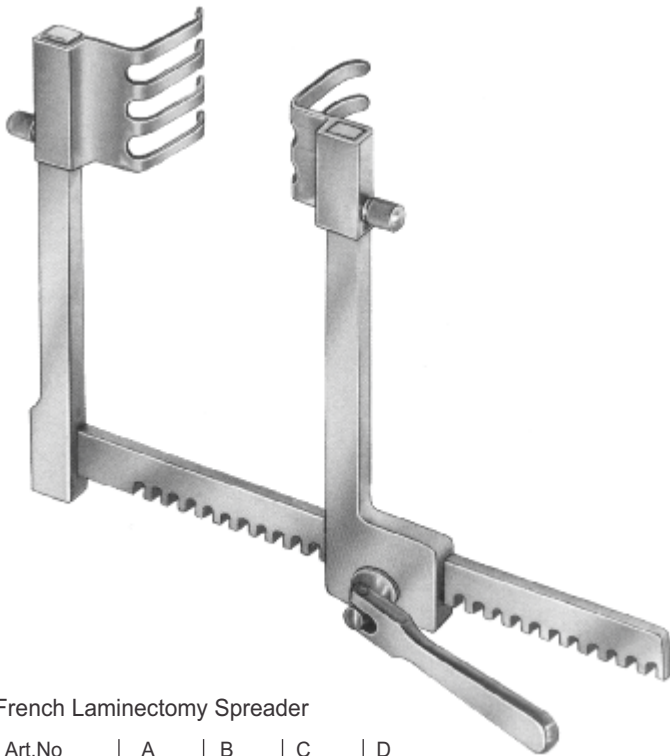

French Laminectomy Spreader

Art.No	A	B	C	D
10S-021	38mm	32mm	130mm	125mm



10S-022  
Bailey-Baby Rib  
Contractors 6" (15 cm)

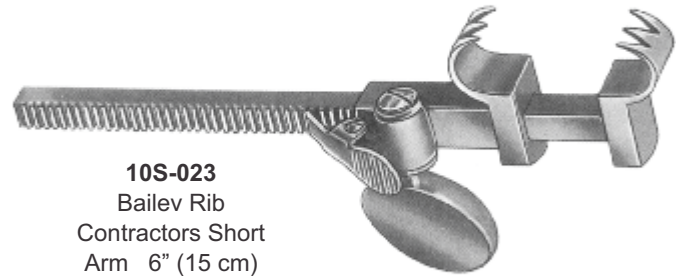

10S-023  
Bailey Rib  
Contractors Short  
Arm 6" (15 cm)



10S-024  
Bailey-Gibbon Rib  
Contractors 6" (15 cm)  
Long Arm



10S-025  
Casper Retractor for Spine



10S-026 | 50 x 25 mm  
10S-027 | 60 x 25 mm



10S-033 | 40 x 23 mm  
10S-034 | 45 x 23 mm  
10S-035 | 50 x 23 mm  
10S-036 | 55 x 23 mm  
10S-037 | 60 x 23 mm



10S-028 | 40 x 23 mm  
10S-029 | 45 x 23 mm  
10S-030 | 50 x 23 mm  
10S-031 | 55 x 23 mm  
10S-032 | 60 x 23 mm



10S-038 | 45 x 23 mm  
10S-039 | 50 x 23 mm  
10S-040 | 55 x 23 mm  
10S-041 | 60 x 23 mm  
10S-042 | 65 x 23 mm

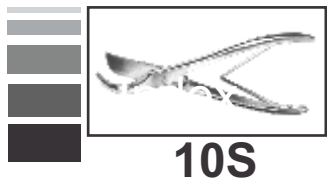

10S

# NEURO SURGERY INSTRUMENTS



**10S-043**  
Crutchfield  
Traction  
Cervical Tongs  
Small



**10S-044**  
Crutchfield  
Traction  
Tongs  
Medium



**10S-045**  
3.5mmO/



**10S-046**  
5mmO/



**10S-047**  
Dahlgren Instruments  
8" (20 cm)



**10S-048**  
De Vilbiss Instruments  
8 3/4" (21 cm)



**10S-049**  
Large Lamina Spreader  
10 3/4" (27 cm)



**10S-050**  
Large Lamina  
Spreader 6 1/2" (16 cm)



**10S-051**  
Cloward Lamina  
Spreader 6 1/2" (16 cm)

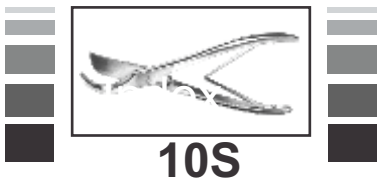

# NEURO SURGERY INSTRUMENTS



ARTICLE #	SIZE
10S-052	6" (15 cm)
10S-053	7½" (19 cm)

McKenzie  
Clip Applying  
Forceps  
Curved



ARTICLE #	SIZE
10S-054	6" (15 cm)
10S-055	7½" (19 cm)

McKenzie  
Clip Applying  
Forceps  
Straight



**10S-056** Raney  
Hemostatic Clip Applying  
Forceps 6" (15 cm)



120 mm, 4 3/4"

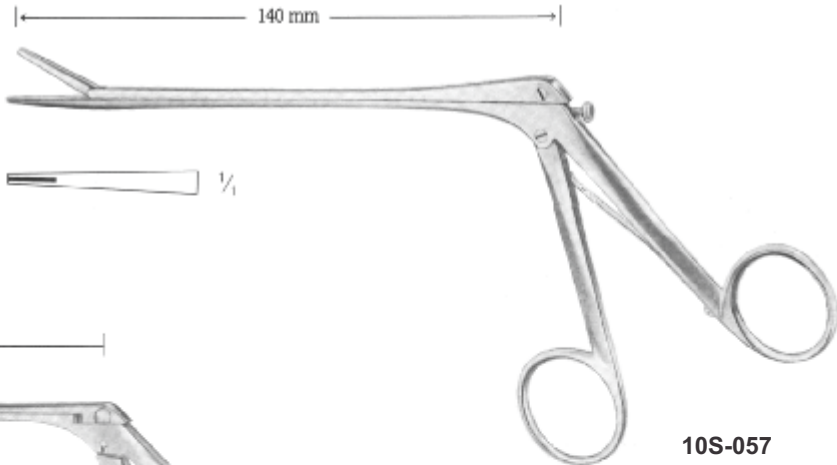

**10S-057**  
Oliveerona-  
Toennis  
(Scoville) 5.5"  
(14 cm)

Art No.	Jaw Size (mm)	Jaw	Length (in.)
10S-058	3.00	STR	4¾ (12 cm)
10S-059	3.6	STR	4¾ (12 cm)
10S-060	4.2	STR	4¾ (12 cm)
10S-061	4.8	STR	4¾ (12 cm)
10S-062	5.8	STR	4¾ (12 cm)
10S-063	3.6	140°UP- CVD	4½ (11.5 cm)
10S-064	4.2	140°UP- CVD	4½ (11.5 cm)
10S-065	4.8	140°UP- CVD	4½ (11.5 cm)

**10S-058 to 10S-065**  
Weil-Blakesley Roungeur





**10S**

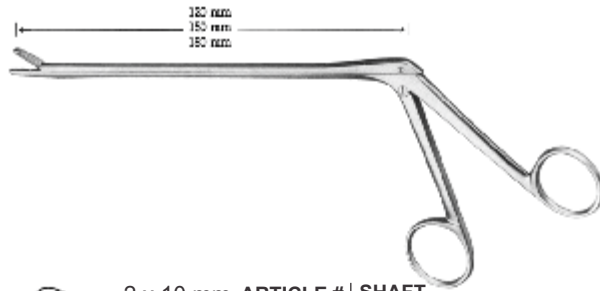

2 x 10 mm	ARTICLE #	SHAFT
	10S-084	120 mm
	10S-085	150 mm
	10S-086	180 mm

3 x 10 mm	ARTICLE #	SHAFT
	10S-087	120 mm
	10S-088	150 mm
	10S-089	180 mm

4 x 10 mm	ARTICLE #	SHAFT
	10S-090	120 mm
	10S-091	150 mm
	10S-092	180 mm

ARTICLE #	SHAFT	2 x 10 mm / 45°
10S-093	120 mm	
10S-094	150 mm	
10S-095	180 mm	

ARTICLE #	SHAFT	3 x 10 mm / 45°
10S-096	120 mm	
10S-097	150 mm	
10S-098	180 mm	

ARTICLE #	SHAFT	4 x 10 mm / 45°
10S-099	120 mm	
10S-100	150 mm	
10S-101	180 mm	

2 x 10 mm / 45°	ARTICLE #	SHAFT
	10S-102	120 mm
	10S-103	150 mm
	10S-104	180 mm

3 x 10 mm / 45°	ARTICLE #	SHAFT
	10S-105	120 mm
	10S-106	150 mm
	10S-107	180 mm

4 x 10 mm / 45°	ARTICLE #	SHAFT
	10S-108	120 mm
	10S-109	150 mm
	10S-110	180 mm

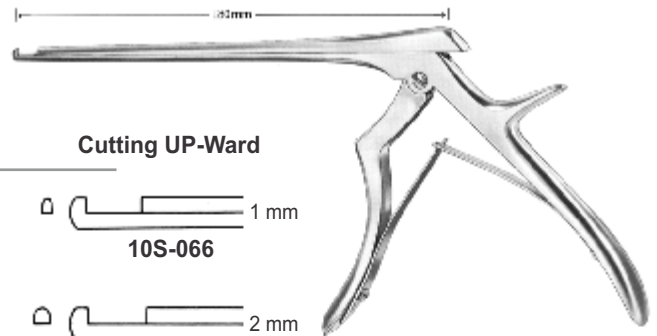

**Cutting UP-Ward**

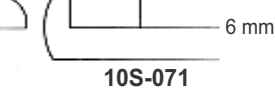
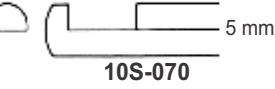
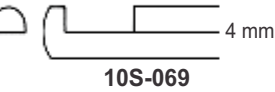
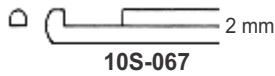
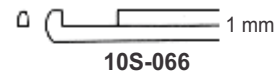

**Cutting 40° Angle**

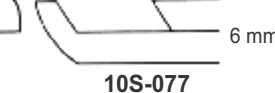
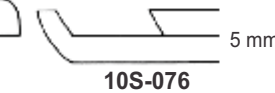
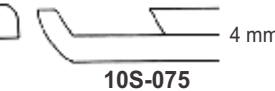
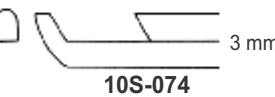
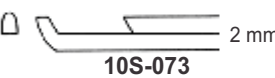
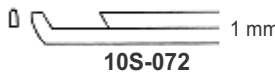

Ferris-Smith-Kerrison

**Cutting Down-Ward**

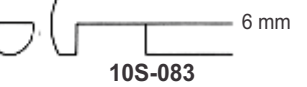
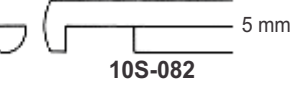
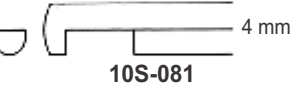
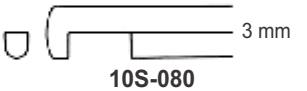
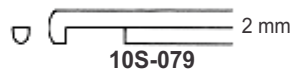
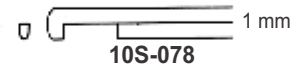



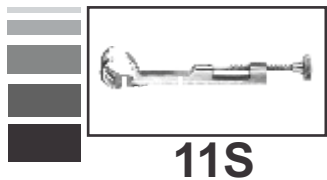

**11S**

**BONE SURGERY INSTRUMENTS**



**11S-001**  
Bone Hand  
Drills 5½"  
(14 cm)



**11S-002**  
Bone Hand  
Drills 5½"  
(14 cm)

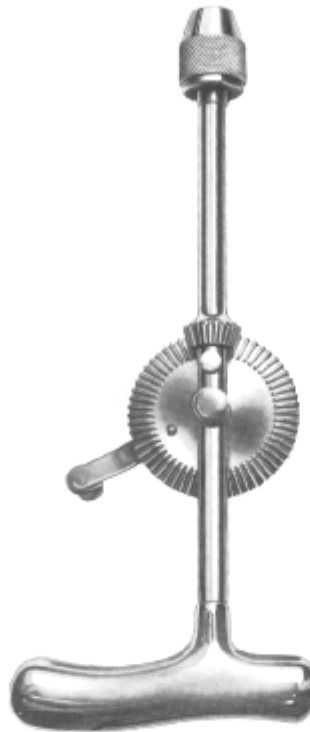

**11S-003**  
Moore Hand Drills



**11S-004**  
9 cm  
Ø 3,2mm



**11S-005**  
7 cm  
Ø 3,2mm



**11S-006**  
Hudson Bone  
Hand Drills 10"  
(27 cm)



**11S-007**  
9 mmØ



**11S-008**  
14 mmØ



**11S-009**  
16 mmØ



**11S-010**  
22 mmØ



**11S-011**  
Cushing  
14 mmØ



**11S-012**  
2 mmØ



**11S-013**  
McKenzie  
13 mmØ



**11S-014**  
Errico  
16 mmØ

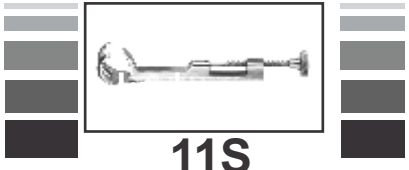

# BONE SURGERY INSTRUMENTS



**11S-015**  
Gigli Saw Handle



**11S-016**  
Gigli Strully Saw Handle



**11S-017**  
Gigli Strully Saw Handle



**11S-018**  
Gigli Strully Saw Handle

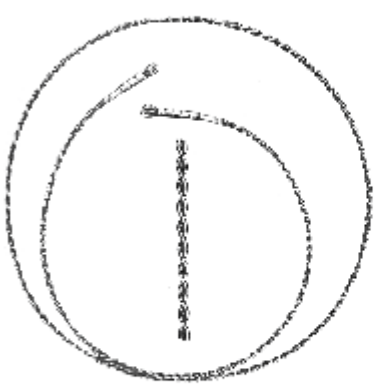

Gigli Saw Wire

ARTICLE #	SIZE
11S-019 A	12" (30 cm)
11S-019 B	20" (51 cm)
11S-019 C	30" (76 cm)



Saw Blade  
**11S-020**  
15mm



**11S-021**  
Charriere  
Resection Saw  
14" (35 cm)



**11S-022**  
Langenbeck  
Saw 9" (23 cm)



**11S-023**  
Charriere  
Saw 10½"  
(27 cm)



**11S-024**  
Satterlee  
Saw 13 ¼"  
(31 cm)

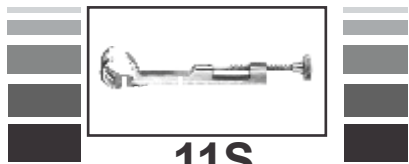

**11S**

# BONE SURGERY INSTRUMENTS



Schede Bone Currettes  
6½" (16 cm)

- Fig, 000  
11S-025
- Fig, 00  
11S-026
- Fig, 0  
11S-027
- Fig, 1  
11S-028
- Fig, 2  
11S-029
- Fig, 3  
11S-030
- Fig, 4  
11S-031



Volkmann Bone Currettes  
6½" (16 cm)

- Fig, 0000  
11S-032
- Fig, 000  
11S-033
- Fig, 00  
11S-034
- Fig, 0  
11S-035
- Fig, 1  
11S-036
- Fig, 2  
11S-037
- Fig, 3  
11S-038
- Fig, 4  
11S-039
- Fig, 5  
11S-040
- Fig, 6  
11S-041



Bruns Bone Currettes  
6½" (16 cm)

- Fig, 0000  
11S-042
- Fig, 000  
11S-043
- Fig, 00  
11S-044
- Fig, 0  
11S-045
- Fig, 1  
11S-046
- Fig, 2  
11S-047
- Fig, 3  
11S-048
- Fig, 4  
11S-049
- Fig, 5  
11S-050
- Fig, 6  
11S-051



Spratt Bone Currettes  
6½" (16 cm)

- Fig, 0000  
11S-052
- Fig, 000  
11S-053
- Fig, 00  
11S-054
- Fig, 0  
11S-055
- Fig, 1  
11S-056
- Fig, 2  
11S-057
- Fig, 3  
11S-058
- Fig, 4  
11S-059
- Fig, 5  
11S-060

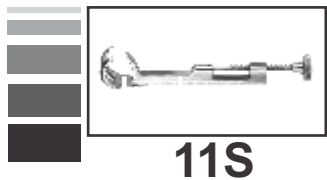

**11S**

# BONE SURGERY INSTRUMENTS

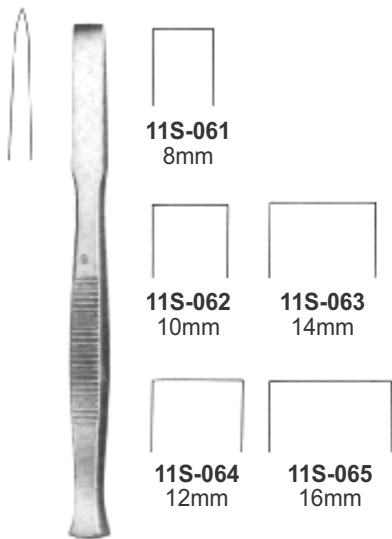

**11S-061**  
8mm

**11S-062**  
10mm

**11S-063**  
14mm

**11S-064**  
12mm

**11S-065**  
16mm

Bone Chisels  
5 ¼ (13,5cm)

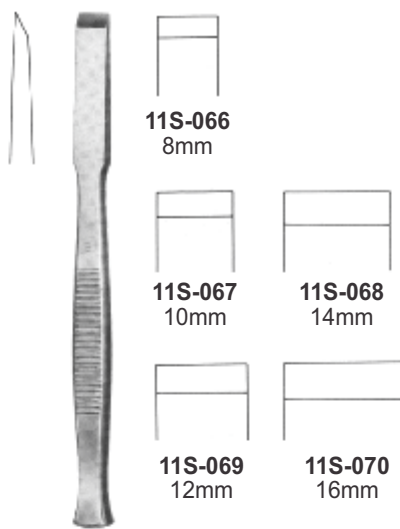

**11S-066**  
8mm

**11S-067**  
10mm

**11S-068**  
14mm

**11S-069**  
12mm

**11S-070**  
16mm

Bone Chisels  
5 ¼ (13,5cm)

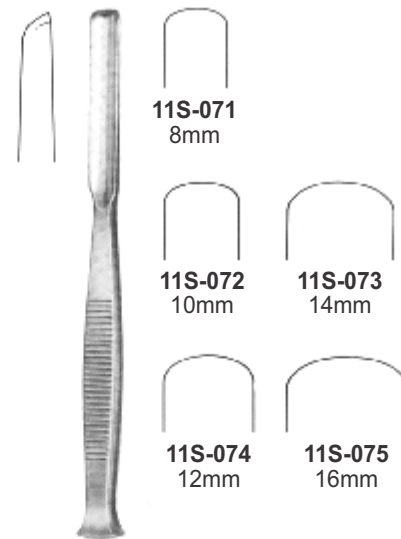

**11S-071**  
8mm

**11S-072**  
10mm

**11S-073**  
14mm

**11S-074**  
12mm

**11S-075**  
16mm

Bone Gouge  
5 ¼ (13,5cm)

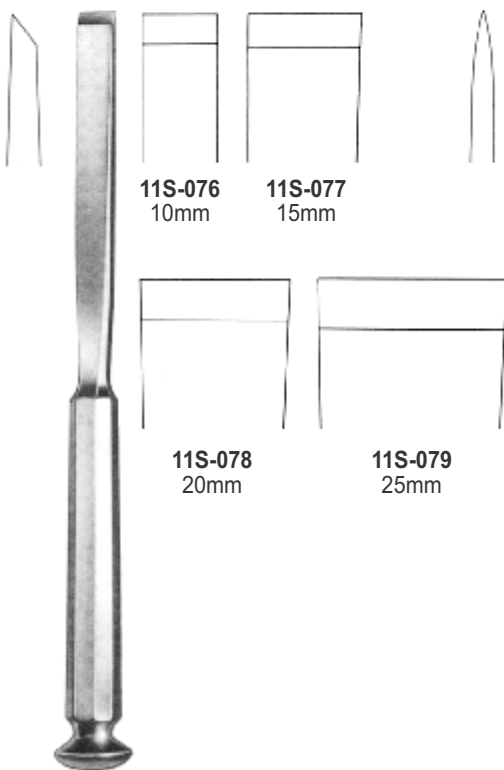

**11S-076**  
10mm

**11S-077**  
15mm

**11S-078**  
20mm

**11S-079**  
25mm

Stille Bone Chisels  
8" (20 cm)

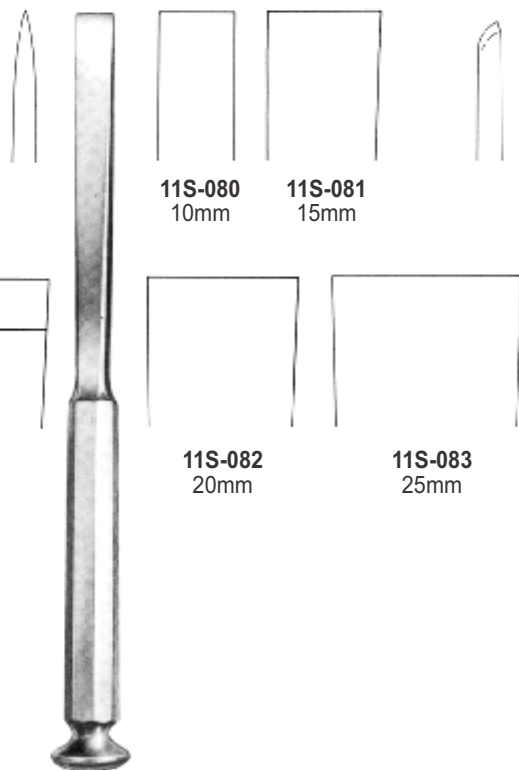

**11S-080**  
10mm

**11S-081**  
15mm

**11S-082**  
20mm

**11S-083**  
25mm

Stille Bone Chisels  
8" (20 cm)

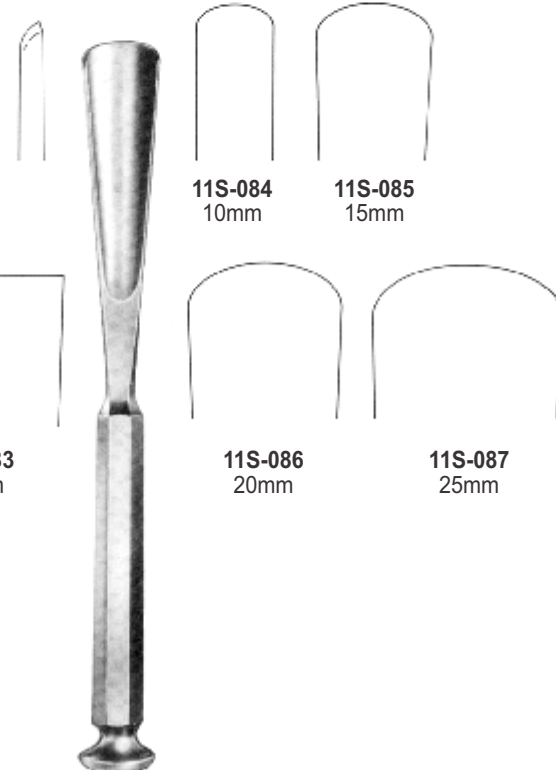

**11S-084**  
10mm

**11S-085**  
15mm

**11S-086**  
20mm

**11S-087**  
25mm

Stille Bone Gouge  
8" (20 cm)

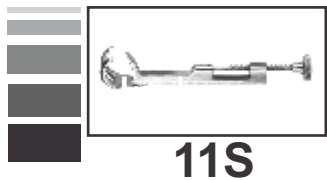

**11S**

**BONE SURGERY INSTRUMENTS**



**Williger Hammer**  
9½" (24 cm)

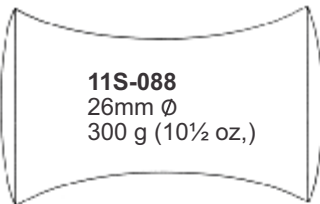

**11S-088**  
26mm Ø  
300 g (10½ oz.)

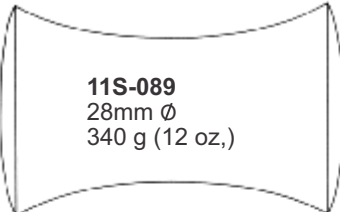

**11S-089**  
28mm Ø  
340 g (12 oz.)

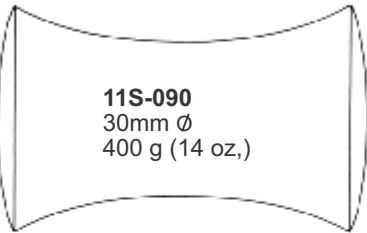

**11S-090**  
30mm Ø  
400 g (14 oz.)



**11S-091**  
**Gerog Mallet Hammer**  
Weight

Head Weight  
227 G



**Doyen Hammer**  
8 ¼" (21 cm)

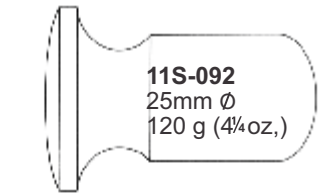

**11S-092**  
25mm Ø  
120 g (4¼ oz.)

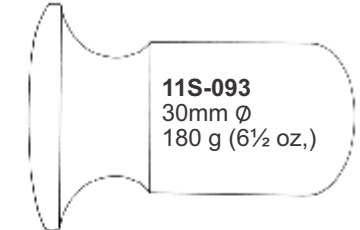

**11S-093**  
30mm Ø  
180 g (6½ oz.)

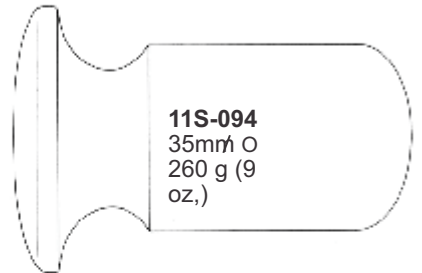

**11S-094**  
35mm Ø  
260 g (9 oz.)



**Collin Hammer**  
8" (20 cm)

**11S-095**  
220 g (7¾ oz.)



**Lucae Hammer**  
7½" (19 cm)

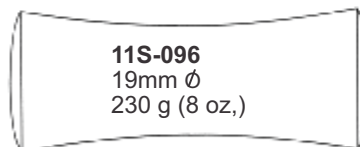

**11S-096**  
19mm Ø  
230 g (8 oz.)

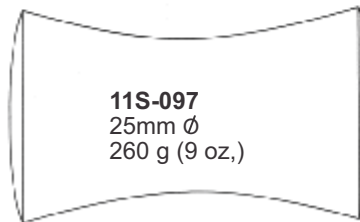

**11S-097**  
25mm Ø  
260 g (9 oz.)



**11S-098**  
**Miltex Mallet**  
11" (27.9cm)

Head Weight  
450 G

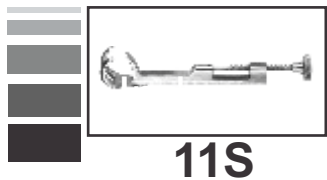

11S

# BONE SURGERY INSTRUMENTS

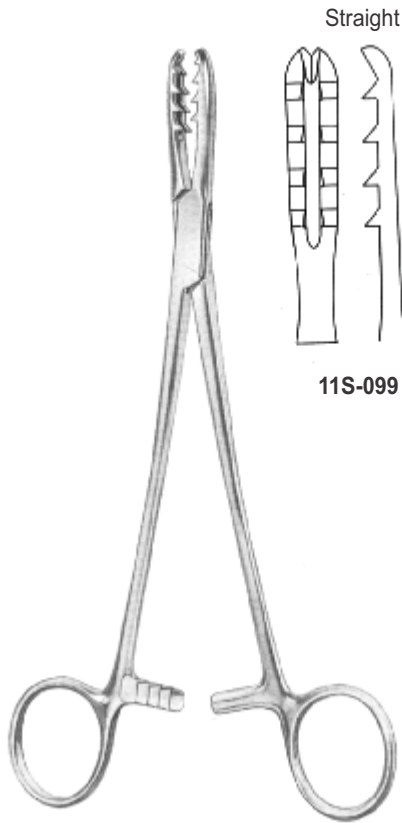

Bircher-Ganske Forceps  
8" (20 cm)

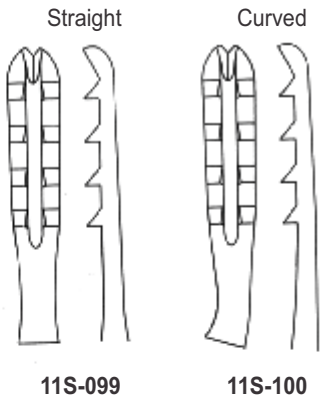

11S-101  
Lewin  
7" (17,5 cm)



11S-102  
Bone Holding Forceps  
5 1/4" (13,5cm)

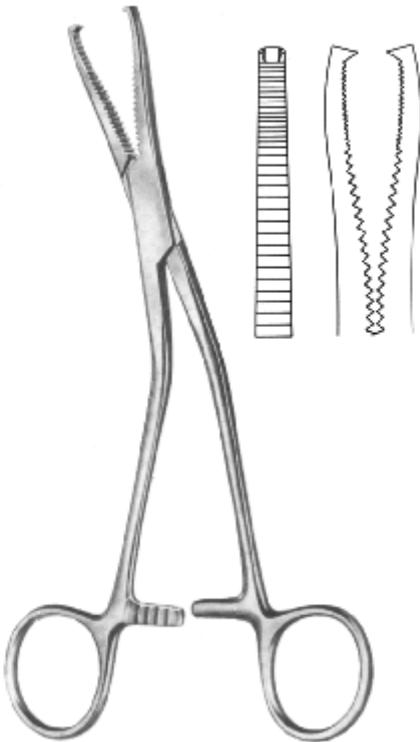

11S-103 Dingmann Bone  
Forceps 7 1/2" (19 cm)



11S-104  
Martin Bone Forceps 7 1/2" (19 cm)



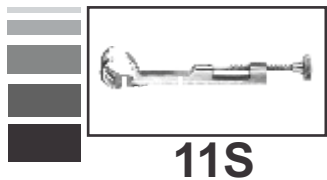

# BONE SURGERY INSTRUMENTS



**11S-105**  
Bone Holding Forceps  
5 1/2" (14 cm)



**11S-106**  
Bone Holding Forceps  
5 1/4" (13,5cm)



**11S-107**  
Langenbeck  
Bone Holding  
Forceps 8 1/4" (21  
cm)

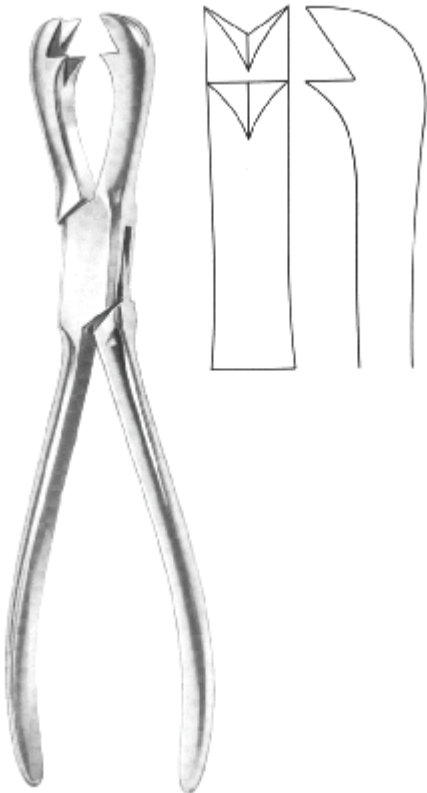

**11S-108**  
Fergusson Bone Holding  
Forceps 8 1/4" (21 cm)

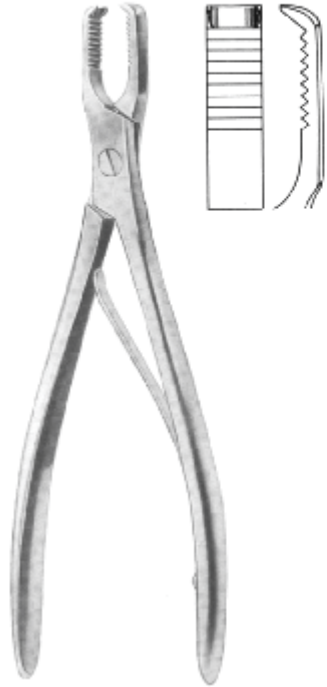

**11S-109**  
Frosch Bone Holding  
Forceps 7" (18 cm)



**11S-110**  
Bone Holding  
Forceps 8" (20 cm)

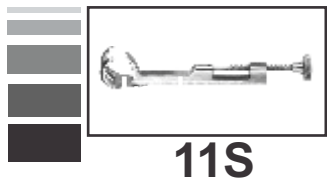

**11S**

**BONE SURGERY INSTRUMENTS**

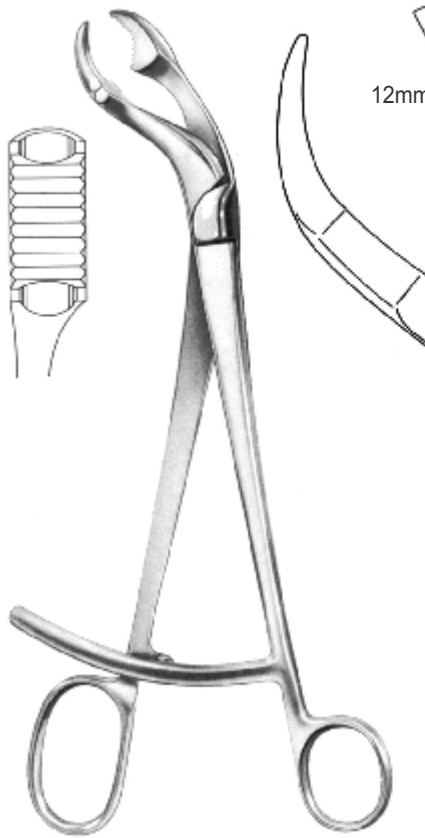

Verbrugge Bone Holding Forceps

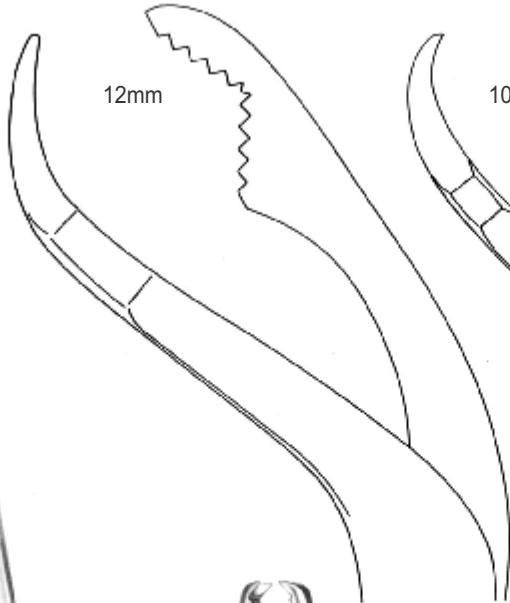

12mm

**11S-111**  
11" (27 cm)

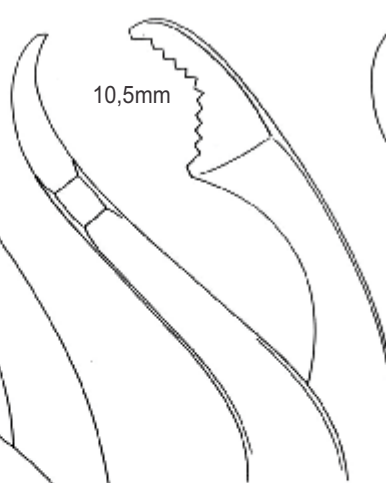

10,5mm

**11S-112**  
10½" (26 cm)

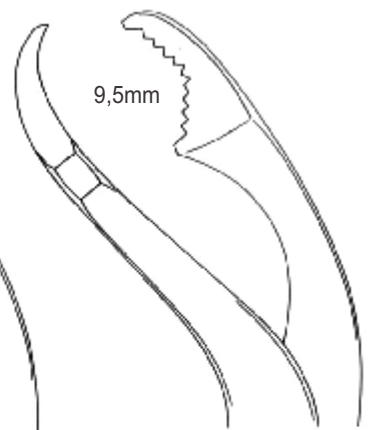

9,5mm

**11S-113**  
10" (25 cm)



**11S-114**  
Verbrugge Bone Holding Forceps  
6 ¾" (17,5cm)

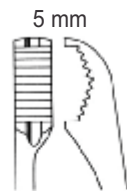

5 mm



**11S-115**  
LANE Bone Holding Forceps  
13" (33 cm)



**11S-116**  
LANE Bone Holding Forceps  
13" (33 cm)



**11S-117**  
Lowmann Bone Holding Forceps  
7" (18 cm)

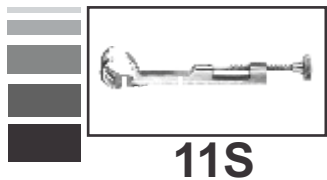

11S

# BONE SURGERY INSTRUMENTS



Kern Bone Holding Forceps

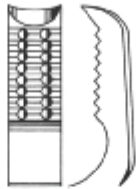

**11S-118**  
6 3/4" (17 cm)

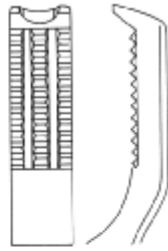

**11S-119**  
8 1/4" (21 cm)



**11S-120**  
Semb Bone Holding Forceps  
7 1/2" (19 cm)

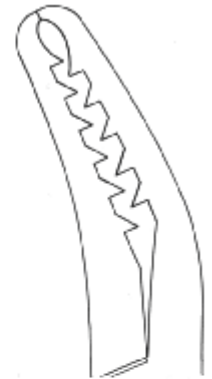

Farabeuf Bone Holding Forceps

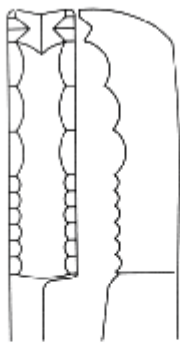

ARTICLE #	SIZE
11S-121	9" (23 cm)
11S-122	10 1/4" (26 cm)

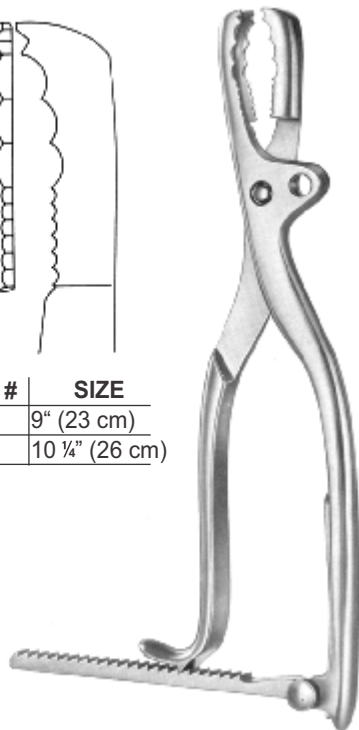

**11S-123**  
Farabeuf-Lambotte  
Bone Holding Forceps  
10 1/4" (26 cm)

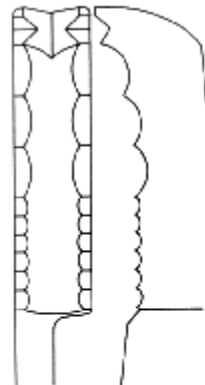

Lambotte Bone Holding Forceps

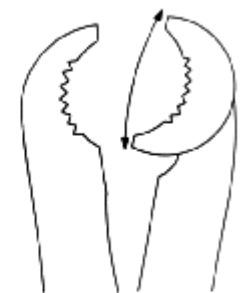

ARTICLE #	SIZE
11S-124	8" (22 cm)
11S-125	10 1/2" (27 cm)
11S-126	12" (30 cm)

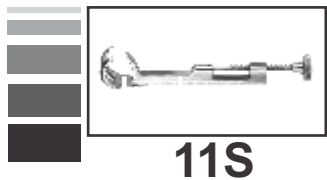

**11S**

**BONE SURGERY INSTRUMENTS**



**11S-127**  
Hennig Spreader  
11" (28cm)



**11S-128**  
3 Prong Cast  
Spreader 9" (23 cm)



**11S-129**  
Eangle Saw



**11S-130 7" (18 cm)**  
Wolfe Buechier Cast  
Breaker

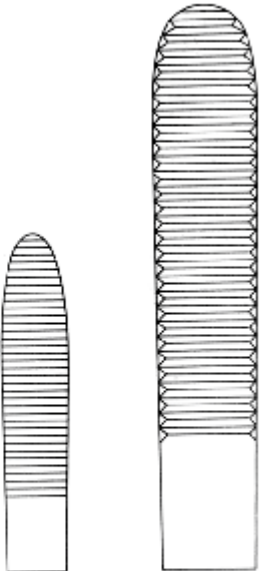

**11S-131**  
10" (24 cm)



Stille- Cast Shears

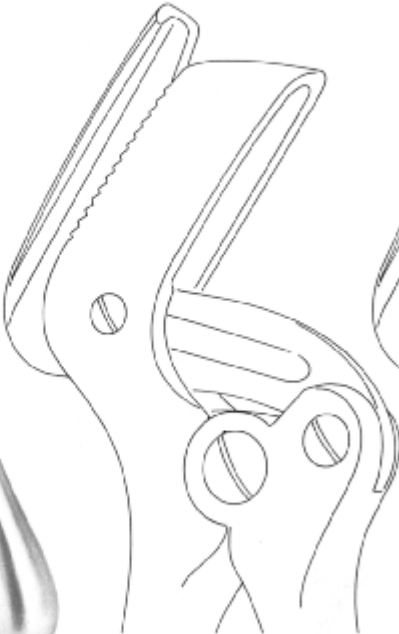

**11S-132**  
8" (23 cm)

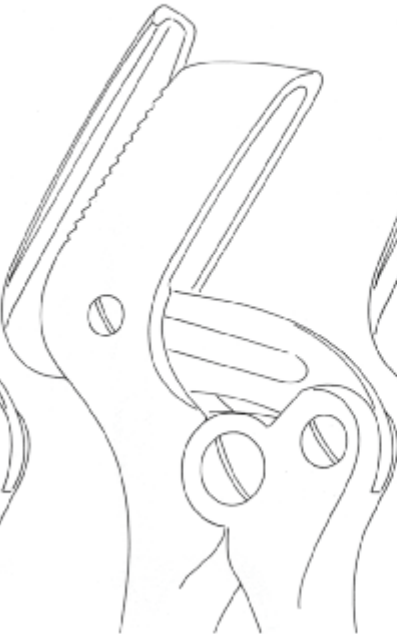

**11S-133**  
11" (26 cm)

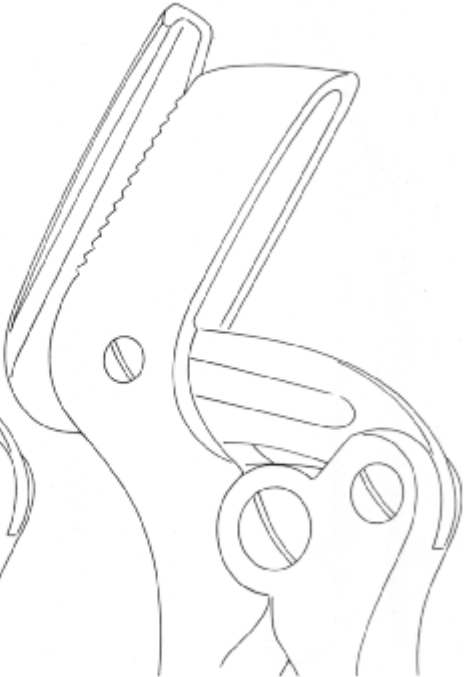

**11S-134**  
15" (37 cm)

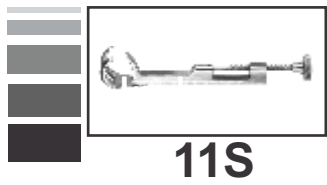

11S

# BONE SURGERY INSTRUMENTS



Blumenthal Bone Rongeur  
6" (15 cm)



11S-135



11S-136



11S-137



Luer Bone Rongeur  
7" (15 cm)



11S-138



11S-139



11S-140



Hartmann Bone Rongeur  
7" (18,5cm)



11S-141



Luer Bone Rongeur  
7" (18 cm)



11S-142



11S-143



Jansen Bone Rongeur Forceps  
7" (18 cm)



11S-144



11S-145



11S-146



Lempert Bone Rongeur Forceps  
7½" (19 cm)



11S-147



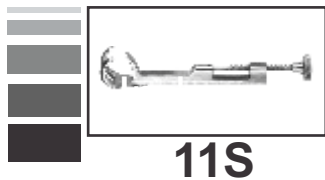

**11S**

**BONE SURGERY INSTRUMENTS**



**11S-148**  
Ruskin Bone Rongeur Forceps  
7" (18 cm)



**11S-149**  
Ruskin Bone Rongeur Forceps  
9" (23 cm)



**11S-150**  
Stille-Ruskin  
Bone Rongeur  
Forceps 9" (23 cm)



**11S-151**  
Stille Bone Rongeur Forceps  
9" (23 cm)



**11S-155**



**11S-158**



**11S-152**



**11S-153**



**11S-156**



**Echlin Bone Rongeur Forceps**  
9" (23 cm)



**11S-154**



**Stille-Luer Bone Rongeur Forceps**  
8 3/4" (22 cm)



**11S-157**  
Semb Bone Rongeur  
Forceps 9" (23 cm)



**Sauerbruch  
Bone Rongeur  
Forceps 12" (30 cm)**



**11S-159**





**11S**

**BONE SURGERY INSTRUMENTS**



Liston Bone Cutting Forceps  
Straight



**11S-160**  
5½" (14 cm)



**11S-161**  
6¾" (17 cm)



**11S-162**  
7½" (19 cm)



**11S-163**  
8 ¼" (22 cm)



Liston Bone Cutting Forceps  
Curved



**11S-164**  
5½" (14 cm)



**11S-165**  
6 ¾" (17 cm)



**11S-166**  
7½" (19 cm)



**11S-167**  
8 ¼" (22 cm)



**11S-168**  
Rusking Bone Cutting Forceps  
6" (15 cm)



**11S-169**  
Markwalder Bone Cutting Forceps  
8" (20 cm)



Ruskin-Liston  
Bone Cutting Forceps  
7½" (18,5cm)

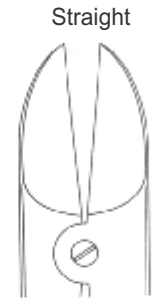

**11S-170**



**11S-171**

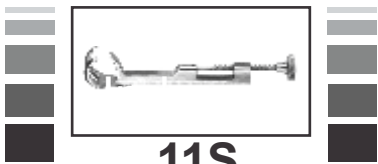

**11S**

**BONE SURGERY INSTRUMENTS**



**11S-172**  
Cleveland  
Bone Cutting  
Forceps 7" (17  
cm)



**11S-173**  
Cleveland  
Bone Cutting  
Forceps 6" (15  
cm)

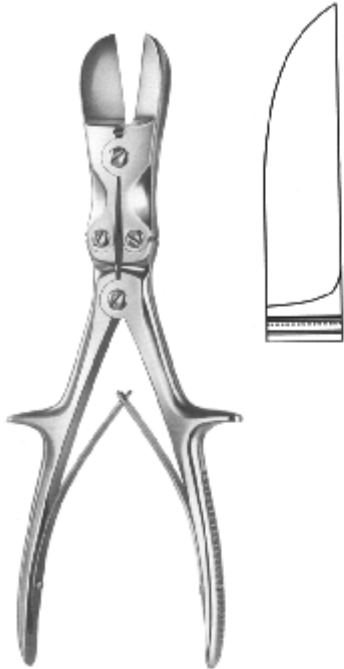

**11S-174** Stille-Liston  
Bone Cutting Forceps,  
Straight 10½" (27 cm)

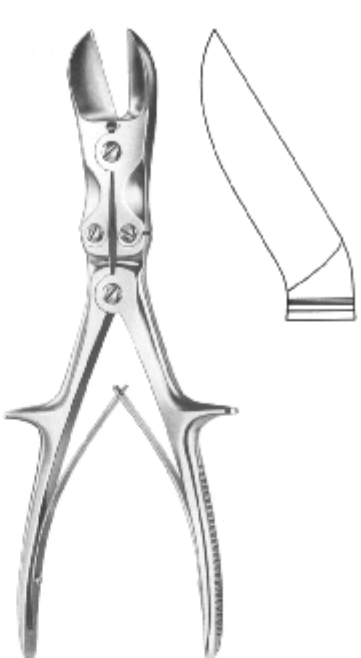

**11S-175** Stille-Liston  
Bone Cutting Forceps,  
Curved 10½" (27 cm)

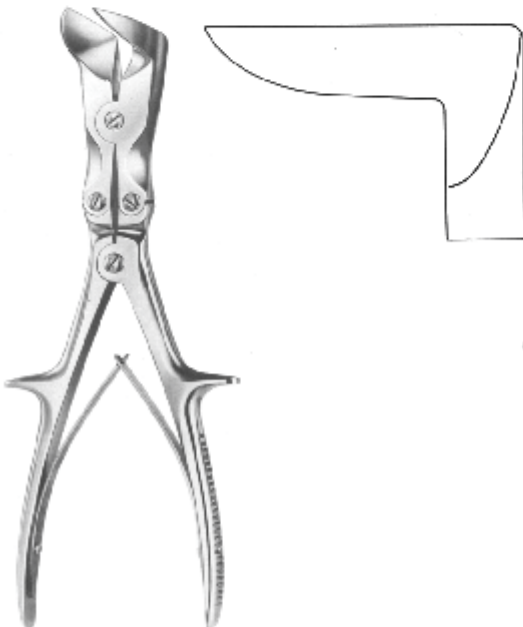

**11S-177**  
Stille-Liston  
Bone Cutting Forceps  
10½" , Curved

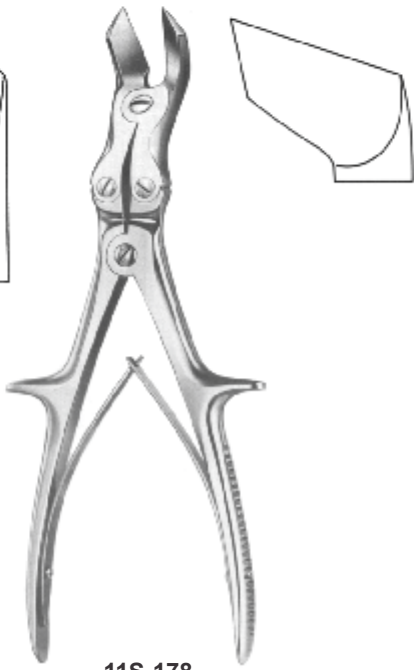

**11S-178**  
Liston-Key  
Bone Cutting  
Forceps 10½"  
(27 cm)

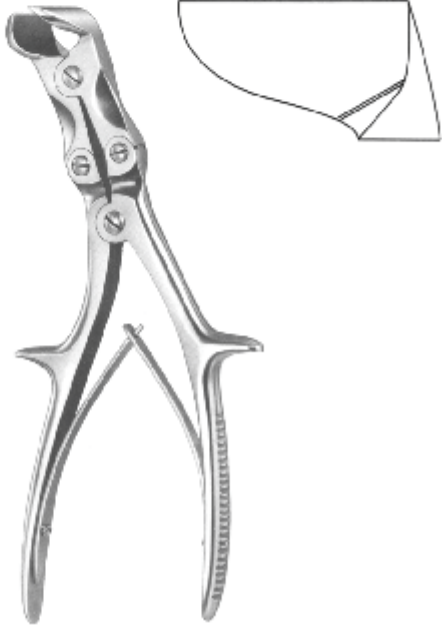

**11S-179** Semb  
Bone Cutting  
Forceps 9½"  
(24 cm)

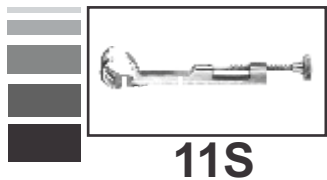

# BONE SURGERY INSTRUMENTS



**11S-180**  
Flat Nose  
Plier 6½"  
(17 cm)

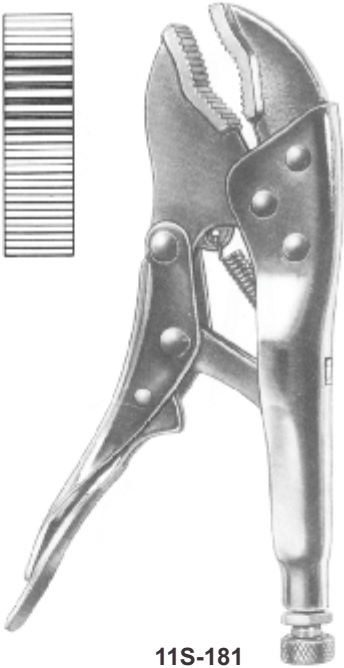

**11S-181**  
Grip Plier  
7" (18 cm)



**11S-182**  
Wire Cutting  
Plier 9" (23  
cm)



**11S-183**  
Bolt Cutter  
12" (30 cm)



**11S-184**  
Pin Cutter  
18½" (47 cm)

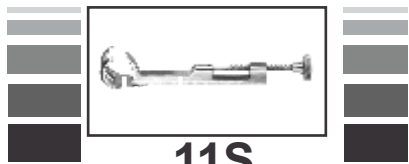

**11S**

# BONE SURGERY INSTRUMENTS



**11S-185**  
Wire Cutting Pliers  
6" (16 cm)



**11S-186**  
Diamant Wire Cutting  
Pliers 6" (16 cm)



**11S-187**  
Diamant Wire Cutting  
Pliers 6" (15 cm)



**11S-188**  
Flat Nose  
Pliers 7"  
(17 cm)



Flat Nose Pliers  
7" (18 cm)



**11S-189**



**11S-190**



**11S-191**



Flat Nose Pliers  
7" (18 cm)



**11S-192**

# GYNACOLOGICAL & OBSTETRICAL INSTRUMENTS

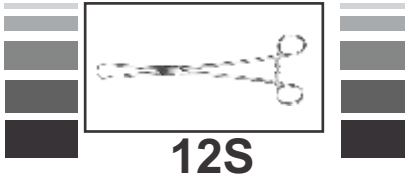

**12S-001**  
Pozzi Tenaculum  
Forceps 10" (25 cm)



**12S-002**  
Schroeder  
Tenaculum Forceps  
10" (25 cm)



**12S-003**  
Barrett Tenaculum  
Forceps 7" (18 cm)



Meseux Tenaculum Forceps, Straight



Meseux Curved Tenaculum Forceps

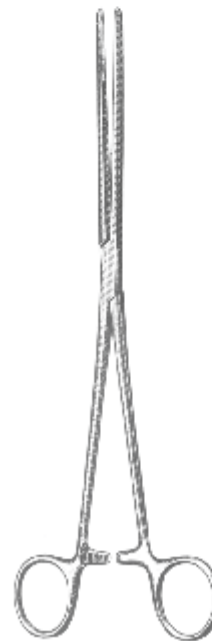

**12S-010**  
Bozeman Uterine  
Dressing Forceps 10½"  
(26,5 cm)



**12S-011**  
Bozeman Uterine  
Dressing Forceps 10½"  
(26,5 cm)

ARTICLE #	SIZE	WIDE AT TIP	ARTICLE #	SIZE	WIDE AT TIP
12S-004	9½" (24cm)	6 mm	12S-007	9½" (24cm)	6 mm
12S-005	9½" (24cm)	8 mm	12S-008	9½" (24cm)	8 mm
12S-006	9½" (24cm)	10 mm	12S-009	9½" (24cm)	10 mm

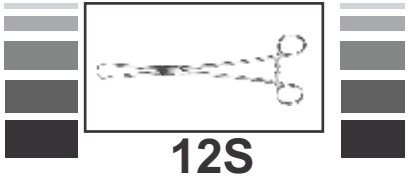

12S

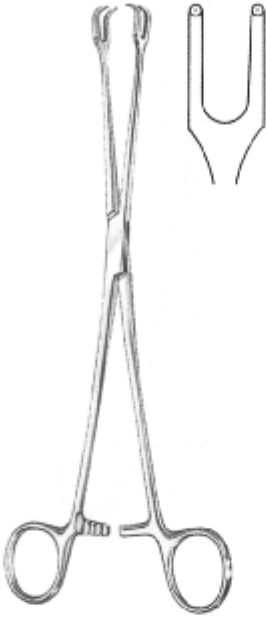

**12S-012**  
Schroeder 2x2  
Tenaculum Forceps 9½"  
(24 cm)



**12S-013**  
Schroeder 2x2  
Curved Tenaculum  
Forceps  
9¾" (25 cm)



**12S-014**  
Pratt Tenaculum  
Forceps 10" (26 cm)



**12S-015**  
Jacobs Tenaculum  
Forceps 8¼" (21 cm)



**12S-016**  
Jacobs Tenaculum  
Forceps 8¼" (21 cm)



**12S-017**  
Teale Tenaculum  
Forceps 9" (23 cm)



# GYNACOLOGICAL & OBSTETRICAL INSTRUMENTS

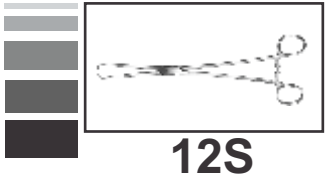

Hegar Dilator, Single End

<b>12S-018A</b>	Set of 14 Pcs	14 to 17 mm
<b>12S-018B</b>	Set of 26 Pcs	1 to 26 mm

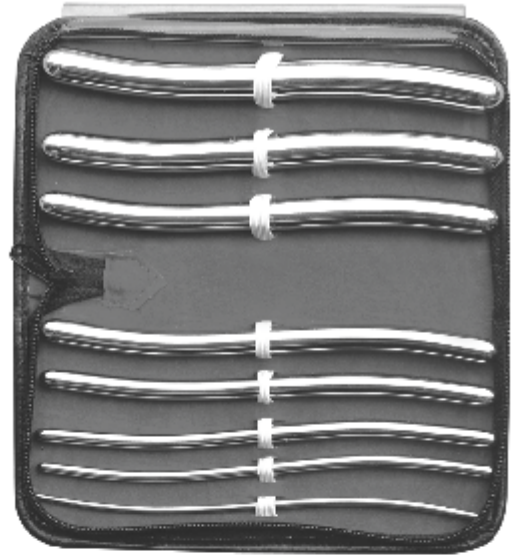

Hegar Dilator, Double End

<b>12S-018C</b>	Set of 8 Pcs	3/4 to 17/18 mm
<b>12S-018D</b>	Set of 13 Pcs	1/2 to 25/26 mm

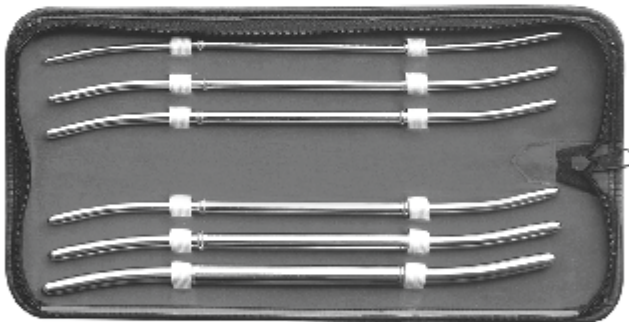

**12S-018E**

Hank Uterine Dilator  
Set of 6 Pcs 9/10 to 19/20 FR

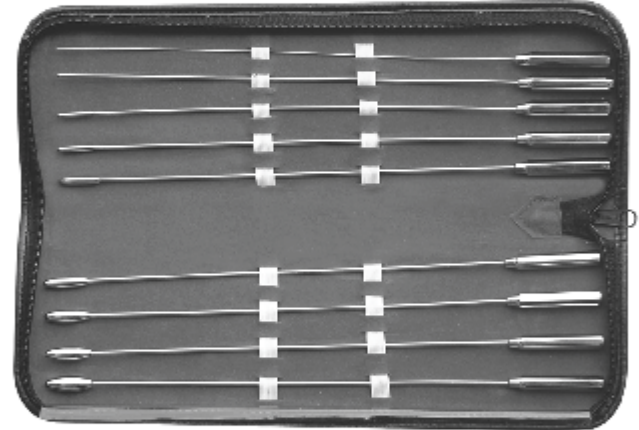

**12S-018F**

De-Bakey Vascular Dilator  
Set of 9 Pcs, 2, 2.5, 3, 3.5, 4, 4.5, 5, 7, 9 mm

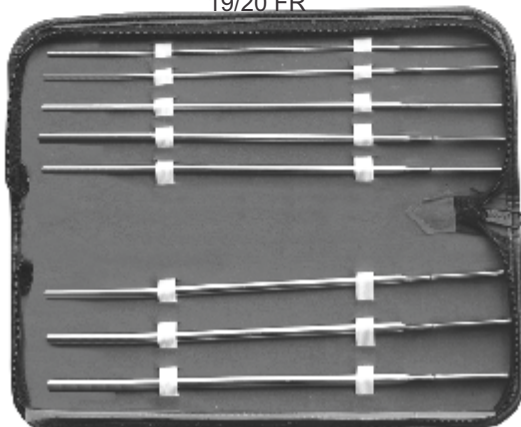

**12S-018G**

Dittel Sound Straight  
Set of 8 Pcs,  
8,10,12,14,16,18,20,22 FR

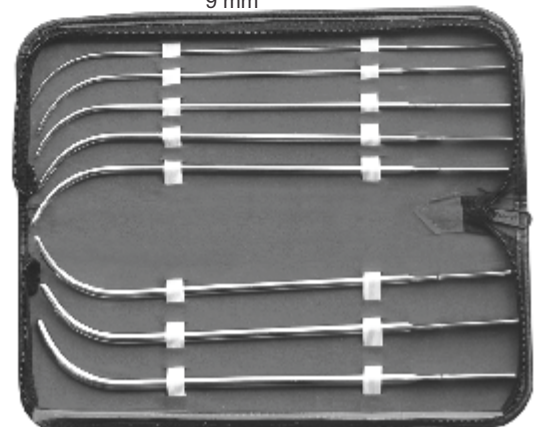

**12S-018H**

Van Buren Sound  
Set of 8 Pcs,  
8,10,12,14,16,18,20,22 FR

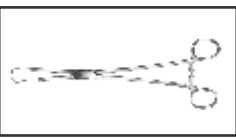

12S

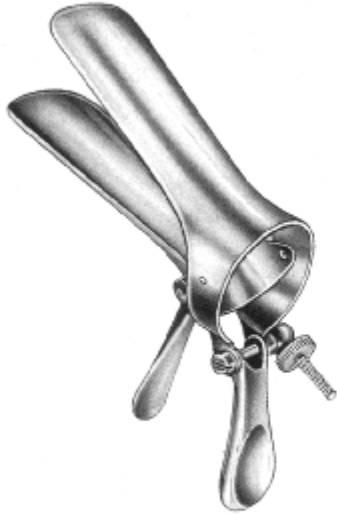

Cusco Vaginal Specula

ARTICLE #	SIZE
12S-020	75 x 32mm
12S-021	85 x 35mm
12S-022	100 x 35mm
12S-023	75 x 17mm

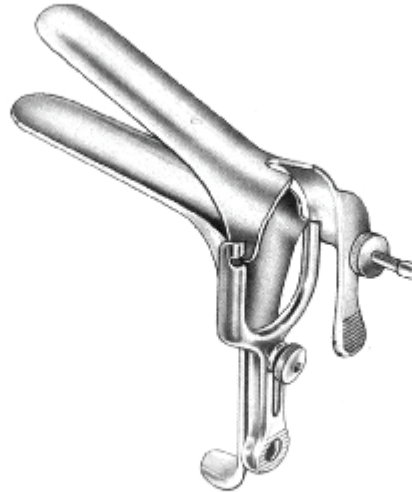

Pederson Vaginal Specula

ARTICLE #	SIZE
12S-024	75 x 13mm
12S-025	100 x 22mm
12S-026	120 x 25mm



Grave Vaginal Specula

ARTICLE #	SIZE
12S-027	75 x 20mm
12S-028	95 x 35mm
12S-029	115 x 35mm

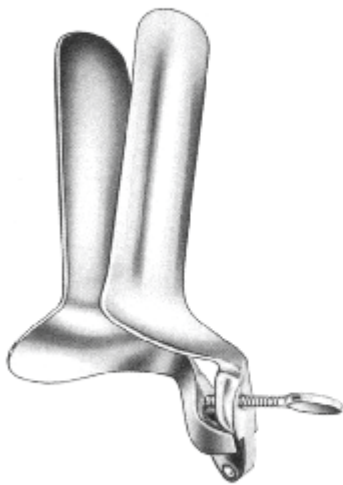

Collin Vaginal Specula

ARTICLE #	SIZE
12S-030	85 x 30mm
12S-031	100 x 35mm
12S-032	110 x 40mm



Sims Vaginal Specula

ARTICLE #	SIZE
12S-033	60 x 25/30mm
12S-034	70 x 30/35mm
12S-035	80 x 35/40mm

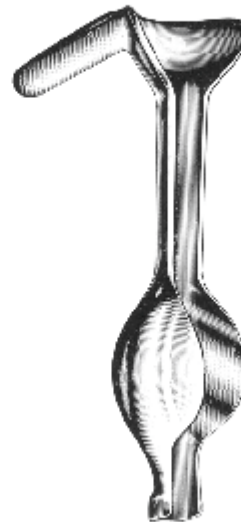

Auvard Weighted Vaginal Specula

ARTICLE #	
12S-036	2 lbs
12S-037	2,5 lbs
12S-038	3 lbs

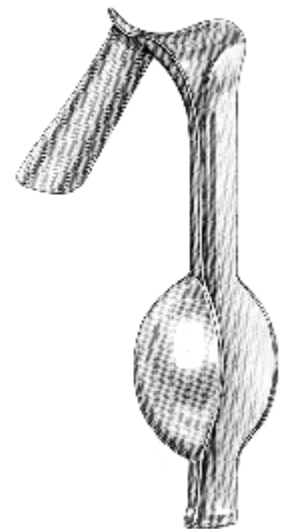

12S-039

Weighted Vaginal Specula 2,5 lbs

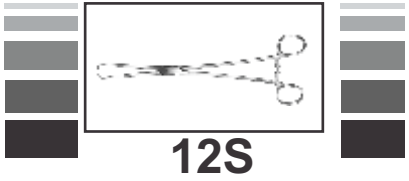

Kristeller Vaginal Specula

12S-040	#000	70 x 27mm
12S-041	#00	80 x 30mm
12S-042	#0	90 x 36mm
12S-043	#1	110 x 27mm
12S-044	#2	110 x 30mm
12S-045	#3	110 x 36mm



Kristeller Vaginal Specula

12S-046	#000	75 x 23mm
12S-047	#00	85 x 26mm
12S-048	#0	100 x 32mm
12S-049	#1	115 x 23mm
12S-050	#2	115 x 26mm
12S-051	#3	115 x 32mm



Kristeller Vaginal Specula Set

12S-052	#000
12S-053	#00
12S-054	#0
12S-055	#1
12S-056	#2
12S-057	#3



Doyen Vaginal Specula

12S-058	55 x 35mm
12S-059	85 x 35mm
12S-060	115 x 35mm



Doyen Vaginal Specula

12S-061	55 x 45mm
12S-062	85 x 45mm
12S-063	115 x 45mm



Doyen Vaginal Specula

12S-064	55 x 60mm
12S-065	85 x 60mm
12S-066	115 x 60mm

# GYNACOLOGICAL & OBSTETRICAL INSTRUMENTS

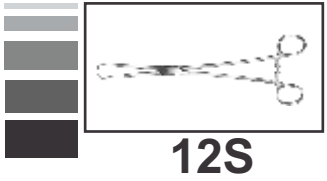

**12S-067**  
Sims Uterine  
Sound 13" (32 cm)



**12S-068**  
Martin Uterine  
Sound 13" (32 cm)



Sims Uterine Curettes  
12½" (31 cm)

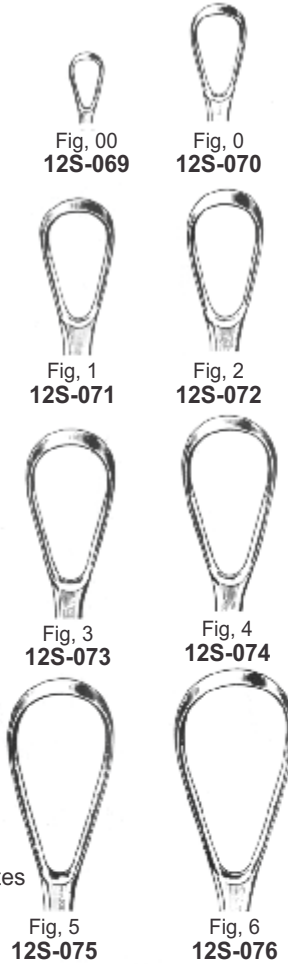

Thomas Uterine Curettes  
12½" (31 cm)

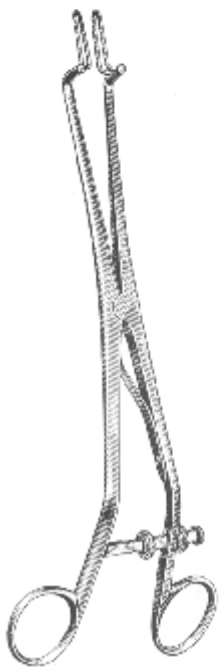
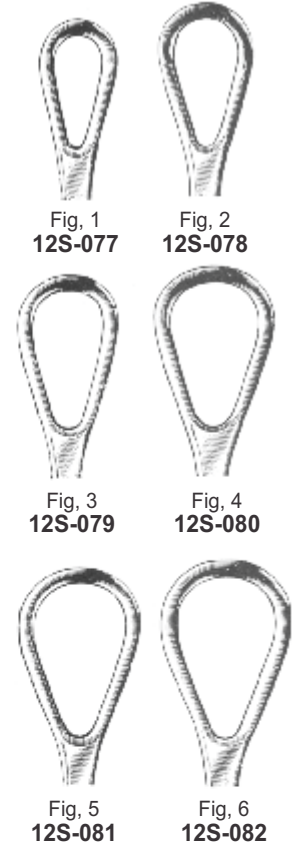

**12S-083**  
Kogan Endocervical  
Speculum 9½" (24 cm)

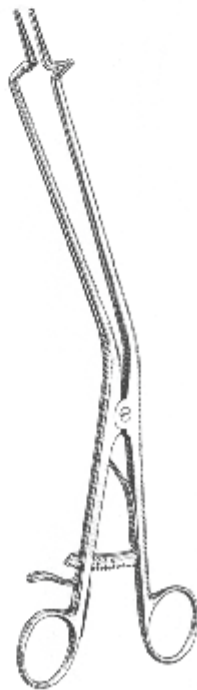

**12S-084**  
Kogan Endocervical  
Speculum 11" (28 cm)

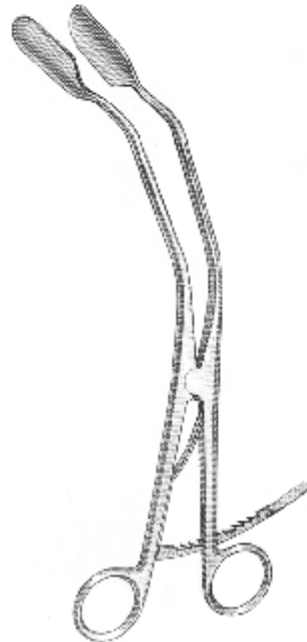

**12S-085**  
Leep Lateral Vaginal  
Retractor 8 ¼" (21 cm)

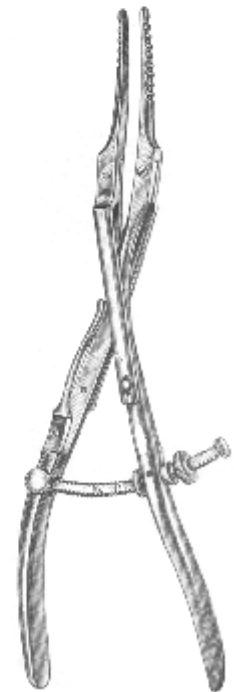

**12S-086**  
Goodell Uterine  
Dilator 10½"  
(26,5 cm)



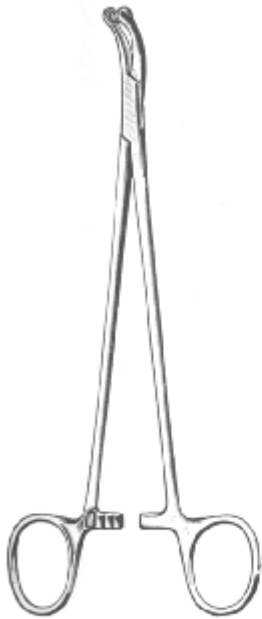
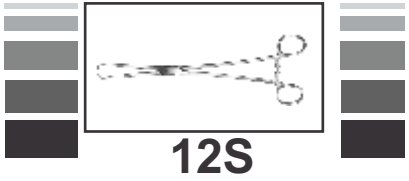

**12S-087**  
Gaylor Uterine  
Biopsy Forceps 8½"  
(21,5 cm)



Thomas-Gaylor Uterine Biopsy Forceps

ARTICLE #	SIZE
12S-088	8½" (21,5 cm)
12S-089	9½" (24 cm)

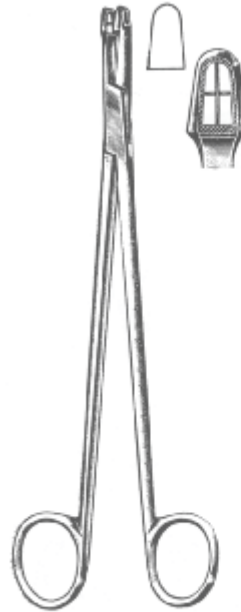

**12S-090**  
Schubert Uterine  
Biopsy Forceps 8½"  
(21,5 cm)



**12S-091**  
Schubert Uterine  
Biopsy Forceps 8½"  
(21,5 cm)

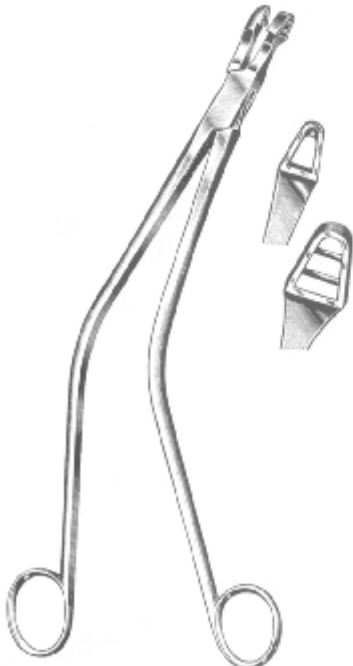

**12S-092**  
Schubert Uterine Biopsy  
Forceps 11" (28 cm)



**12S-093**  
Schubert Uterine Biopsy  
Forceps 11" (28 cm)



**12S-094**  
Gellborn Uterine Biopsy Forceps  
9½" (24 cm)

# GYNACOLOGICAL & OBSTETRICAL INSTRUMENTS

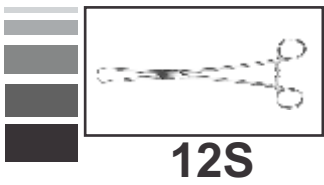

12S

SHAFT

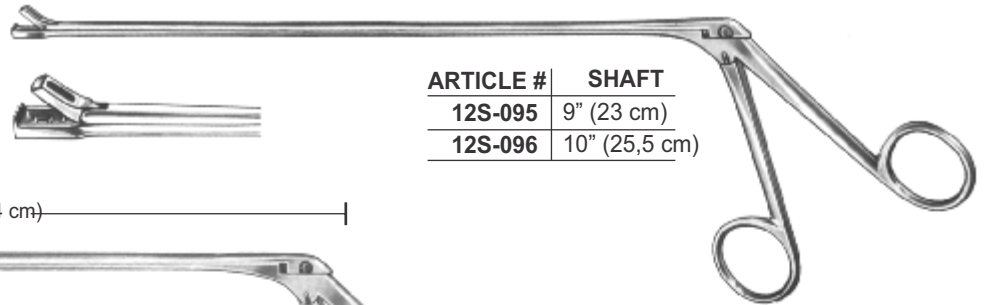

ARTICLE #	SHAFT
12S-095	9" (23 cm)
12S-096	10" (25,5 cm)

Kevorkian Biopsy Forceps

9½" (24 cm)

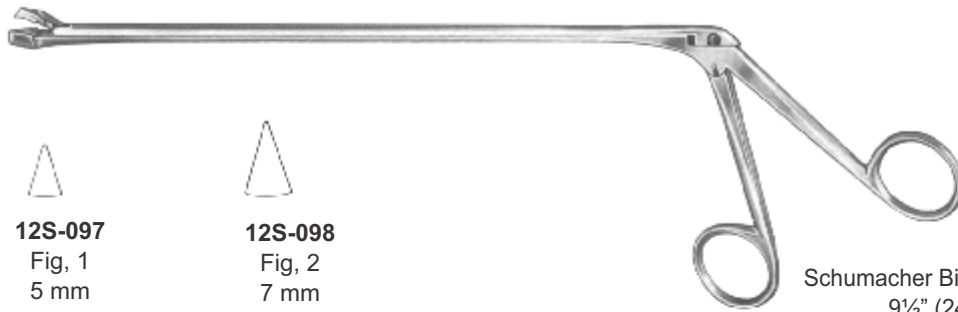

Schumacher Biopsy Forceps  
9½" (24 cm)



12S-097  
Fig, 1  
5 mm



12S-098  
Fig, 2  
7 mm

SHAFT

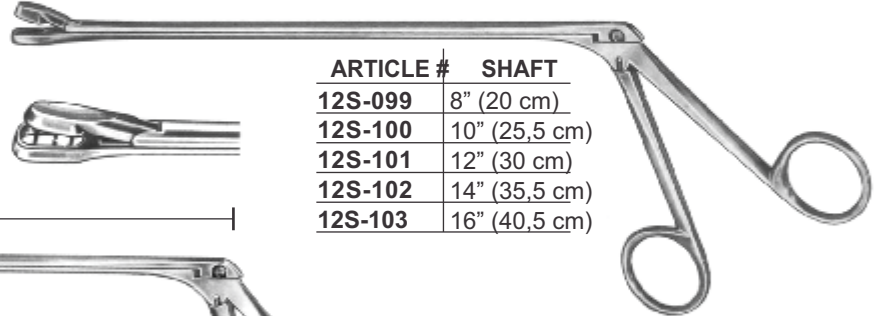

ARTICLE #	SHAFT
12S-099	8" (20 cm)
12S-100	10" (25,5 cm)
12S-101	12" (30 cm)
12S-102	14" (35,5 cm)
12S-103	16" (40,5 cm)

Doyen Biopsy Forceps

9" (23 cm)

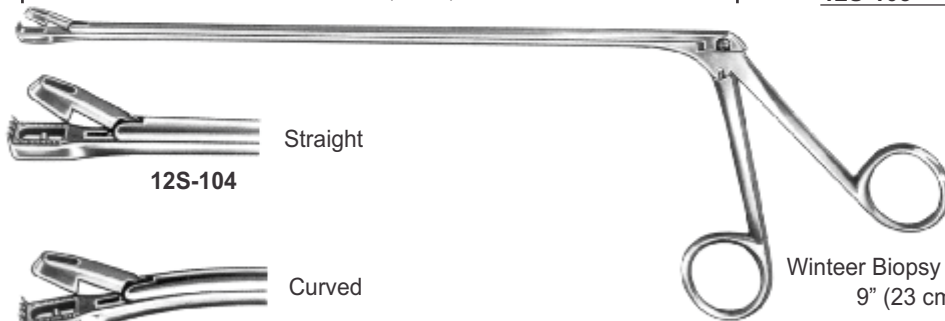

Winteer Biopsy Forceps  
9" (23 cm)



12S-104

Straight

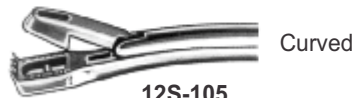

12S-105

Curved

SHAFT

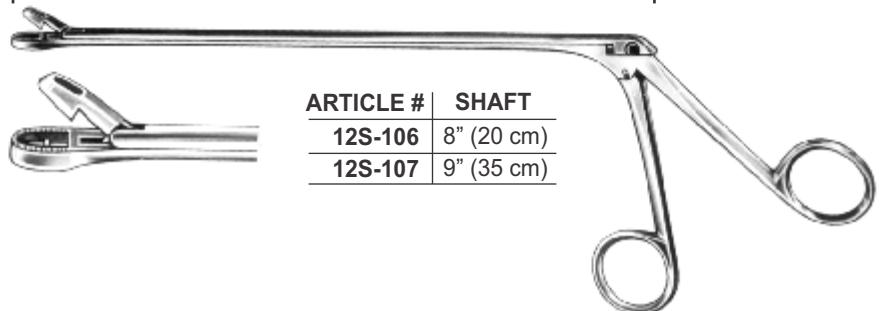

ARTICLE #	SHAFT
12S-106	8" (20 cm)
12S-107	9" (35 cm)

Eppendorf Biopsy Forceps



# GYNACOLOGICAL & OBSTETRICAL INSTRUMENTS

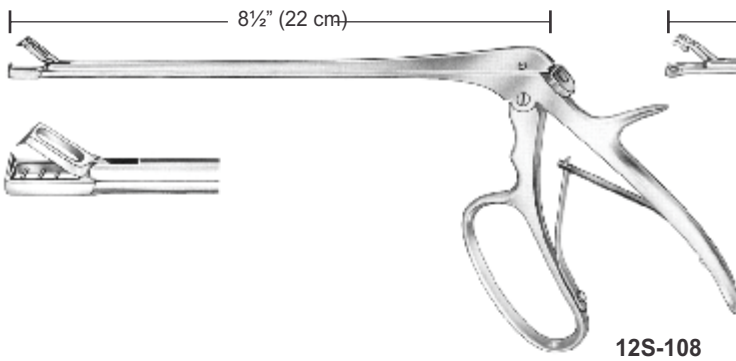
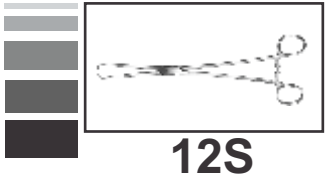

**12S-108**  
Tischler-Kevrokian Biopsy Forceps

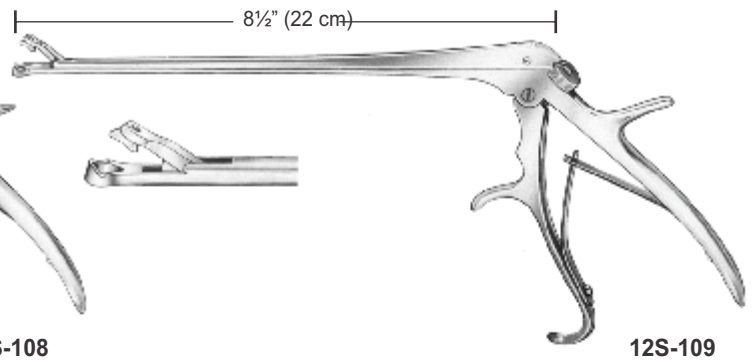

**12S-109**  
Burke Biopsy Forceps

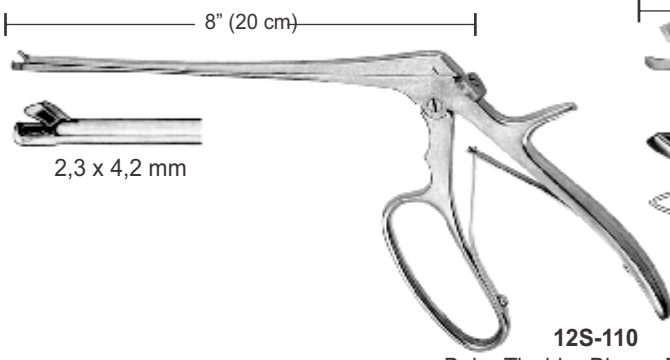

**12S-110**  
Baby-Tischler Biopsy Forceps

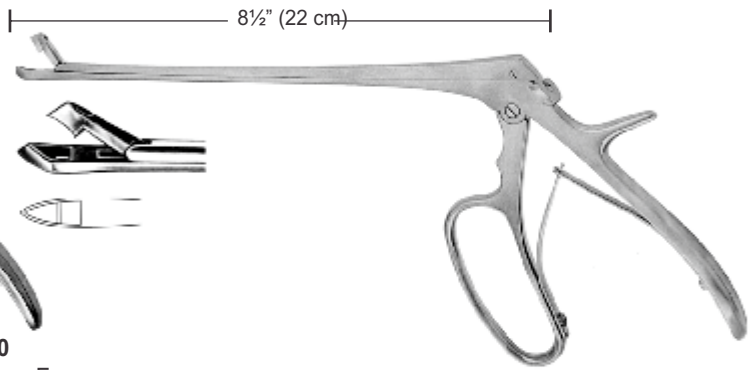

**12S-111**  
Tischler Biopsy Forceps

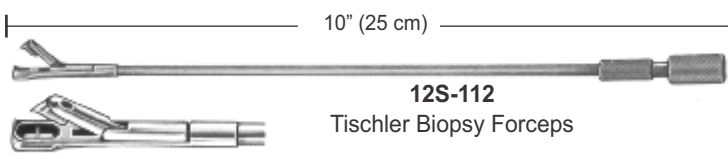

**12S-112**  
Tischler Biopsy Forceps

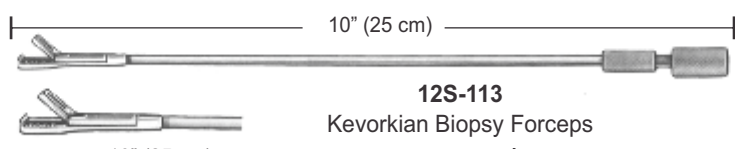

**12S-113**  
Kevorkian Biopsy Forceps

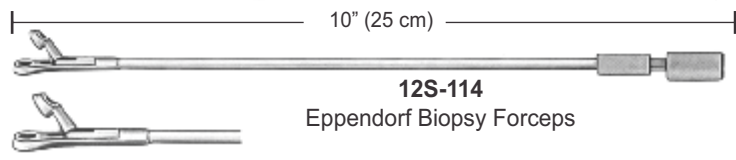

**12S-114**  
Eppendorf Biopsy Forceps

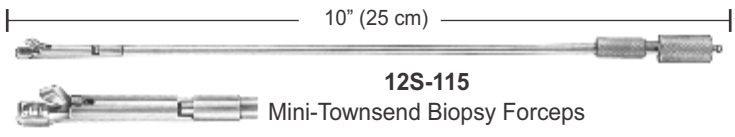

**12S-115**  
Mini-Townsend Biopsy Forceps



**12S-116**  
Handle

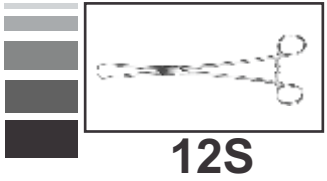

12S

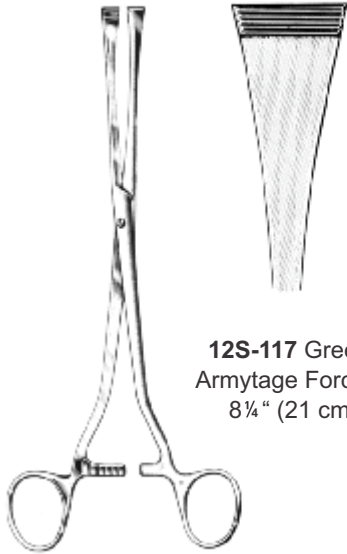

**12S-117** Green-Armytage Forceps  
8 1/4" (21 cm)



**12S-118** Sellhein Forceps  
11" (28 cm)

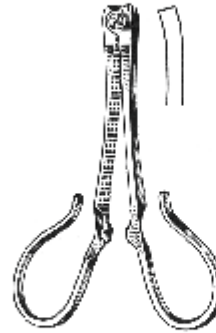

**12S-119** Kane Clamps  
3 1/2" (8,5cm)

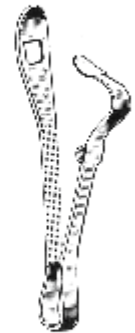

**12S-120** Collin Clamps  
3 1/2" (9 cm)

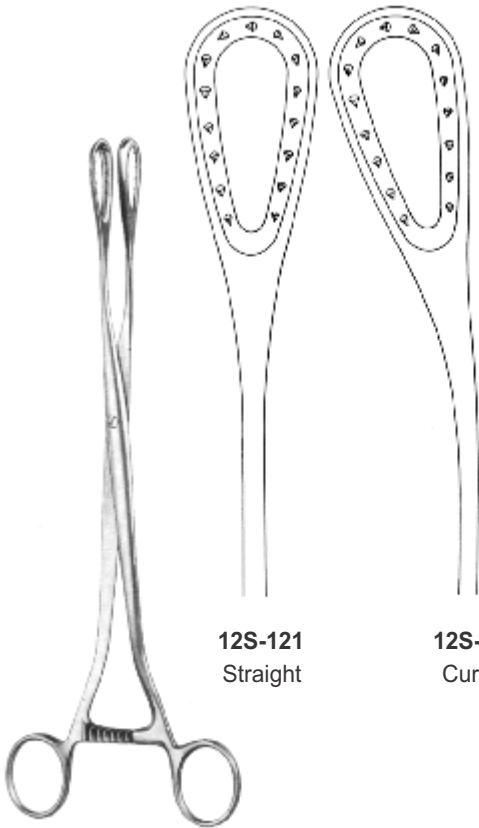

**12S-121** Straight

**12S-122** Curved

Saenger Forceps  
10 1/2" (27 cm)



Winter Forceps  
11" (28 cm)

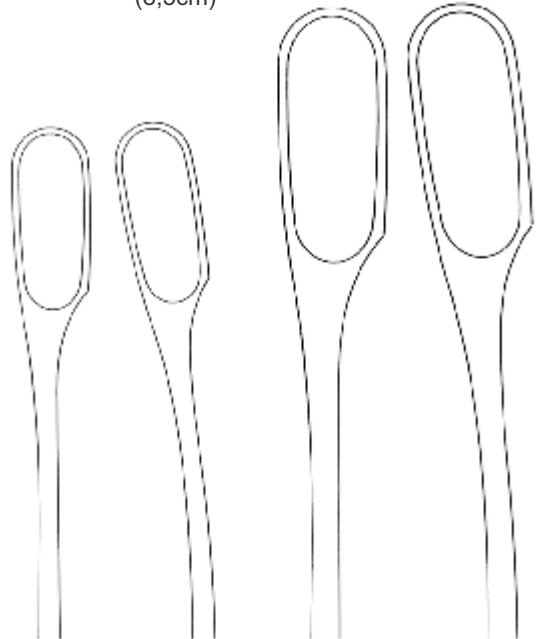

**12S-123** Straight

**12S-124** Curved

**12S-125** Straight

**12S-126** Curved

# GYNACOLOGICAL & OBSTETRICAL INSTRUMENTS

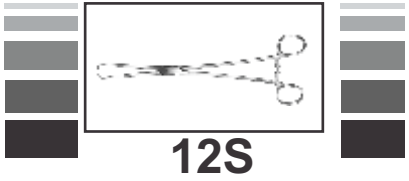

**12S-127**  
Martin  
Pelvineter 13½"  
(34 cm)

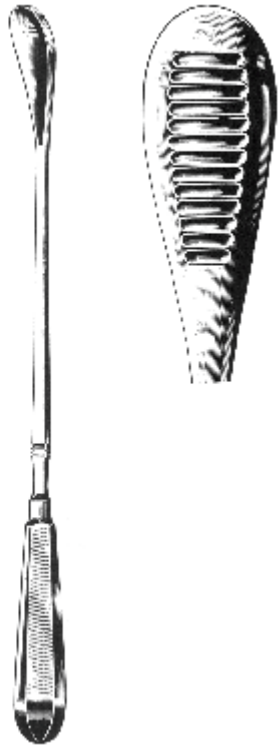

Cuzzi Spoon  
12" (30 cm)

14½mm



**12S-128**

18mm



**12S-129**

20mm

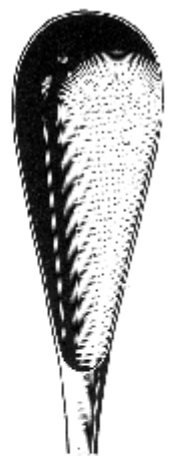

**12S-130**



Naegele Obstetrical Forceps  
**12S-131** | 14" (36 cm)  
**12S-132** | 16" (40 cm)



**12S-133**  
Simpson Obstetrical  
Forceps 12" (30 cm)

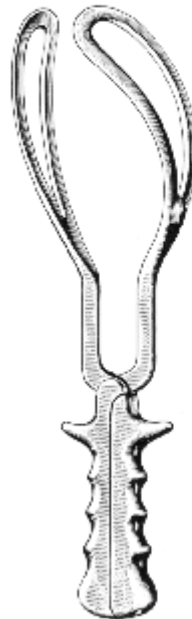

**12S-134**  
Simpson-Braun  
Obstetrical Forceps 14"  
(36 cm)

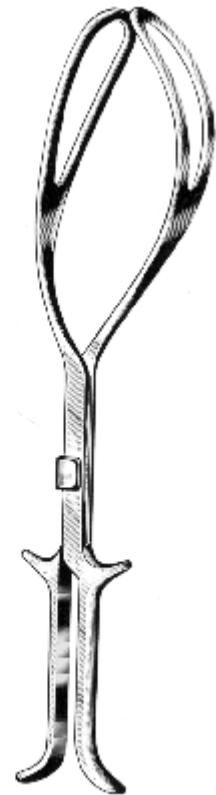

**12S-135**  
Kielland Obstetrical  
Forceps 16" (41 cm)

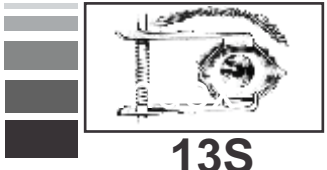

**13S**

# EYE INSTRUMENTS

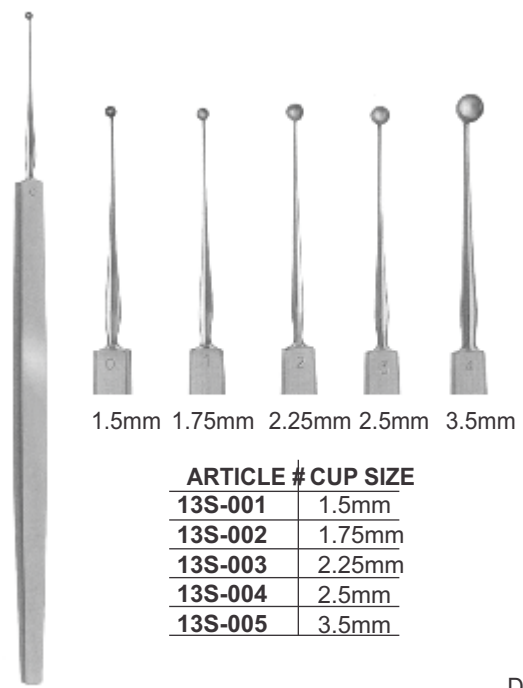

1.5mm 1.75mm 2.25mm 2.5mm 3.5mm

ARTICLE #	CUP SIZE
13S-001	1.5mm
13S-002	1.75mm
13S-003	2.25mm
13S-004	2.5mm
13S-005	3.5mm

Meyerhoefer Curette

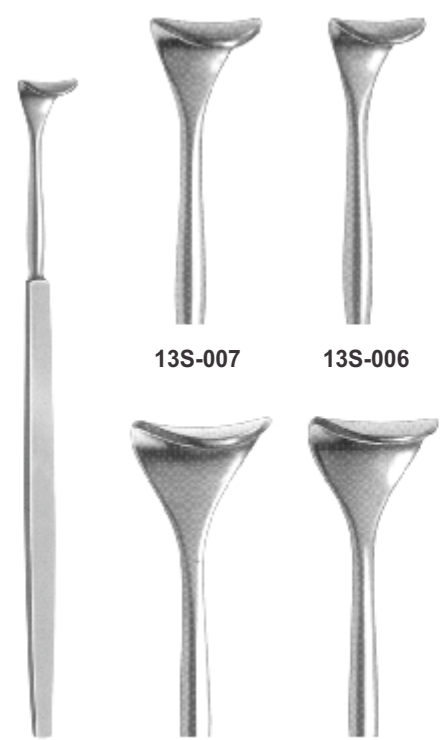

Desmarres Lid Retractor



Graefe Muscle Hook



13S-012 Jameson Muscle Hook small  
13S-013 Jameson Muscle Hook large



13S-014 Kansas Lens Loop



13S-015 Wheeler Spatula 13cm



13S-016 Castroviejo Spatula 0.5mm

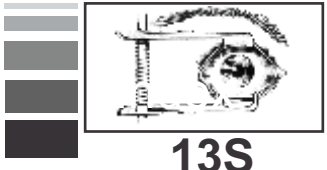

**13S**

# EYE INSTRUMENTS



**13S-017**  
Barraquer Eye Speculum small



**13S-018**  
Barraquer Eye Speculum large

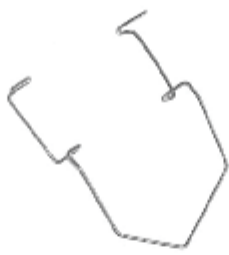

**13S-019**  
Kratz-Barraquer Eye Speculum large

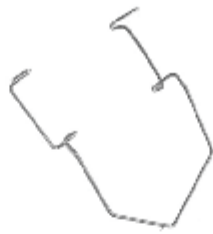

**13S-020**  
Kratz-Barraquer Eye Speculum small



**13S-021**  
Barraquer small



**13S-022**  
Barraquer large



**13S-023**  
Lieberman Eye Speculum, K-wire



**13S-024**  
Lieberman Eye Speculum, V-wire



**13S-025**  
Lieberman Eye Speculum, Pediatric Thin Solid Blade



**13S-026**  
Lieberman Eye Speculum, Pediatric Thin Solid Blade



**13S-026**  
Castroviejo Caliper



**13S-027**  
Curved



**13S-028**  
Angled



**13S-029**  
Straight



**13S-030**  
Stevenson Lacrimal Sac Retractor Solid Blade



**13S-031**  
Stevenson Lacrimal Sac Retractor 3x3 Blunt Prong



**13S-032**  
Jaeger Lid Plate Stainless Steel

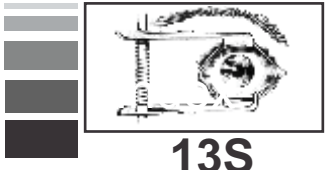

**13S**

# EYE INSTRUMENTS



**13S-033**  
Graefe Iris Forceps 2 3/4" (7 cm)



**13S-034**  
Graefe Iris Forceps 2 3/4" (7 cm)



**13S-035**  
Graefe 1:2 Iris Forceps 2 3/4" (7 cm)



**13S-036**  
Graefe 1:2 Iris Forceps 2 3/4" (7 cm)



**13S-037**



**13S-038**



**13S-039**



**13S-040**



**13S-041**



**13S-042**

Graefe Iris Forceps 4 1/2" (11 cm)



10x  
**13S-043**

(Colibri) Iris Forceps 2 3/4" (7 cm)



10x  
**13S-044**

Troutman (Corneal) Iris Forceps 3" (7.5cm)



10x  
**13S-045**

Troutman (Colibri) Iris Forceps 2 3/4" (7 cm)





# EYE INSTRUMENTS



**13S-046** Bishop-Hartman Forceps  
3½" (8.5cm)



**13S-047** Bishop-Hartman Forceps  
3½" (8.5cm)



**13S-048** Bishop-Hartman Forceps  
3½" (8.5cm)



**13S-049** Bishop-Hartman Forceps  
3½" (8.5cm)



**13S-050** Kirby Forceps  
3½" (9 cm)



**13S-051** Erhardt Chalazion Forceps 3½" (9 cm)

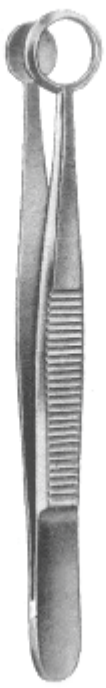

**13S-052** Ayer Chalazion Forceps 3½" (9 cm)



**13S-053** Ayer Chalazion Forceps 3½" (9 cm)

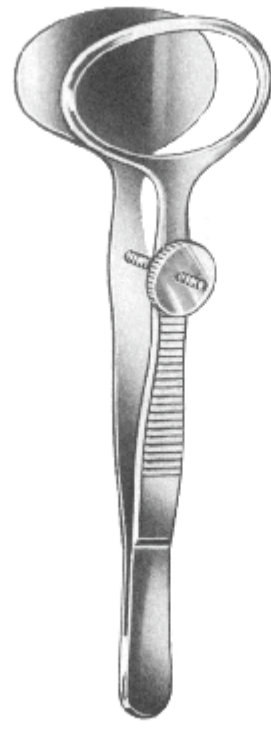

**13S-054 - 13S-056** Desmarres Chalazion Forceps 3½" (9 cm)



**13S-054**

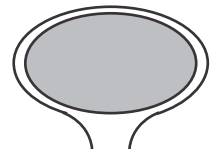

**13S-055**

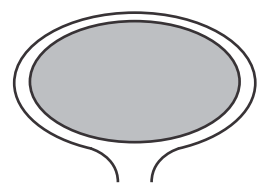

**13S-056**

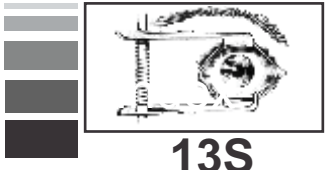

**13S**

# EYE INSTRUMENTS



**13S-057**  
Graefe Fixation  
Forceps 4" (10  
cm)

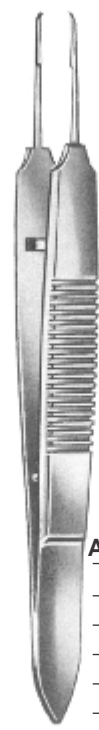

Castroviejo 1:2  
Fixation Forceps  
4" (10 cm)

ARTICLE #	1x2 T Width
<b>13S-058</b>	0.12mm
<b>13S-059</b>	0.30mm
<b>13S-060</b>	0.50mm
<b>13S-061</b>	1.00mm
<b>13S-062</b>	1.50mm

Castroviejo 1:2  
Fixation Forceps  
3½" (9 cm)

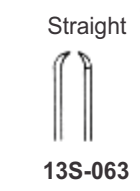

Straight  
**13S-063**



Curved  
**13S-064**



**13S-065**  
Elsching 1:2 Fixation  
Forceps 4½" (11 cm)



**13S-066**  
Paufigue 1:2 Suture  
Forceps 4" (10 cm)



**13S-067**  
Elschnig 2:3  
Fixation Forceps  
4½" (11 cm)



**13S-068**  
Elschnig 3:4  
Fixation Forceps  
4½" (11 cm)



**13S-069**  
Lester Fixation Forceps  
3½" (9 cm)



2:3  
**13S-070**



**13S-071**  
Moorfield Fixation  
Forceps 4" (10 cm)

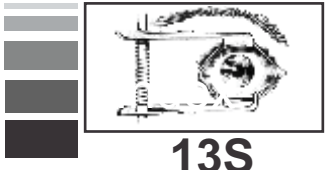

**13S**

**EYE INSTRUMENTS**



13S-072  
13S-073  
13S-074

**13S-072 - 13S-074**  
Noyes Iris Scissors  
4 3/4" (12 cm)



**13S-075**  
Noyes Iris Scissors  
4 3/4" (12 cm)

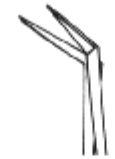
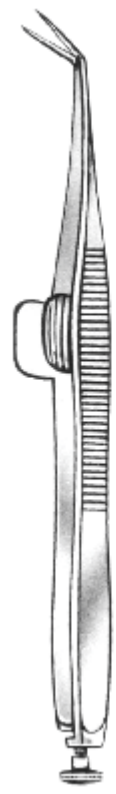

13S-076

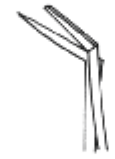

13S-077

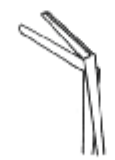

13S-078

**Wecker Scissors**  
4 1/2" (11 cm)



**13S-079 Barraquer Scissors**  
2 1/4" (5.5cm)

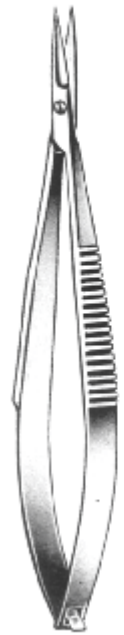

13S-080



13S-081



13S-082



13S-083

**Castroviejo Scissors**  
3 1/2" (9 cm)

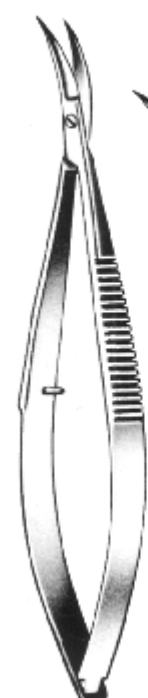

**13S-084**  
Castroviejo Scissors  
4" (10 cm)

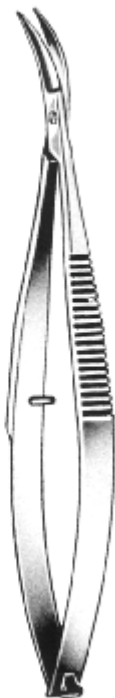

**13S-085**  
Castroviejo Scissors  
4" (10 cm)

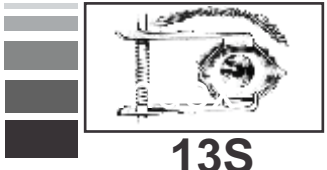

**13S**

# EYE INSTRUMENTS



**13S-086**  
Westcott Tenotomy  
Scissors 4½" (11 cm)



**13S-087**  
Westcott Tenotomy  
Scissors 4½" (11 cm)

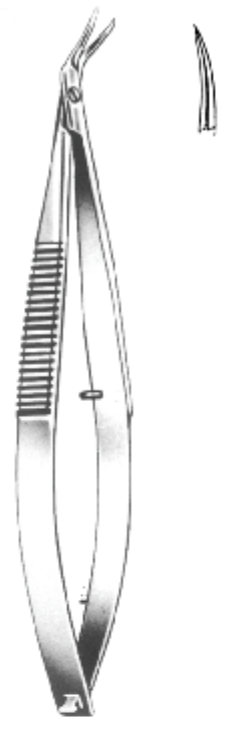

**13S-088**  
Castroviejo Corneal  
Scissors 4" (10 cm)

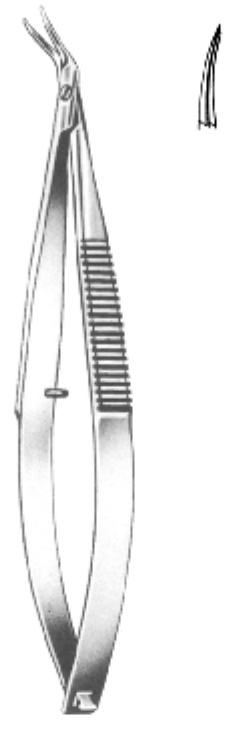

**13S-089**  
Castroviejo Corneal  
Scissors 4" (10 cm)

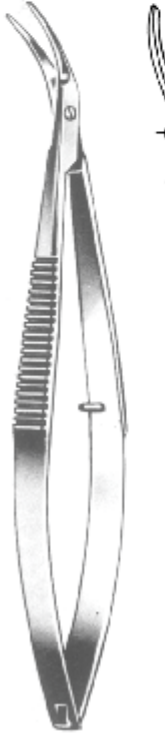
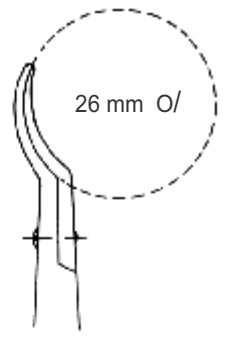

**13S-090**  
Castroviejo Corneal  
Scissors 4½" (11 cm)

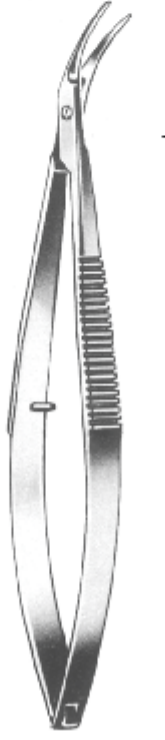

**13S-091**  
Castroviejo Corneal  
Scissors 4½" (11 cm)

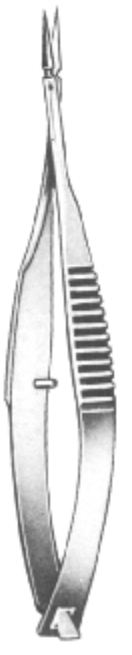

**13S-092**  
Vannas Scissors  
Straight, 3½" (8.5cm)

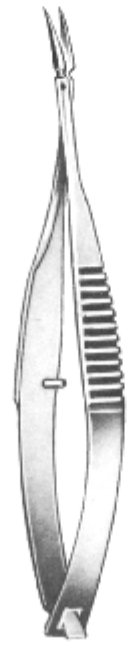

**13S-093**  
Vannas Scissors  
Curved, 3½" (8.5cm)

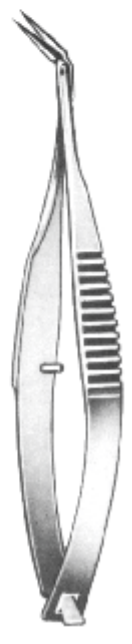

**13S-094**  
Vannas Scissors  
Angled, 3½" (8.5cm)

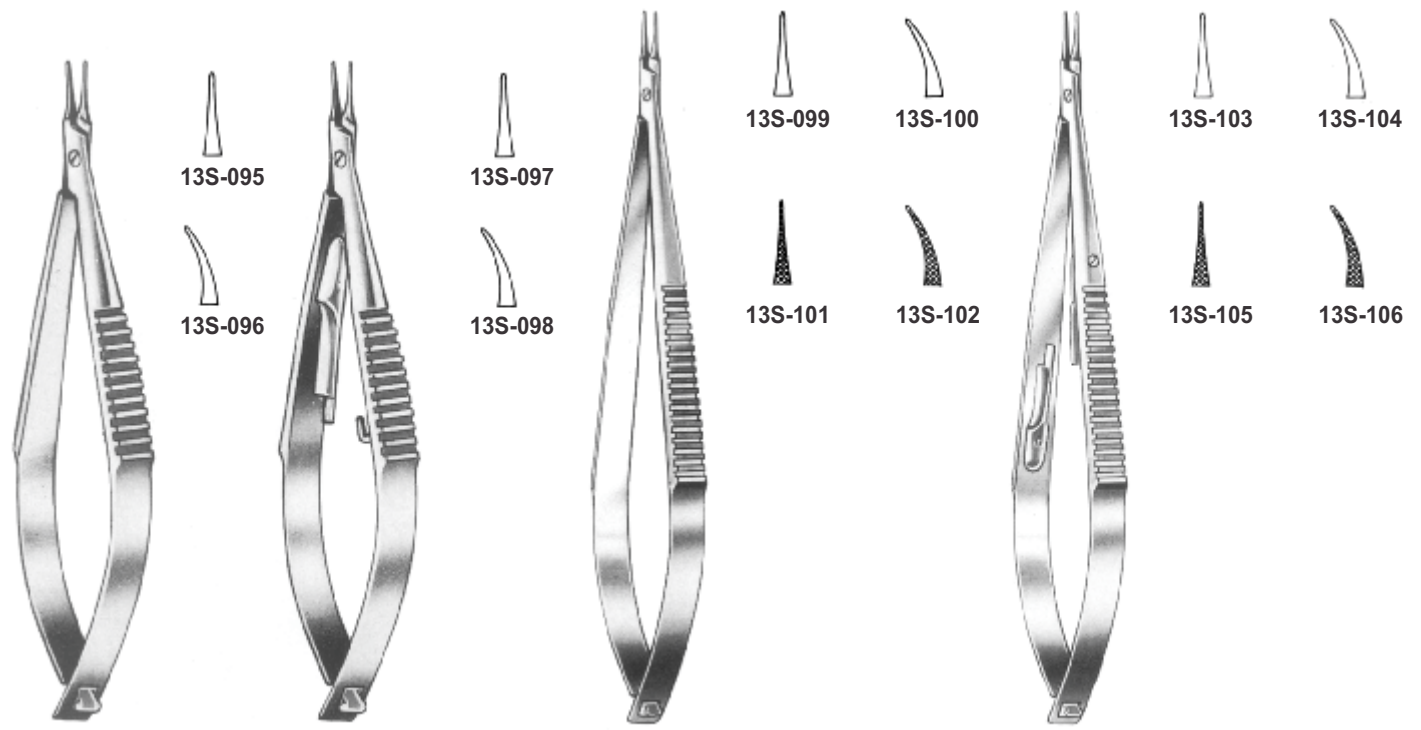

13S-095

13S-096

13S-097

13S-098

13S-099

13S-100

13S-103

13S-104

13S-101

13S-102

13S-105

13S-106

Castroviejo Needle Holders  
3½" (9 cm)

Castroviejo Needle Holders  
3½" (9 cm)

Castroviejo Needle Holders  
5½" (14 cm)

Castroviejo Needle Holders  
5½" (14 cm)

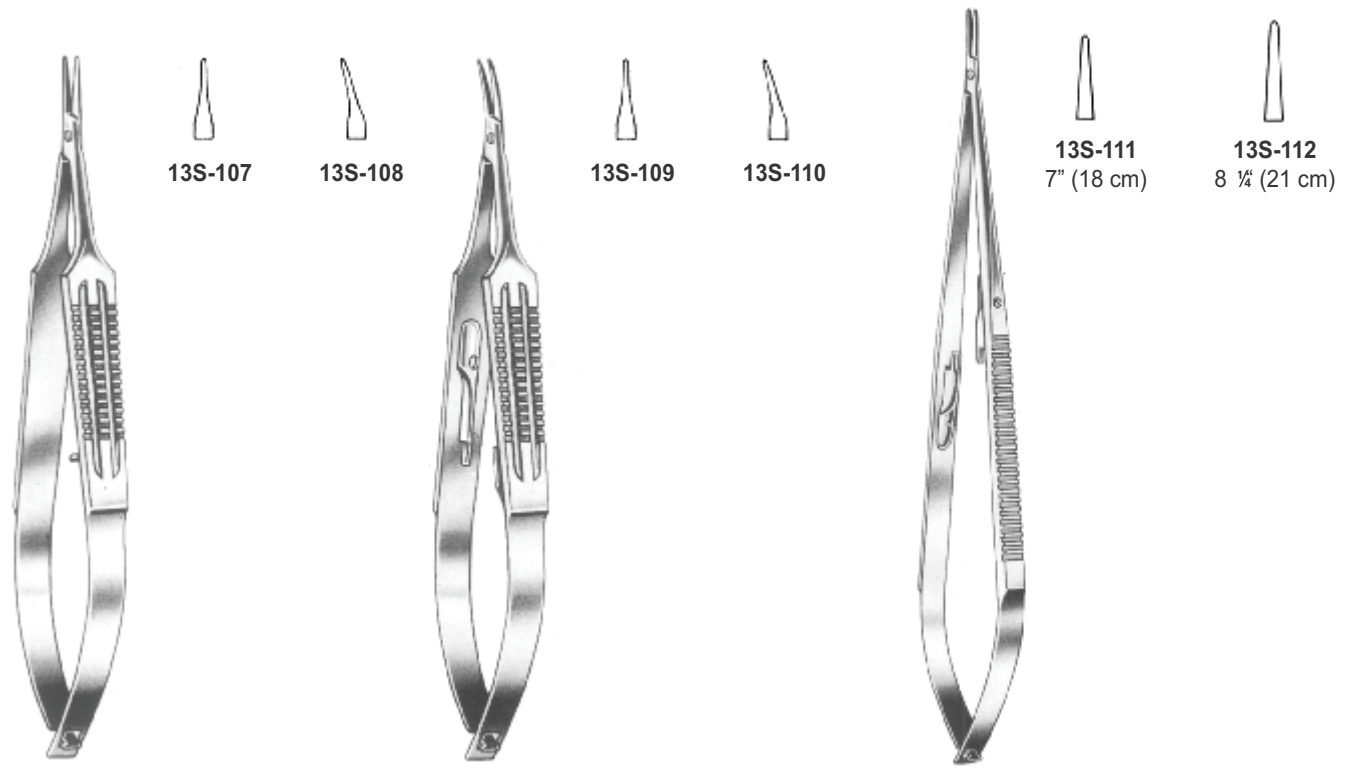

13S-107

13S-108

13S-109

13S-110

13S-111  
7" (18 cm)

13S-112  
8 ¼" (21 cm)

Castroviejo Needle Holders  
5½" (14 cm)

Castroviejo Needle Holders  
5½" (14 cm)

Jacobson Needle Holders



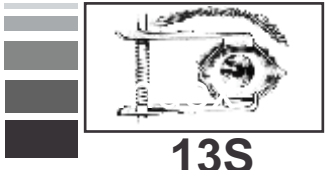

13S

# EYE INSTRUMENTS

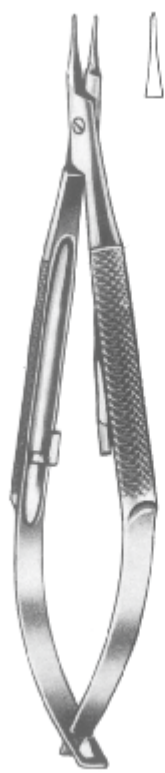

**13S-113**  
Barraquer-Troutman  
Needle  
Holder  
4" (10 cm)

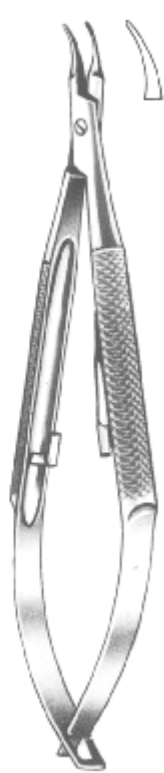

**13S-114**  
Barraquer-Troutman  
Needle  
Holder  
4" (10 cm)



**13S-115**  
Barraquer-Troutman  
Needle  
Holder  
4" (10 cm)



**13S-116**  
Barraquer-Troutman  
Needle  
Holder  
4" (10 cm)



**13S-117**  
Barraquer  
Needle Holder 4  
" (11 cm)



**13S-118**  
Barraquer  
Needle Holder 5"  
(13 cm)



**13S-119**  
Barraquer  
Needle Holder  
5½" (14 cm)

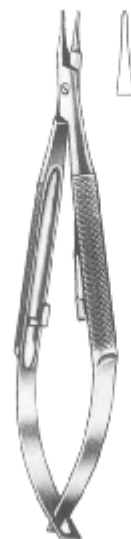

**13S-120**  
Barraquer  
Needle Holder  
5½" (14 cm)



**13S-121**  
Barraquer  
Needle Holder  
5½" (14 cm)



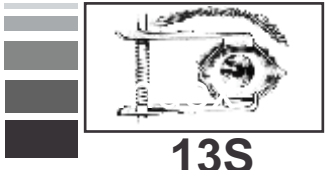

**13S**

# EYE INSTRUMENTS

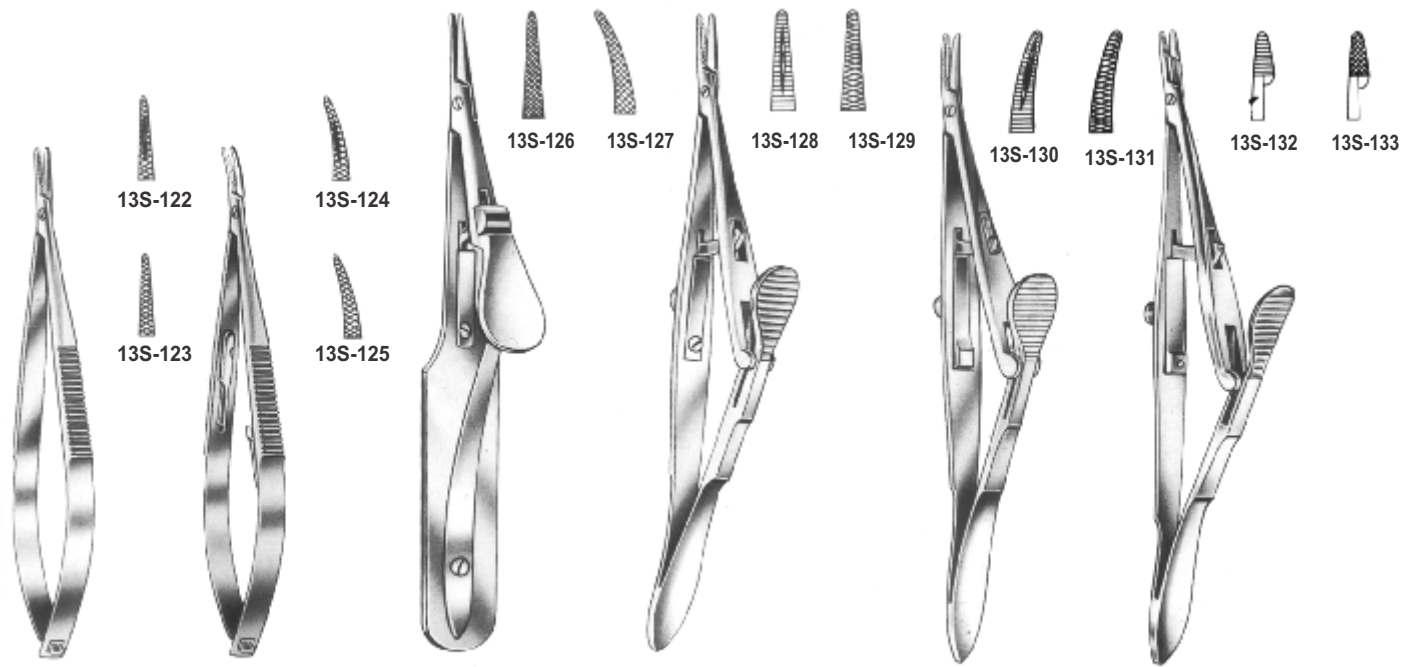

13S-122  
13S-123

13S-124  
13S-125

13S-126

13S-127

13S-128

13S-129

13S-130

13S-131

13S-132

13S-133

Paton Needle Holder 4½" (11 cm) Paton Needle Holder 4½" (11 cm) Arruga Needle Holder 5½" (14 cm) Kalt Needle Holder 5½" (14 cm) Kalt-Arruga Needle Holder 5½" (14 cm) Castroviejo-Kalt Needle Holder 5 ¼" (13.5cm)

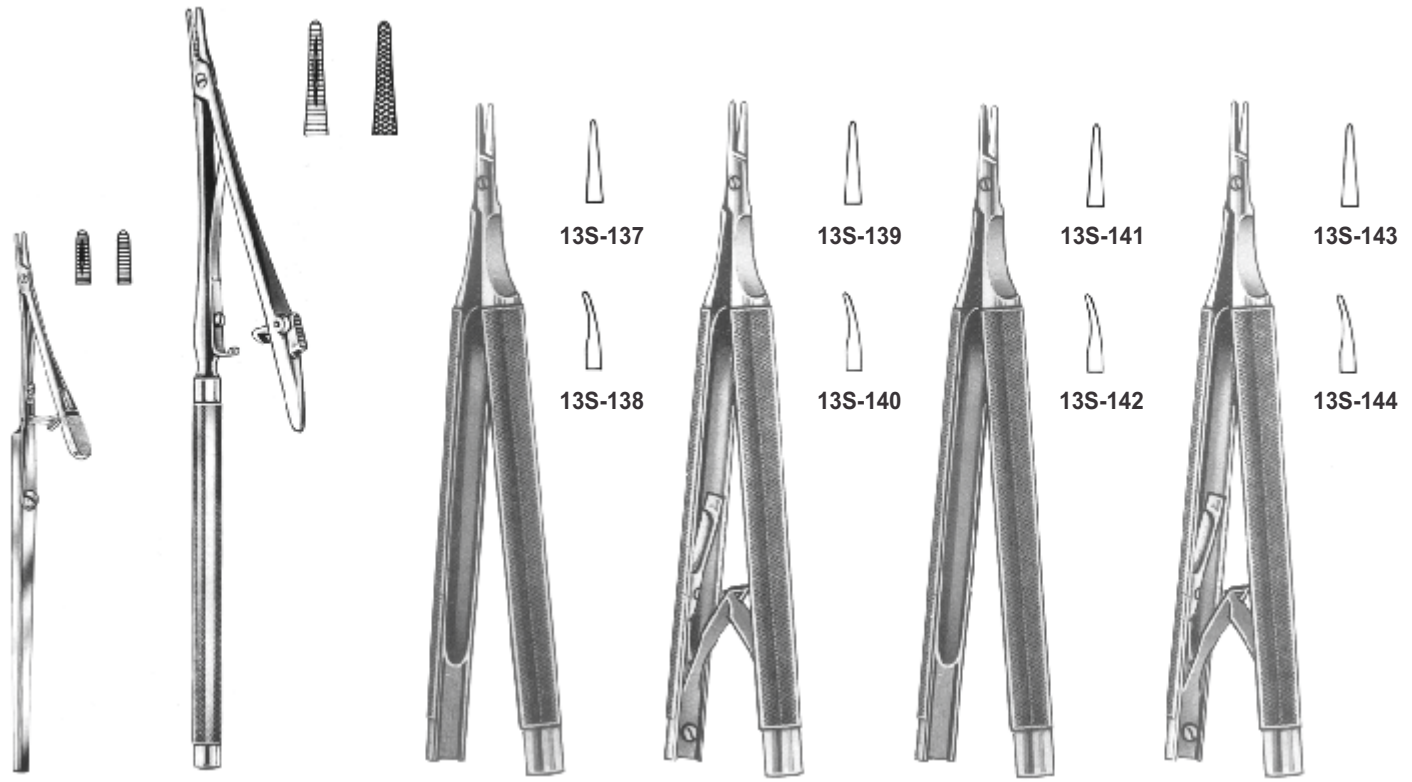

13S-137

13S-139

13S-141

13S-143

13S-138

13S-140

13S-142

13S-144

Stevens Needle Holder  
**ARTICLE # | SIZE**  
 13S-134 | 5" (13 cm)  
 13S-135 | 6" (15 cm)

13S-136 Potts-Smith Needle Holder 8 ¾" (22 cm)

Castroviejo Blade Breaker 5 ¼" (13 cm) Castroviejo Blade Breaker 5 ¼" (13 cm) Castroviejo Blade Breaker 5 ¼" (13 cm) Castroviejo Blade Breaker 5 ¼" (13 cm)

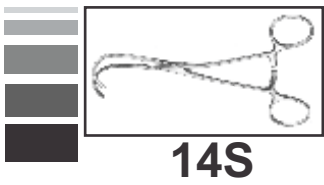

# ATRAUMATIC INSTRUMENTS

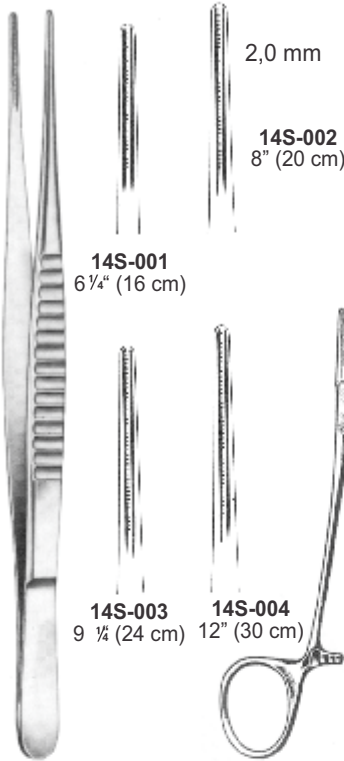

De-Bakey  
Atrauma Dressing Forceps

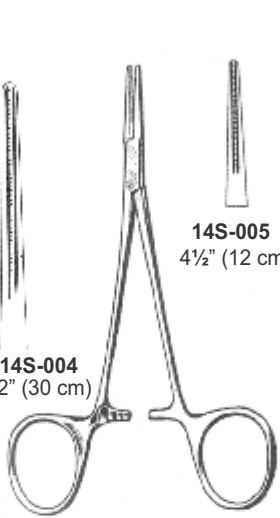

De-Bakey-Mosquito

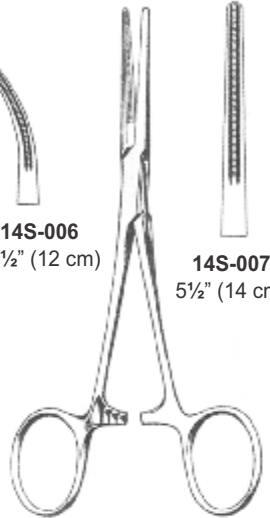

De-Bakey-Kelly

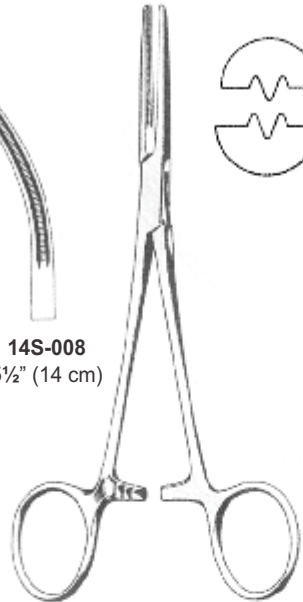

De-Bakey-Rankin

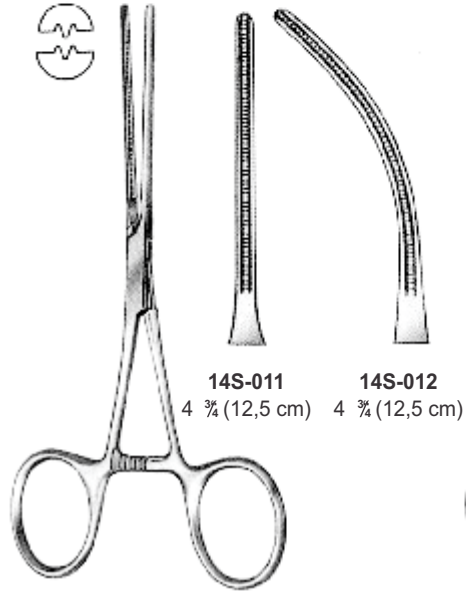

De-Bakey-Atraumatic Vascular Clamps

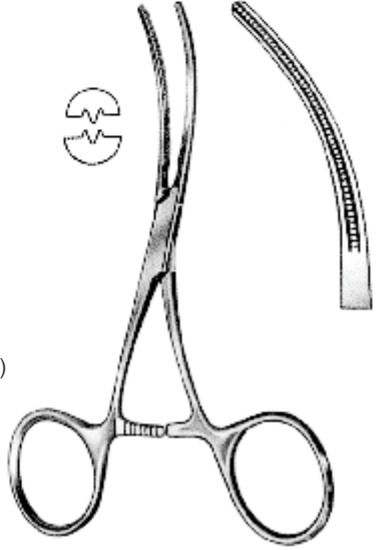

De-Bakey-Atraumatic Vascular  
Clamps 4 3/4" (12,5 cm)

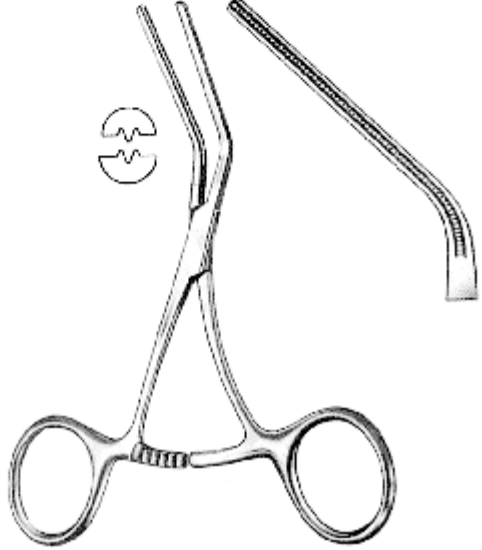

De-Bakey-Atraumatic Vascular  
Clamps 4 3/4" (12,5 cm)

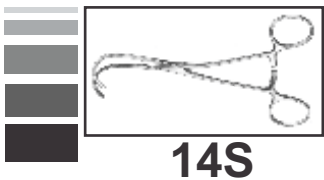

# ATRAUMATIC INSTRUMENTS

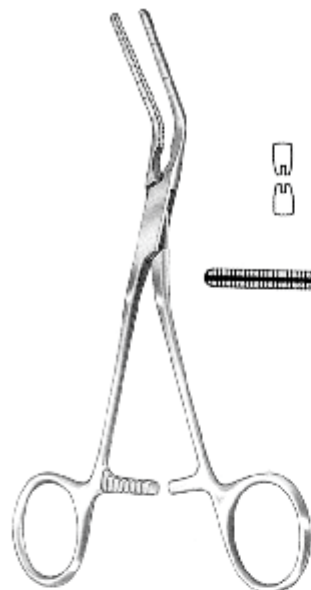

Cooley  
Atraumatic Vascular Clamps

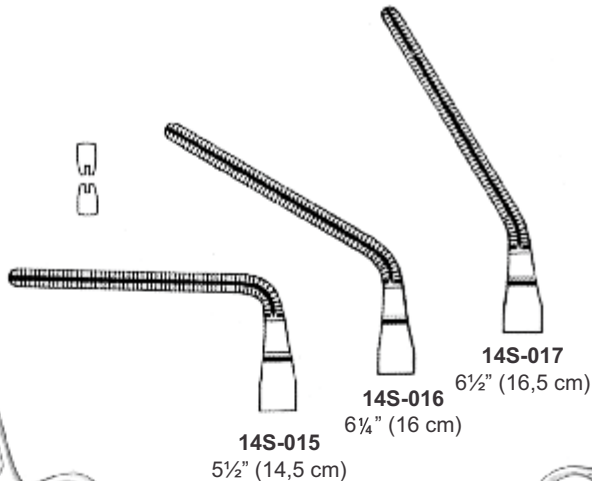

14S-015  
5½" (14,5 cm)

14S-016  
6¼" (16 cm)

14S-017  
6½" (16,5 cm)

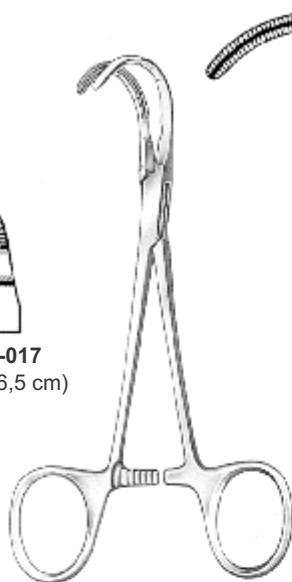

Cooley-Beck  
Atraumatic Vascular Clamps

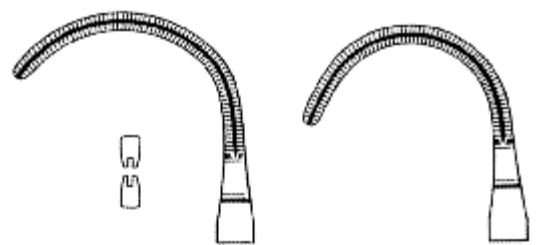

14S-018  
6½" (16,5 cm)

14S-019  
6" (15 cm)

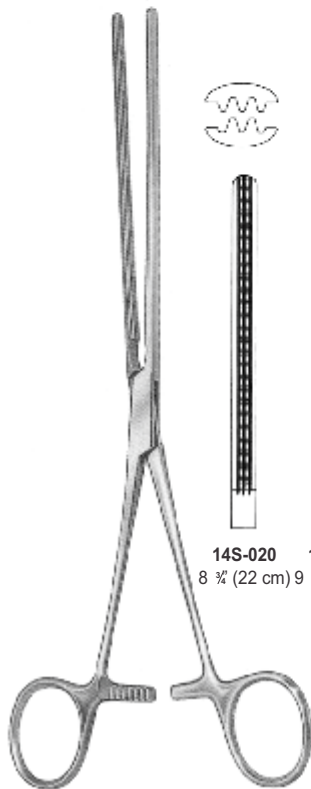

De-Bakey  
Atraumatic Intestinal Clamps

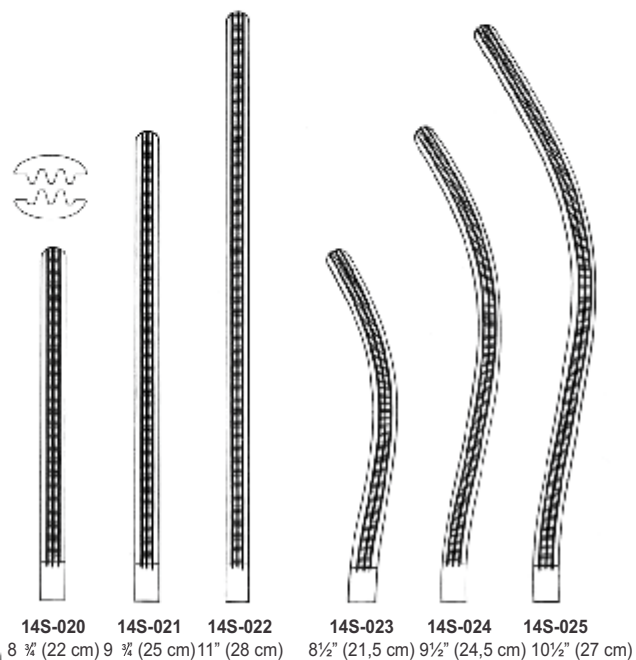

14S-020 8 ¾" (22 cm) 14S-021 9" (25 cm) 14S-022 11" (28 cm)

14S-023 8½" (21,5 cm) 14S-024 9½" (24,5 cm) 14S-025 10½" (27 cm)

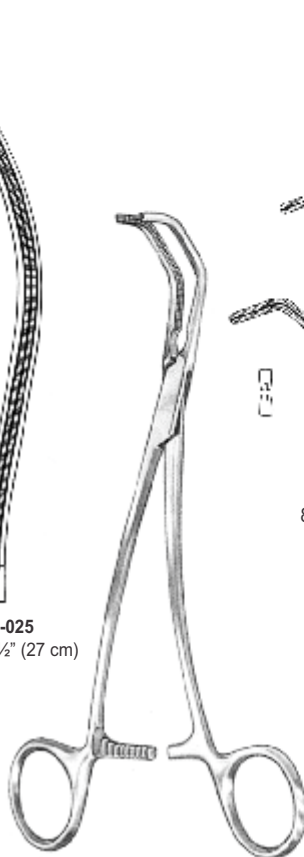

Cooley  
Atraumatic Vascular Clamps

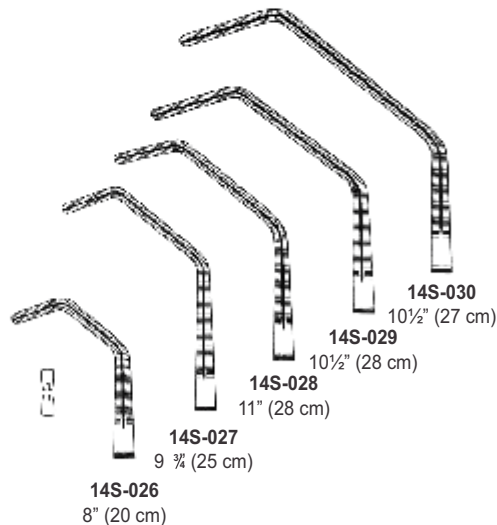

14S-026  
8" (20 cm)

14S-027  
9 ¾" (25 cm)

14S-028  
11" (28 cm)

14S-029  
10½" (28 cm)

14S-030  
10½" (27 cm)

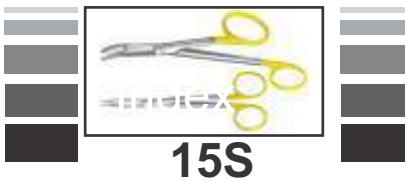

**TUNGSTEN CARBIDE INSTRUMENTS  
(T.C)**

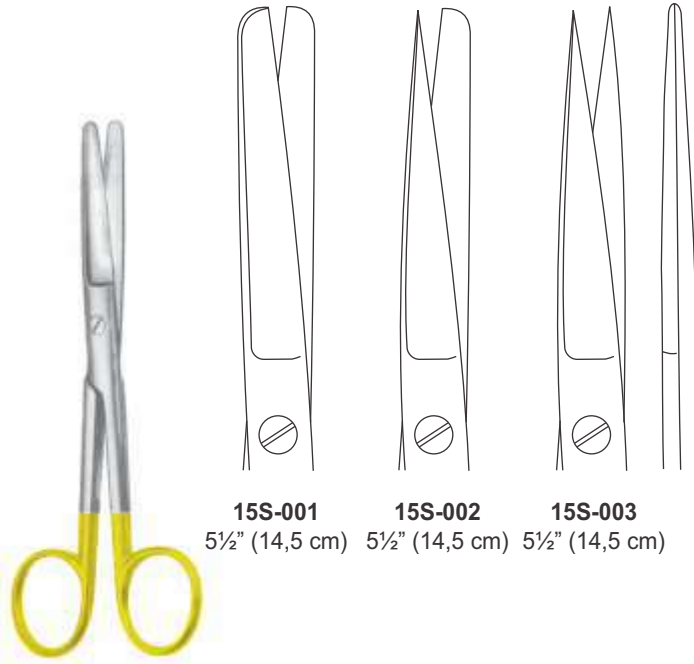

**15S-001** 5½" (14,5 cm)  
**15S-002** 5½" (14,5 cm)  
**15S-003** 5½" (14,5 cm)

Dressing Scissors, Straight T.C



**15S-004** 5½" (14,5 cm)  
**15S-005** 5½" (14,5 cm)  
**15S-006** 5½" (14,5 cm)

Dressing Scissors, Curved T.C

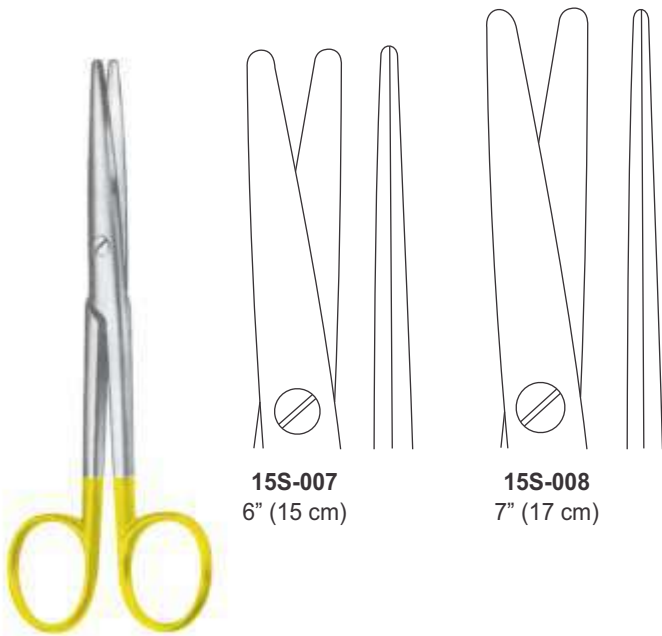

**15S-007** 6" (15 cm)  
**15S-008** 7" (17 cm)

Mayo Stille Scissors, Straight T.C



**15S-009** 6" (15 cm)  
**15S-010** 7" (17 cm)

Mayo Stille Scissors, Curved T.C



15S

# TUNGSTEN CARBIDE INSTRUMENTS (T.C)



Mayo Scissors, Straight T.C

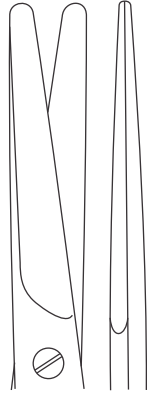

**15S-011**  
5½" (14 cm)

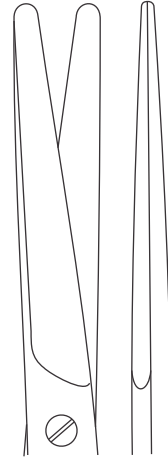

**15S-012**  
7" (17 cm)

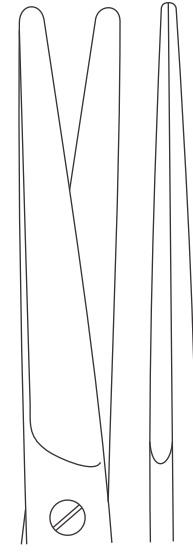

**15S-013**  
9" (23 cm)



Mayo Scissors, Curved T.C



**15S-014**  
5½" (14 cm)



**15S-015**  
7" (17 cm)

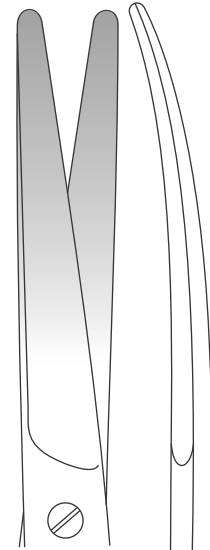

**15S-016**  
9" (23 cm)



15S

# TUNGSTEN CARBIDE INSTRUMENTS (T.C)



Metzenbaum Scissors  
Straight T.C



**15S-017**  
5½" (14 cm)



**15S-018**  
7" (18 cm)



**15S-019**  
8" (20 cm)



**15S-020**  
9" (23 cm)



**15S-021**  
10" (25 cm)



**15S-022**  
11" (28 cm)



**15S-023**  
12" (30 cm)

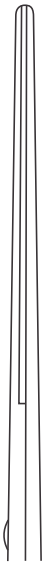

Metzenbaum Scissors  
Curved T.C



**15S-024**  
5½" (14 cm)



**15S-025**  
7" (18 cm)



**15S-026**  
8" (20 cm)



**15S-027**  
9" (23 cm)



**15S-028**  
10" (25 cm)



**15S-029**  
11" (28 cm)



**15S-030**  
12" (30 cm)







15S

# TUNGSTEN CARBIDE INSTRUMENTS (T.C)



Metzenbaum Scissors  
Straight T.C



**15S-017**  
5½" (14 cm)



**15S-018**  
7" (18 cm)



**15S-019**  
8" (20 cm)



**15S-020**  
9" (23 cm)



**15S-021**  
10" (25 cm)



**15S-022**  
11" (28 cm)

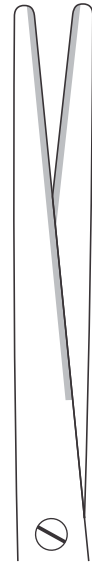

**15S-023**  
12" (30 cm)

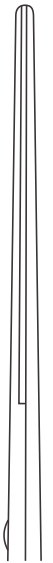

Metzenbaum Scissors  
Curved T.C



**15S-024**  
5½" (14 cm)



**15S-025**  
7" (18 cm)



**15S-026**  
8" (20 cm)



**15S-027**  
9" (23 cm)



**15S-028**  
10" (25 cm)



**15S-029**  
11" (28 cm)



**15S-030**  
12" (30 cm)





15S

**TUNGSTEN CARBIDE INSTRUMENTS  
(T.C)**

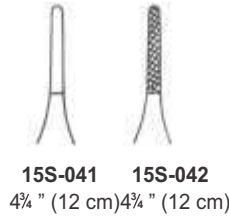

Adson Forceps T.C



ARTICLE #	LENGTH
15S-043	4 3/4" (12 cm)
15S-044	6" (15 cm)

Adson-Brown T.C

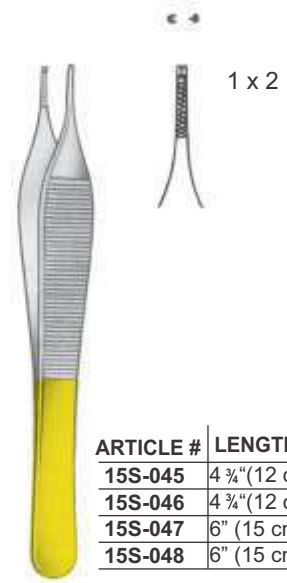

ARTICLE #	LENGTH	JAW
15S-045	4 3/4" (12 cm)	1,7 mm
15S-046	4 3/4" (12 cm)	1,0 mm
15S-047	6" (15 cm)	1,7 mm
15S-048	6" (15 cm)	1,0 mm

Micro-Adson T.C



Wangenstein Forceps T.C

ARTICLE #	LENGTH
15S-049	6" (15 cm)
15S-050	9" (23 cm)
15S-051	9 3/4" (25 cm)



15S-052  
McIndoe Forceps  
T.C 6" (15 cm)



Bayonet Forceps T.C

ARTICLE #	LENGTH
15S-053	5 1/2" (14 cm)
15S-054	6 1/2" (16 cm)

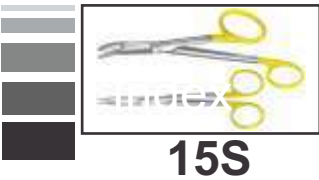

# TUNGSTEN CARBIDE INSTRUMENTS (T.C)



1,8 mm 2,7 mm

ARTICLE #	LENGTH	JAW
15S-055	5½" (14,5 cm)	1,8 mm
15S-056	6½" (16 cm)	1,8 mm
15S-057	7" (18 cm)	1,8 mm
15S-058	8" (20 cm)	1,8 mm
15S-059	9" (23 cm)	1,8 mm
15S-060	10" (25 cm)	1,8 mm
15S-061	5½" (14,5 cm)	2,7 mm
15S-062	6½" (16 cm)	2,7 mm
15S-063	7" (18 cm)	2,7 mm
15S-064	8" (20 cm)	2,7 mm
15S-065	9" (23 cm)	2,7 mm

Dressing Forceps T.C



1,8 mm

With Dissector:

ARTICLE #	LENGTH
15S-066	7" (18 cm)
15S-067	8 ¼" (21 cm)
15S-068	9" (23cm)
15S-069	10" (25 cm)

Potts-Smith Dressing Forceps T.C

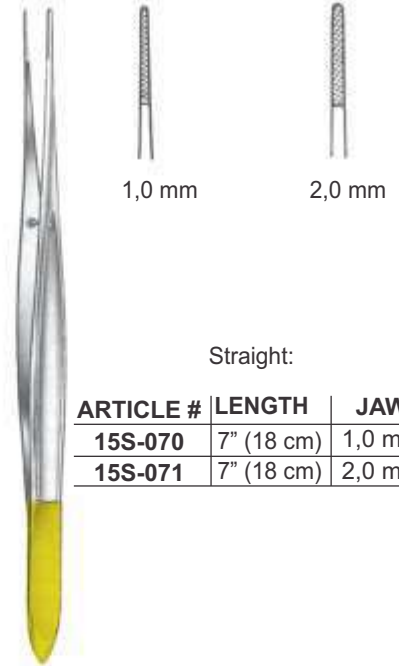

1,0 mm 2,0 mm

Straight:

ARTICLE #	LENGTH	JAW
15S-070	7" (18 cm)	1,0 mm
15S-071	7" (18 cm)	2,0 mm

Cushing Dressing Forceps T.C



1 x 2

Ⓐ Standard:

ARTICLE #	LENGTH
15S-072	5½" (14,5 cm)
15S-073	6½" (16 cm)
15S-074	7" (18 cm)
15S-075	8" (20 cm)
15S-076	10" (25 cm)

Ⓑ Delicate:

ARTICLE #	LENGTH
15S-077	5½" (14,5 cm)
15S-078	6½" (16 cm)
15S-079	7" (18 cm)
15S-080	8" (20 cm)
15S-081	10" (25 cm)

Oehler Tissue Forceps T.C



1 x 2

15S-082 Bonney Tissue Forceps T.C 6¾" (17 cm)

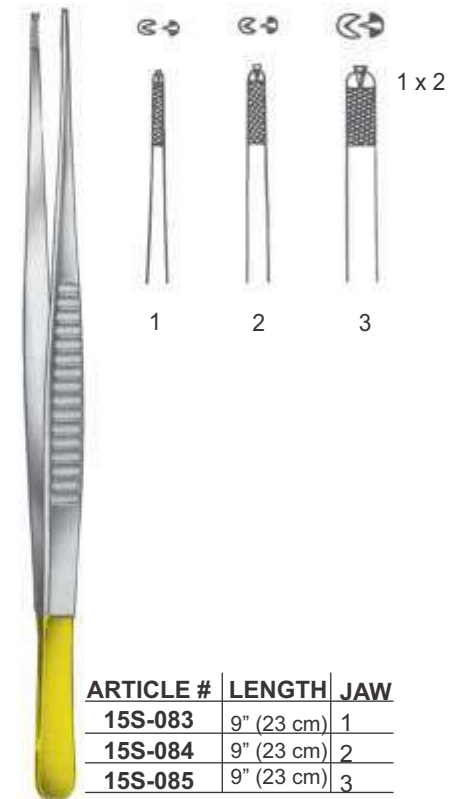

1 2 3

1 x 2

ARTICLE #	LENGTH	JAW
15S-083	9" (23 cm)	1
15S-084	9" (23 cm)	2
15S-085	9" (23 cm)	3

Skinner Tissue Forceps T.C

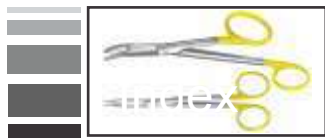

15S

TUNGSTEN CARBIDE INSTRUMENTS  
(T.C)



**15S-086**  
Williams Tissue Forceps  
T.C 8" (20 cm)



**15S-087**  
Mod. USA, Dressing  
Forceps T.C 8" (15 cm)



**15S-088**  
Gillies Tissue Forceps T.C  
6" (15 cm)



**15S-089**  
Gerald Dressing  
Forceps T.C 7" (18 cm)



**15S-090**  
Gerald Tissue Forceps  
T.C 7" (18 cm)



**15S-091**  
Evans Tissue Forceps T.C  
9 3/4" (25 cm)

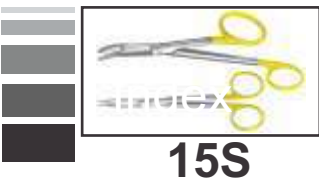

# TUNGSTEN CARBIDE INSTRUMENTS (T.C)



**15S-092**  
Derf Needle Holder  
T.C 4 3/4" (12 cm)



**15S-093**  
Halsey Needle Holder T.C

**15S-094**  
5" (13 cm)



**15S-095**  
Webster Needle  
Holder T.C 5" (13 cm)



**15S-096**  
Hegar-Baumgartner  
Needle Holder T.C

**15S-097**  
5" (13 cm) 5 1/2" (14 cm)



**15S-102**  
Mayo-Hegar Needle Holder T.C

**15S-098** 5 1/2" (14 cm) **15S-099** 6 1/4" (16 cm) **15S-100** 7" (18 cm) **15S-101** 8" (20 cm)

**15S-102** 9 1/2" (24 cm) **15S-103** 10" (26 cm) **15S-104** 12" (30 cm)



**15S-109**  
Crile-Wood Needle Holder T.C

**15S-105** 6" (15 cm) **15S-106** 7" (18 cm) **15S-107** 8" (20 cm) **15S-108** 9" (23 cm)

**15S-109** 10" (26 cm) **15S-110** 12" (30 cm)



**15S-114**  
De-Bakey Needle Holder T.C

**15S-111** 7" (18 cm) **15S-112** 8" (20 cm) **15S-113** 9" (23 cm)

**15S-114** 10" (26 cm) **15S-115** 12" (30 cm)

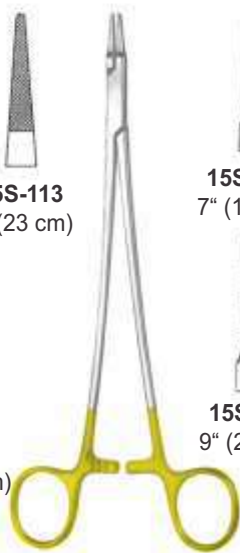

**15S-118**  
Intracardiac Needle Holder T.C

**15S-116** 7" (18 cm) **15S-117** 8" (20 cm)

**15S-118** 9" (23 cm) **15S-119** 10" (26 cm)

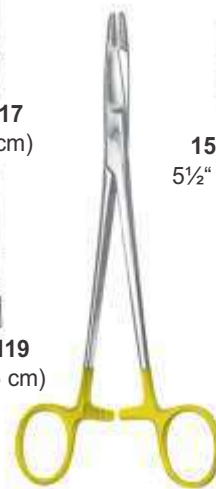

**15S-120**  
Olsen-Hegar Needle Holder T.C

**15S-120** 5 1/2" (14 cm) **15S-121** 6 1/2" (16,5 cm) **15S-122** 7" (18 cm)

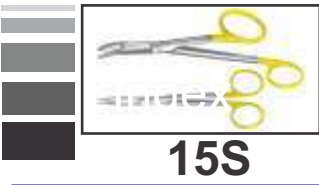

**TUNGSTEN CARBIDE INSTRUMENTS  
(T.C)**

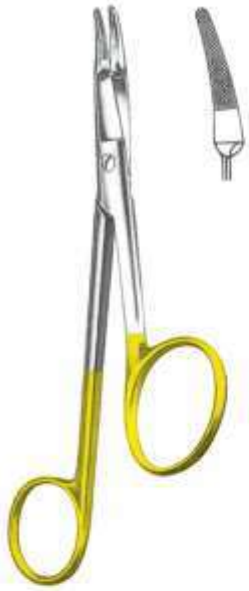

**15S-123**  
Gillies Needle Holder  
T.C 6½" (16 cm)



**15S-124**  
Swedish Needle Holder  
T.C 5½" (14,5 cm)



**15S-125**  
Neivert Needle Holder  
T.C 5" (13 cm)



**15S-126**  
Tonnies Needle Holder  
T.C 7½" (19 cm)



**15S-127**  
5½" (14 cm)



**15S-128**  
6 ¾" (17 cm)



**15S-129**  
8" (20 cm)



**15S-130**  
6 ¾" (17 cm)



**15S-131**  
8" (20 cm)



**15S-132**  
9" (23 cm)



**15S-133**  
Zweifel Needle  
Holder T.C 8" (20 cm)

Mathieu Needle Holder T.C

Mathieu Needle Holder T.C





**15S**

# TUNGSTEN CARBIDE INSTRUMENTS (T.C)



**15S-134**  
5½" (14 cm)



**15S-136**  
5½" (14 cm)



**15S-135**  
5½" (14 cm)



**15S-137**  
5½" (14 cm)



**15S-138**  
7" (18 cm)



**15S-139**  
7" (18 cm)



**15S-140**  
7" (18 cm)



**15S-141**  
7" (18 cm)



**15S-142**  
Kalt Needle Holder T.C  
5¼" (13,5 cm)

Castroviejo  
Needle Holder T.C

Castroviejo  
Needle Holder T.C

Castroviejo  
Needle Holder T.C

Castroviejo  
Needle Holder T.C



**15S-147**  
6 ¼" (16 cm)



**15S-148**  
7" (18 cm)



**15S-145**  
8 ¼" (21 cm)



**15S-146**  
8 ¼" (21 cm)



**15S-149**  
8" (20 cm)



**15S-150**  
9" (23 cm)



**15S-151**  
10 ¼" (26 cm)



**15S-143**  
Castroviejo Blade  
Breaker 5¼" (13 cm)



**15S-144**  
Potts-Smith Blade  
Breaker 8 ¾" (22 cm)



Jacobson Needle Holder T.C

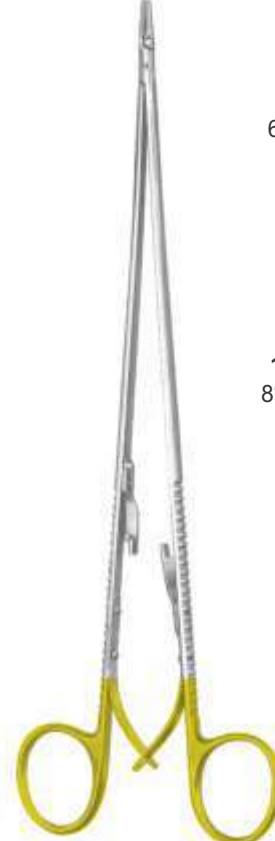

Diethrich Needle Holder T.C

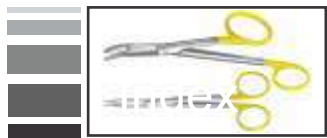

15S

**TUNGSTEN CARBIDE INSTRUMENTS  
(T.C)**

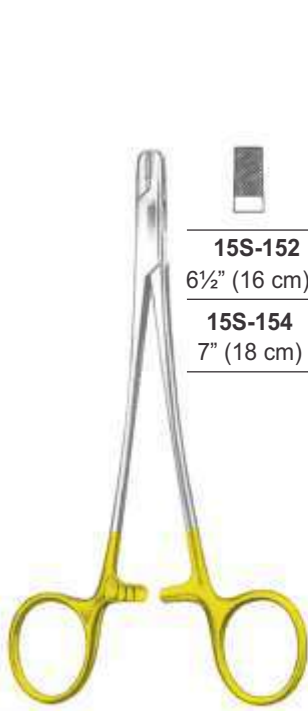

Wire Twisting Forceps

<b>15S-152</b> 6½" (16 cm)	<b>15S-153</b> 6½" (16 cm)
<b>15S-154</b> 7" (18 cm)	<b>15S-155</b> 7" (18 cm)



**15S-156**  
Wire Holding  
Plier 7" (18 cm)



Flat Nose Plier  
7" (18 cm)



15S-157



15S-158

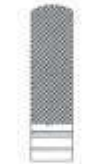

15S-159



**15S-160**  
Wire Cutting Plier  
5½" (14 cm)



**15S-161**  
Mini Wire  
Cutting Plier  
6½" (16 cm)



**15S-162**  
Cotting Plier Front and  
Side Cutter 7" (18 cm)



Front View



Side View



**15S-163**  
Wire Cutting Plier  
9" (23 cm)



**15S-164**  
Bone Plate Cutter  
9½" (24 cm)



# LASER SURGERY INSTRUMENTS



Available in Black & Blue Laser Coating

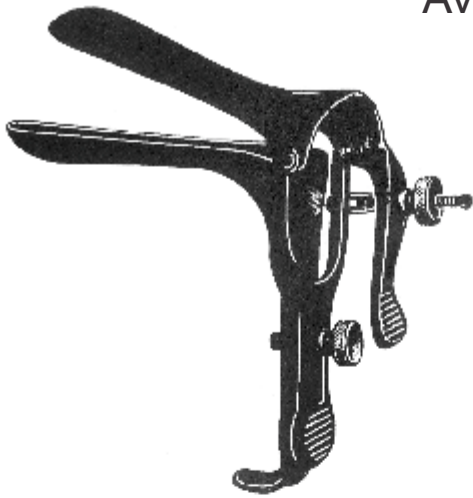

Laser Graves Vaginal Speculum

<b>16S-001</b>	3" x ¾"	Small
<b>16S-002</b>	4" x 1¼"	Medium
<b>16S-003</b>	4½" x 1¾"	Large
<b>16S-004</b>	3" x ½"	Extra Small
<b>16S-005</b>	4 ¼" x 1½"	Extra Large



Laser Pederson Vaginal Speculum

<b>16S-006</b>	3" x ½"	Small
<b>16S-007</b>	4¼" x 1"	Large
<b>16S-008</b>	4" x 5/8"	Slender
<b>16S-009</b>	4" x 7/8"	Medium
<b>16S-010</b>	2¾" x 5/8"	Extra Small



Laser Cusco Vaginal Speculum

<b>16S-011</b>	3" x ¼"	Small
<b>16S-012</b>	3½" x 1"	Medium
<b>16S-013</b>	3 ¾" x 5/8"	Large

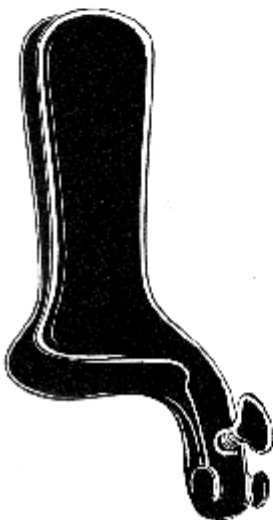

Laser Collin Vaginal Speculum



Laser Auvard Vaginal Speculum

<b>16S-014</b>	1¼" x 3¼"	Small
<b>16S-015</b>	1¾" x 4"	Medium
<b>16S-016</b>	1¾" x 4½"	Large

<b>16S-017</b>	2½ lbs. Without loop	Medium
<b>16S-018</b>	2½ lbs. With loop	Medium

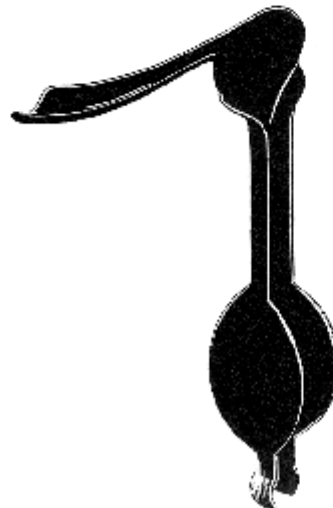

Laser Steiner-Auvard Vaginal Speculum

<b>16S-019</b>	2½ lbs. Without loop	Medium
<b>16S-020</b>	2½ lbs. With loop	Medium



**16S-021**  
Laser Lateral Vaginal Speculum 8 ¼" (21 cm)

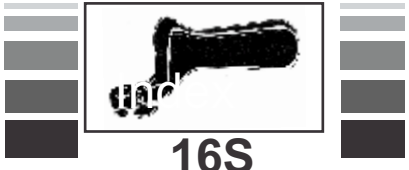

# LASER SURGERY INSTRUMENTS



Available in Black & Blue Laser Coating

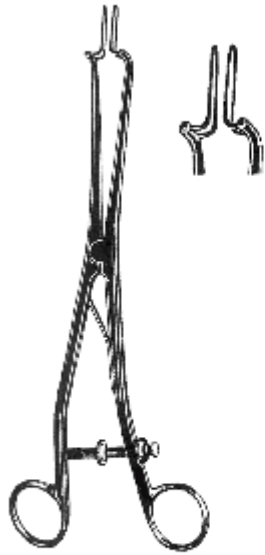

Laser Kogan Endospeculum

<b>16S-022</b>	9½" (24 cm)
<b>16S-023</b>	11" (28 cm)



Laser Kogan Endospeculum

<b>16S-024</b>	9½" (24 cm)
<b>16S-025</b>	11" (28 cm)

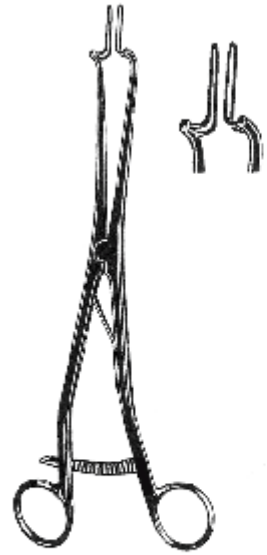

Laser Kogan Endospeculum

<b>16S-026</b>	9½" (24 cm)
<b>16S-027</b>	11" (28 cm)



**16S-028**  
Laser Kogan  
Endospeculum 9"  
(23 cm)



**16S-029**

Laser Campion Grasping Forceps  
Curved 9" (23cm)



**16S-030**  
Laser Bozeman Forceps  
One Large Ring 10" (25 cm)



**16S-031**  
Laser Bozeman  
Forceps S-Curve  
10" (25 cm)



Laser Schroeder Tenaculum Forceps

<b>16S-032</b>	9½" (24 cm)	(Braun)
<b>16S-033</b>	10 ¼" (26 cm)	(Pozzi)

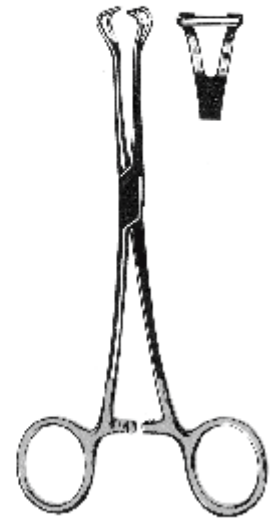

**16S-034**  
Laser Babcock  
Forceps 8" (20  
cm)

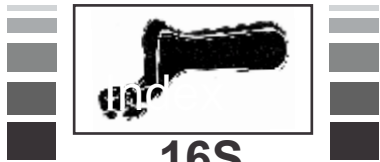

# LASER SURGERY INSTRUMENTS



Available in Black & Blue Laser Coating

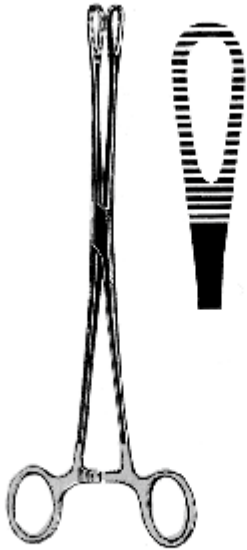

**16S-035**  
Laser Schweizer  
Forceps Straight 9 1/2"  
(24 cm)



**16S-036**  
Laser Clemestson  
Forceps 9 1/2" (24 cm)



**16S-037**  
Laser Laufe Uterine Polyp  
Forceps Curved 7 3/4" (19,5 cm)



**16S-038**  
Laser Heaney Needle  
Holder 8 1/4" (21 cm)

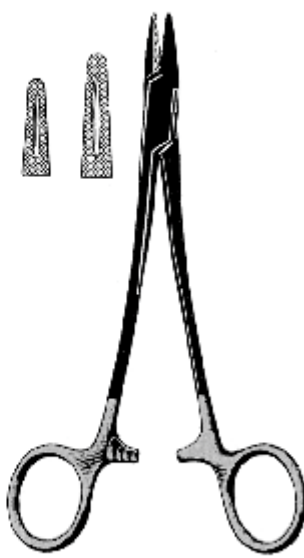

Laser Mayo-Hegar Needle Holder

<b>16S-039</b>	7" (18 cm)
<b>16S-040</b>	8" (20 cm)



**16S-041**  
Laser Jackson  
Retractor 3 1/2" x 1 1/2"



Laser Backhaus Towel Clamp

<b>16S-043</b>	3 1/2" (9 cm)
<b>16S-044</b>	5 1/4" (13 cm)



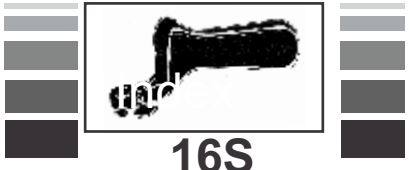

# LASER SURGERY INSTRUMENTS



Available in Black & Blue Laser Coating



Laser Allis Tissue Forceps

<b>16S-045</b>	5" (12,5 cm)	Baby Allis
<b>16S-046</b>	7½" (19 cm)	Allis, 5 x 6
<b>16S-047</b>	9½" (24 cm)	Allis, 5 x 6



Potts-Smith Forceps

<b>16S-048</b>	7" (18 cm)	Serrated
<b>16S-049</b>	10" (25 cm)	Serrated



De-Bakey Atraumatic Tissue Forceps  
2,0 mm Jaws

<b>16S-050</b>	7¾" (19,5 cm)
<b>16S-051</b>	9½" (24 cm)



Laser Tuttle / Singly Forceps

<b>16S-052</b>	7" (18 cm)	Tuttle
<b>16S-053</b>	9" (23 cm)	Singly



**16S-054**  
Laser Adson Tissue  
Forceps Serrated,  
4¾" (12 cm)



Laser Rochester-Pean Forceps

<b>16S-055</b>	7¼" (18,5 cm)	Straight
<b>16S-056</b>	7¼" (18,5 cm)	Curved





17S

# HOLLOWWARE



Forceps Jar

ARTICLE #	SIZE
17S-001	2" x 5"
17S-002	4" x 8"



17S-003  
Oiment Jar  
Size: 08oz



17S-004  
Cotton Wool Dispenser



17S-005  
Cotton Wool Dispenser



17S-006  
Alcohol Lamp

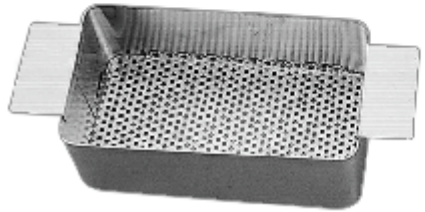

17S-007  
Sterilizing Tray  
8½" x 4½" x 3"



Kidney Tray

ARTICLE #	SIZE
17S-008	150 mm
17S-009	170 mm
17S-010	200 mm
17S-011	250 mm
17S-012	280 mm
17S-013	300 mm



Instrument Tray

ARTICLE #	SIZE
17S-014	150 x 100 x 40 mm
17S-015	200 x 150 x 40 mm
17S-016	255 x 200 x 40 mm
17S-017	300 x 150 x 40 mm
17S-018	300 x 200 x 50 mm
17S-019	300 x 255 x 50 mm
17S-020	310 x 200 x 60 mm
17S-021	330 x 250 x 50 mm
17S-022	355 x 255 x 50 mm
17S-023	355 x 300 x 50 mm
17S-024	400 x 300 x 55 mm
17S-025	460 x 300 x 55 mm
17S-026	460 x 360 x 55 mm



Instrument Tray with Lid

ARTICLE #	SIZE
17S-027	150 x 100 x 40 mm
17S-028	200 x 150 x 40 mm
17S-029	255 x 200 x 40 mm
17S-030	300 x 150 x 40 mm
17S-031	300 x 200 x 50 mm
17S-032	300 x 255 x 50 mm
17S-033	310 x 200 x 60 mm
17S-034	330 x 250 x 50 mm
17S-035	355 x 255 x 50 mm
17S-036	355 x 300 x 50 mm
17S-037	400 x 300 x 55 mm
17S-038	460 x 300 x 55 mm
17S-039	460 x 360 x 55 mm



Catheter Tray

ARTICLE #	SIZE
17S-040	300 x 75 x 40 mm
17S-041	350 x 90 x 50 mm
17S-042	400 x 100 x 50 mm



Mayo Tray

ARTICLE #	SIZE
17S-043	400 x 300 x 20 mm
17S-044	450 x 320 x 20 mm
17S-045	460 x 360 x 20 mm



17S

# HOLLOWWARE

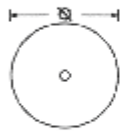

Cotton Wool Container

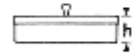

Lid with Knob



Ø x h	
75 x 60	<b>17S-046</b>
75 x 75	<b>17S-047</b>
100 x 60	<b>17S-048</b>
100 x 100	<b>17S-049</b>
125 x 80	<b>17S-050</b>
125 x 125	<b>17S-051</b>
150 x 150	<b>17S-052</b>

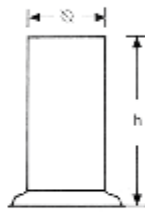

JAR

Ø x h	Jar without Lid	Lid Only	Lid Only with Triangle hole
30 x 90	<b>17S-053</b>		
50 x 100	<b>17S-054</b>	<b>17S-061</b>	<b>17S-068</b>
50 x 130	<b>17S-055</b>	<b>17S-062</b>	<b>17S-069</b>
50 x 175	<b>17S-056</b>	<b>17S-063</b>	<b>17S-070</b>
75 x 100	<b>17S-057</b>	<b>17S-064</b>	<b>17S-071</b>
75 x 130	<b>17S-058</b>	<b>17S-065</b>	<b>17S-072</b>
100 x 175	<b>17S-059</b>	<b>17S-066</b>	<b>17S-073</b>
100 x 200	<b>17S-060</b>	<b>17S-067</b>	<b>17S-074</b>

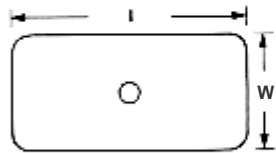

Instrument Box

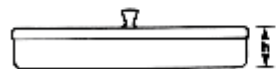

Size in mm l x b x h	Lid with Knob	Lid without Knob
165 x 85 x 35	<b>17S-075</b>	<b>17S-083</b>
200 x 100 x 35	<b>17S-076</b>	<b>17S-084</b>
200 x 100 x 50	<b>17S-077</b>	<b>17S-085</b>
230 x 130 x 50	<b>17S-078</b>	<b>17S-086</b>
260 x 150 x 50	<b>17S-079</b>	<b>17S-087</b>
270 x 235 x 50	<b>17S-080</b>	<b>17S-088</b>
300 x 200 x 50	<b>17S-081</b>	<b>17S-089</b>
325 x 275 x 50	<b>17S-082</b>	<b>17S-090</b>



**17S-091** Bucket  
Only Size:  
Dia: 335 mm  
Height: 240 mm  
Base: 215 mm

**17S-092**  
Bucket Kick  
Stand (Stand  
Only)



17S

# HOLLOWWARE



Sterilizer Drum

ARTICLE #	SIZE
17S-093	80 x 80 mm
17S-094	120 x 120 mm
17S-095	140 x 140 mm
17S-096	160 x 120 mm
17S-097	160 x 150 mm
17S-098	190 x 150 mm
17S-099	190 x 190 mm
17S-100	240 x 160 mm
17S-101	240 x 240 mm
17S-102	290 x 160 mm
17S-103	290 x 240 mm
17S-104	340 x 160 mm
17S-105	340 x 240 mm
17S-106	390 x 190 mm
17S-107	390 x 290 mm



Emises Basin

17S-108	12" ( 4 LTR)
17S-109	13" (6 LTR)
17S-110	14" (8 LTR)



17S-111  
Urinal - Male



17S-112  
Urinal - Female



17S-113  
Bedpan Slipper Type



17S-114  
Bedpan American

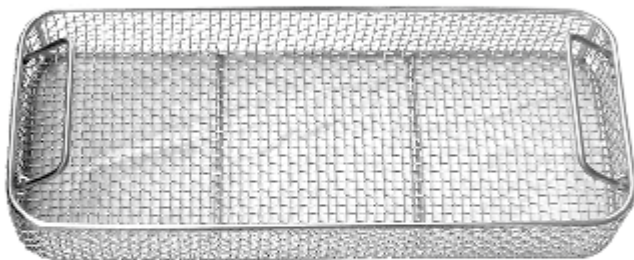

Wire Mesh Tray

ARTICLE #	SIZE
17S-115	230 x 130 x 50 mm
17S-116	240 x 130 x 50 mm
17S-117	240 x 250 x 60 mm
17S-118	480 x 250 x 50 mm
17S-119	480 x 250 x 70 mm
17S-120	500 x 300 x 50 mm
17S-121	480 x 480 x 50 mm
17S-122	300 x 300 x 60 mm
17S-123	500 x 300 x 60 mm
17S-124	600 x 300 x 60 mm



Sterilizing Container

ARTICLE #	SIZE
17S-125	220 x 120 x 50 mm
17S-126	230 x 130 x 50 mm
17S-127	260 x 150 x 50 mm
17S-128	300 x 200 x 50 mm



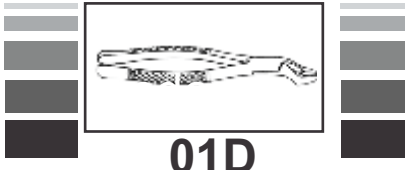

# EXTRACTING FORCEPS

(American Pattern)

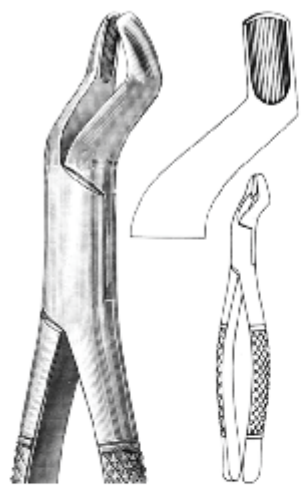

**01D-001**  
Upper Molars,  
Universal # 10S

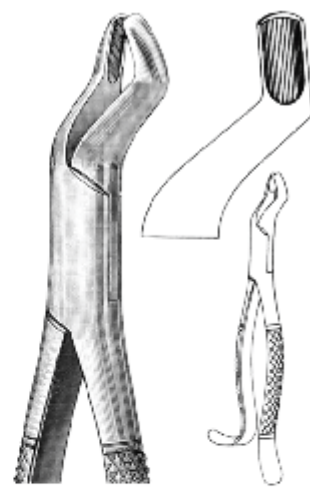

**01D-002**  
Upper Molars, Hook  
Handle, Universal # 10H

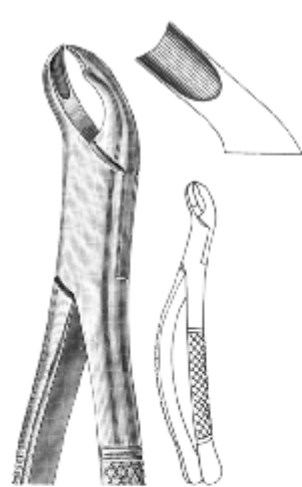

**01D-003**  
Upper Molars,  
Left # 90

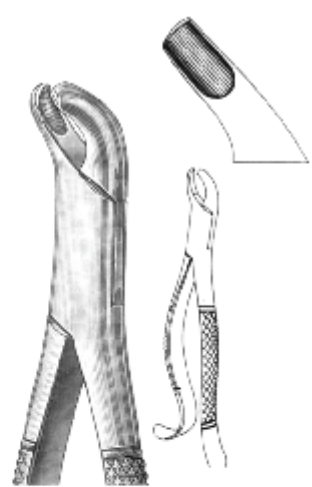

**01D-004**  
1st & 2nd Upper  
Molar, Left # 18L

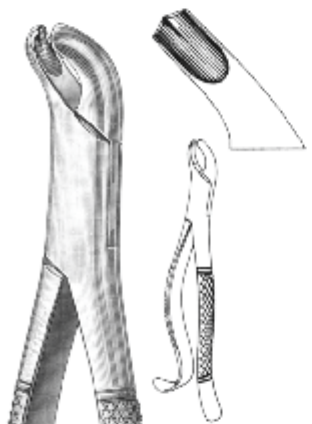

**01D-005**  
1st & 2nd Upper  
Molar, Right # 18R

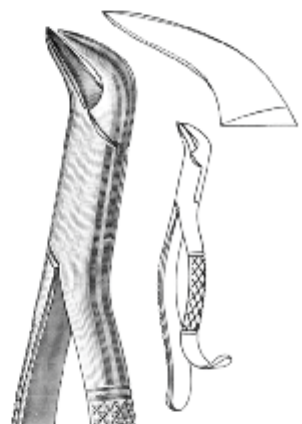

**01D-006**  
1st & 2nd Lower  
Molars, Universal,  
Cow Horn # 16

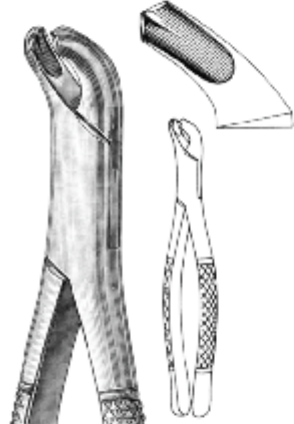

**01D-007**  
1st & 2nd Lower  
Molars, Universal # 17



**01D-008**  
1st & 2nd Lower Molars,  
Universal, Cow Horn # 23

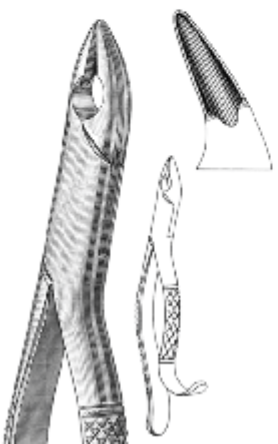

**01D-009**  
Lower Molars, Cuspids  
& Bicuspids, Universal # 85

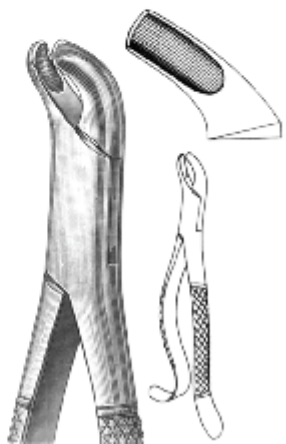

**01D-010**  
Upper Molars,  
Universal # 24

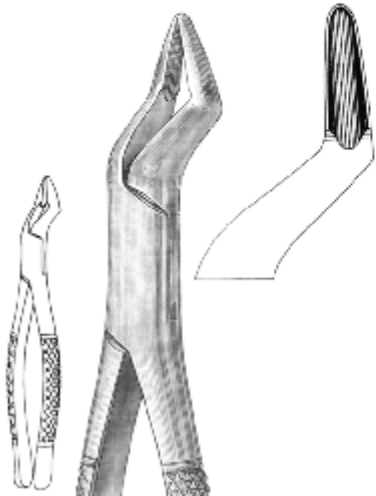

**01D-011**  
Upper Cuspid, Bicuspids  
& Molars, Universal # 32

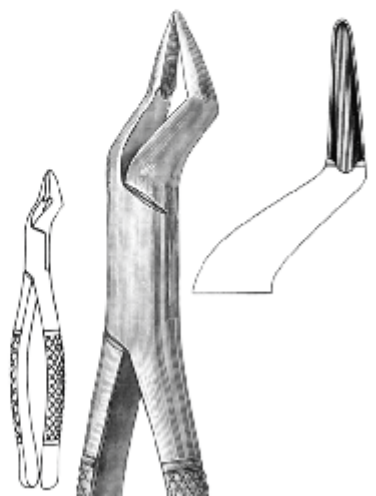

**01D-012**  
Upper Cuspid, Bicuspids  
& Molars, Universal # 32A

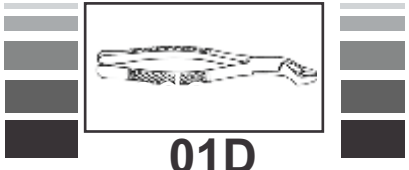

# EXTRACTING FORCEPS

(American Pattern)

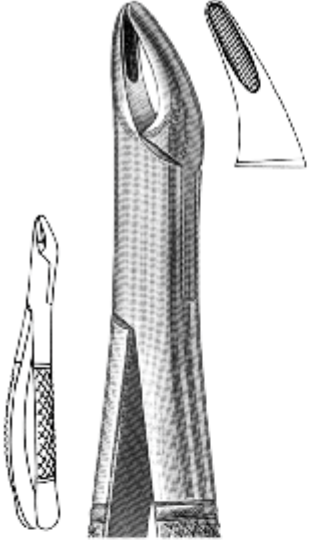

**01D-013**  
Upper Incisors, Cuspid,  
Bicuspids & Roots;  
Universal # 150

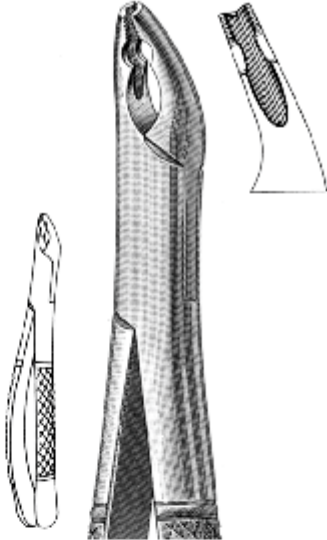

**01D-014**  
Upper Anteriors; Split  
Beaks; Serrated # 150AS

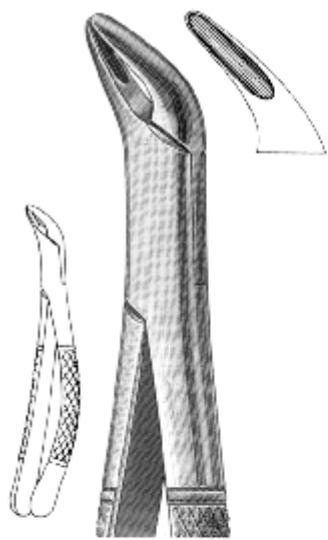

**01D-015**  
Lower Incisors, Cuspid,  
Bicuspids & Roots;  
Universal # 151

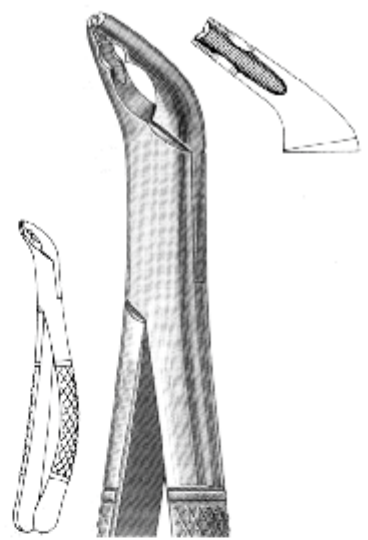

**01D-016**  
Lower Anteriors; Split  
Beaks; Serrated # 151 AS

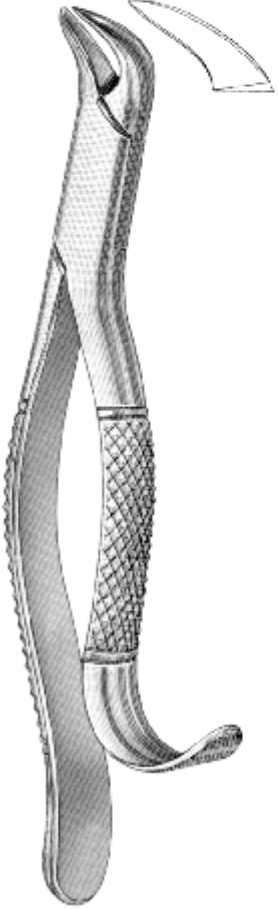

**01D-017**  
Pedo Lower Molars,  
Cow Horn # 16S

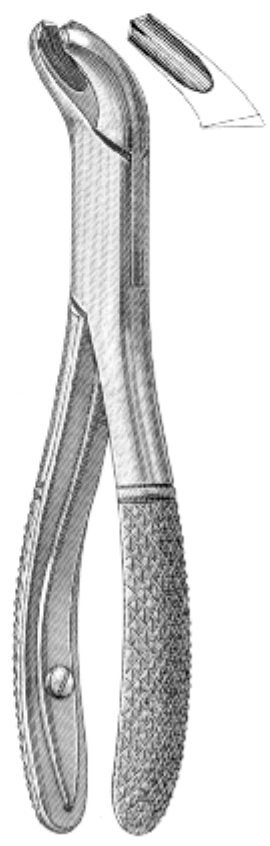

**01D-018**  
Pedo Lower Molars  
Universal, Spring  
Handle # 17S

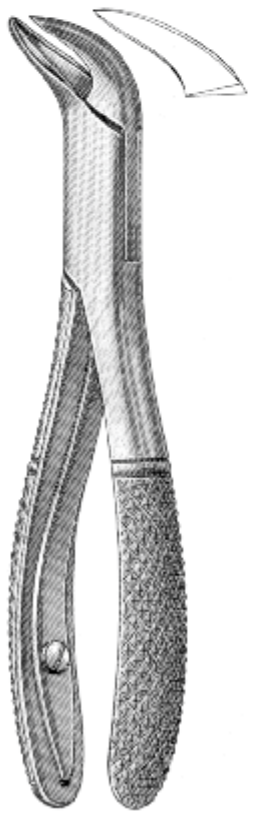

**01D-019**  
Pedo Lower Molars  
Universal, Cow Horn,  
Spring Handle # 23S

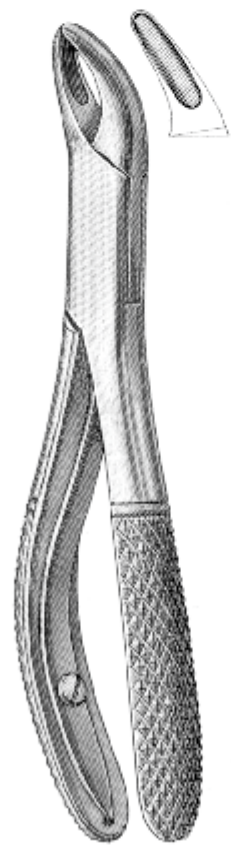

**01D-020**  
Pedo Upper Incisors, Bicuspids  
& Roots, Universal, Spring Handle  
# 150½S

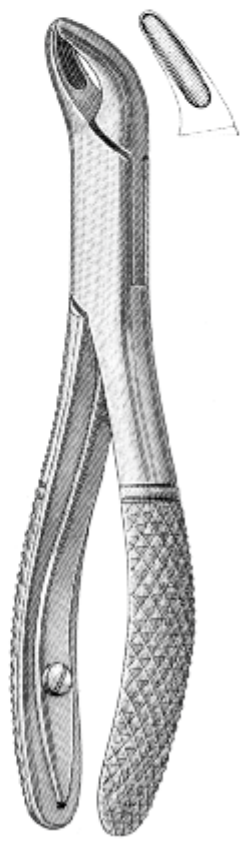

**01D-021**  
Pedo Lower Incisors, Bicuspids  
& Roots, Universal, Spring Handle  
# 151½S



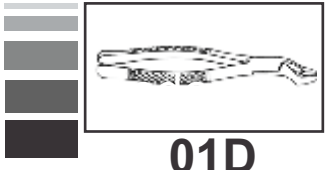

**01D**

**EXTRACTING FORCEPS**  
(European Pattern)

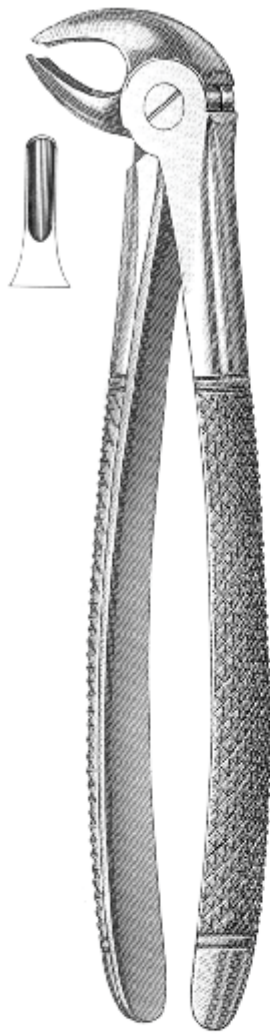

**01D-022**  
Lower Bicuspid,  
Universal # 13

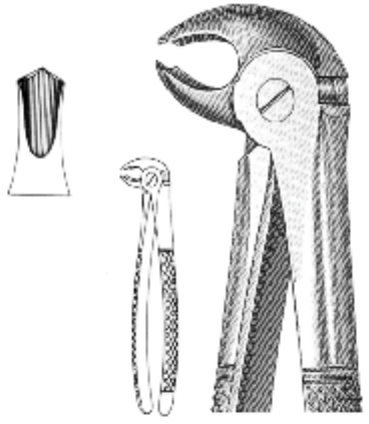

**01D-023**  
Lower Molars,  
Universal # 22

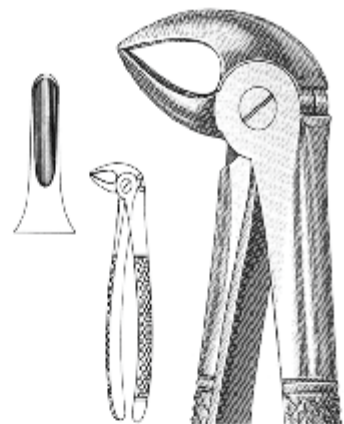

**01D-024**  
Lower Roots # 23



**01D-025**  
Lower Roots,  
Narrow Beaks # 27



**01D-026**  
Lower Molars,  
Universal # 73

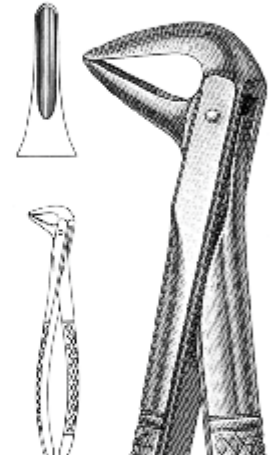

**01D-027**  
Lower Roots # 74

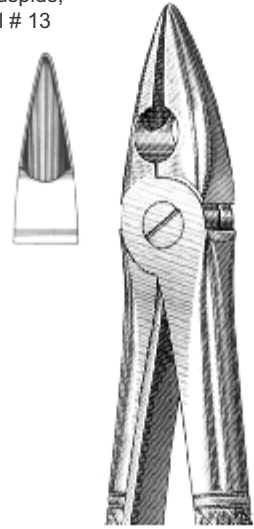

**01D-028**  
Upper Incisors, Cuspids,  
Bicuspid and Roots,  
Mead, Universal # MD1

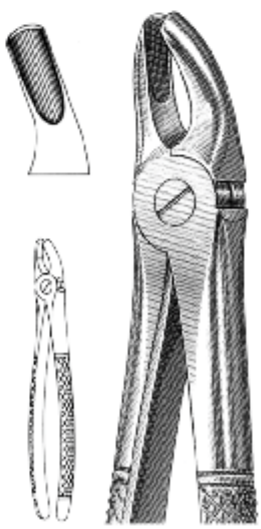

**01D-029**  
Upper 1st, 2nd and 3rd  
Molars, Mead, Universal #  
MD2

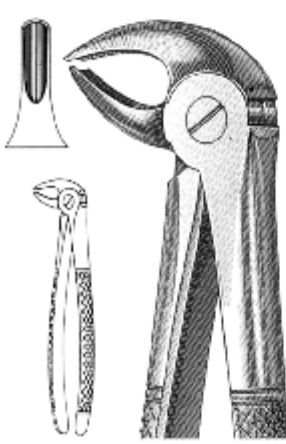

**01D-030**  
Lower Incisors, Cuspids,  
Bicuspid and Roots,  
Mead, Universal # MD3

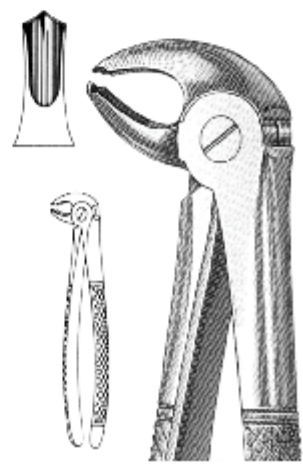

**01D-031**  
Lower 1st, 2nd and 3rd  
Molars, Mead, Universal # MD4



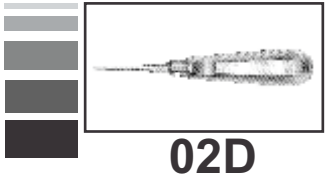

# ELEVATORS

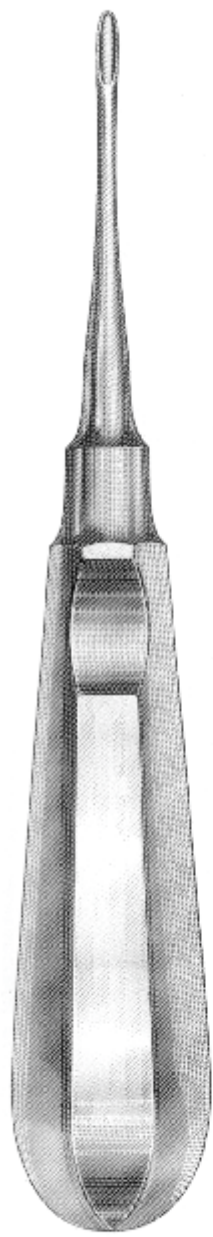

02D-001



02D-002



02D-003

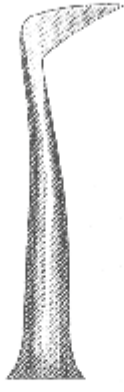

02D-004

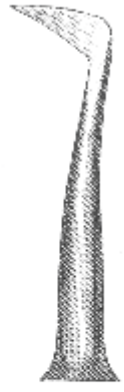

02D-005

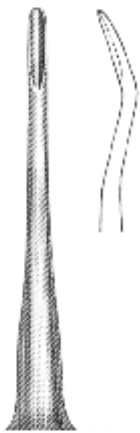

02D-006

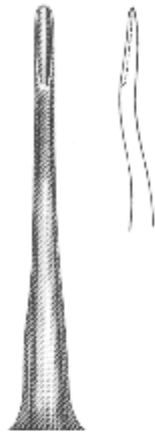

02D-007

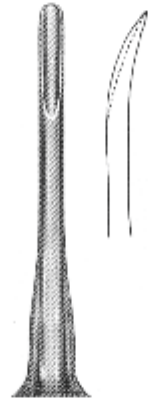

02D-008

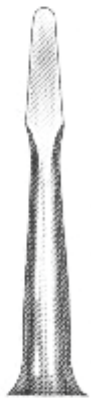

02D-009



02D-010



02D-011

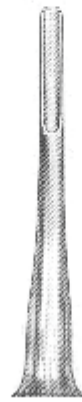

02D-012

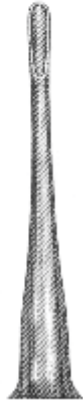

02D-013

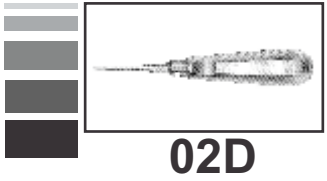

02D

# ELEVATORS



## Root Tip

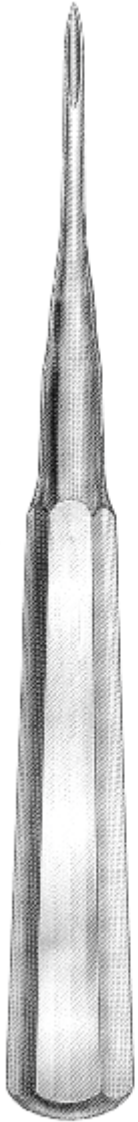

02D-014



02D-015



02D-016

## Heidbrink Root-Tip Picks



02D-017



02D-018



02D-019



02D-020

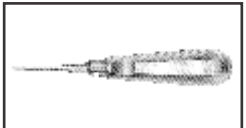

02D

# ELEVATORS



## Potts Elevator

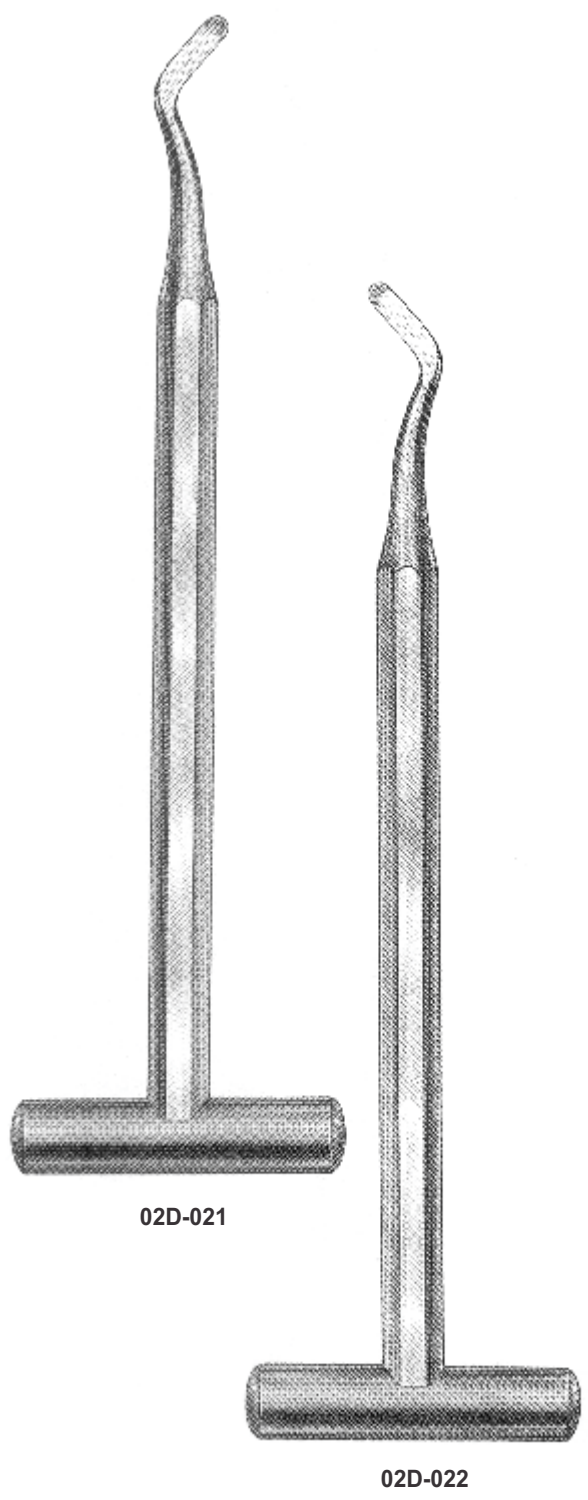

02D-021

02D-022

## Priosteal Elevator

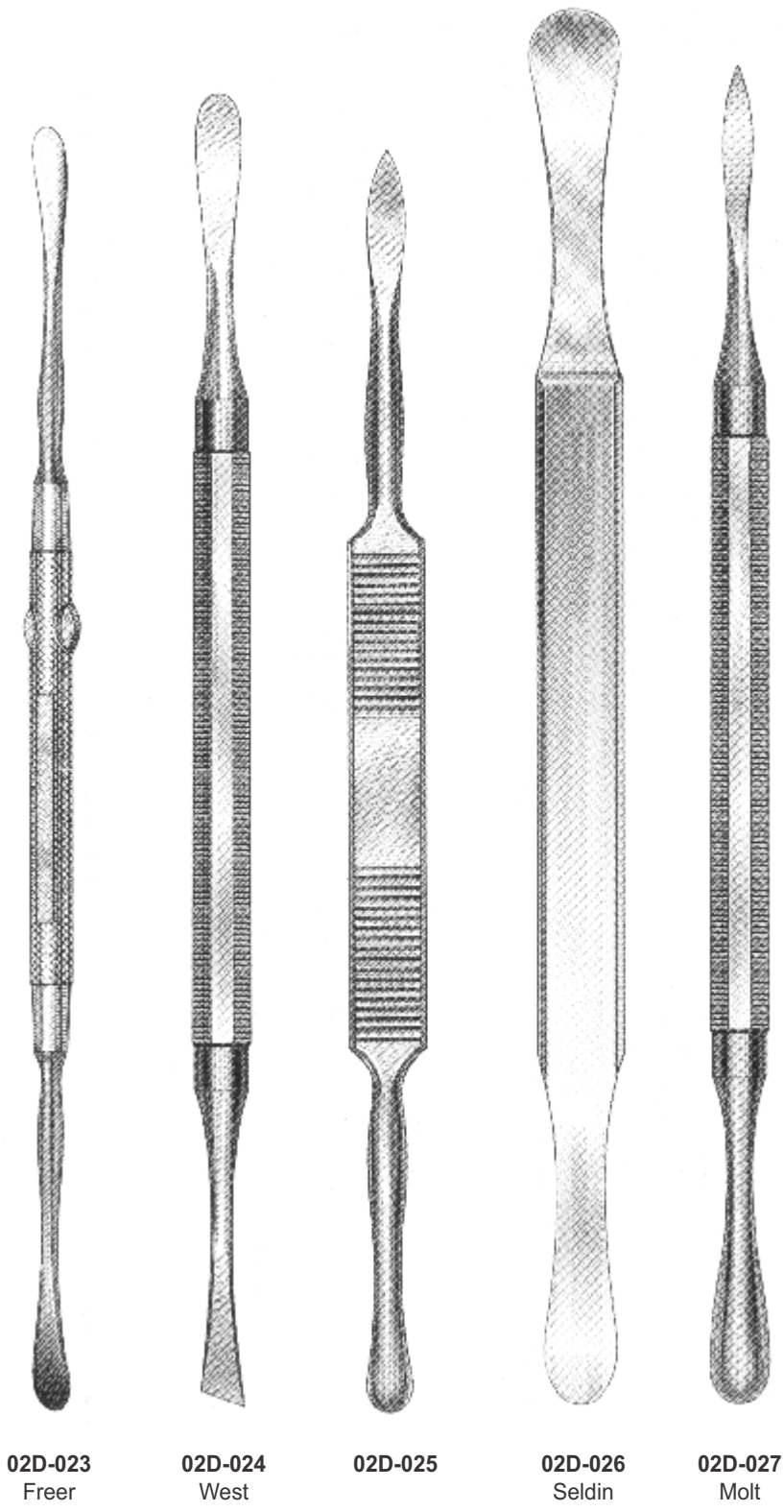

02D-023  
Freer

02D-024  
West

02D-025

02D-026  
Seldin

02D-027  
Molt

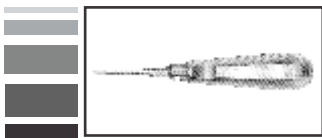

02D

# ELEVATORS



## Lucas

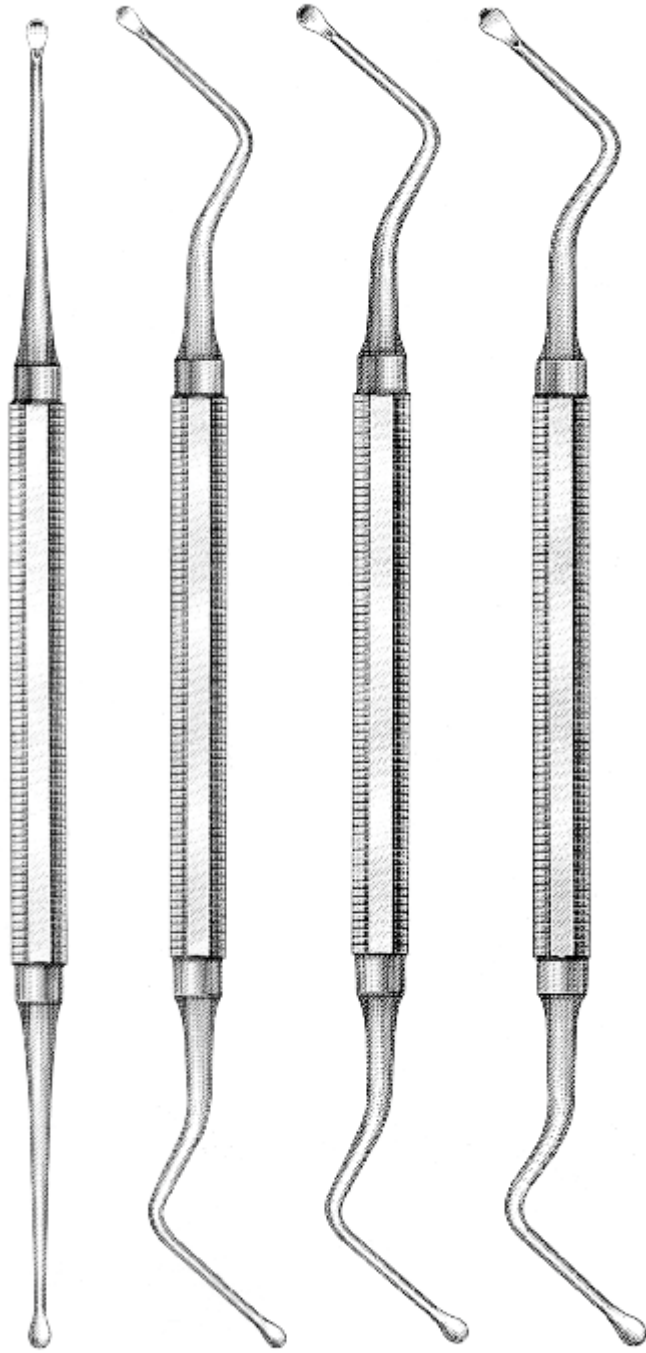

02D-028

02D-029

02D-030

02D-031

## Muli

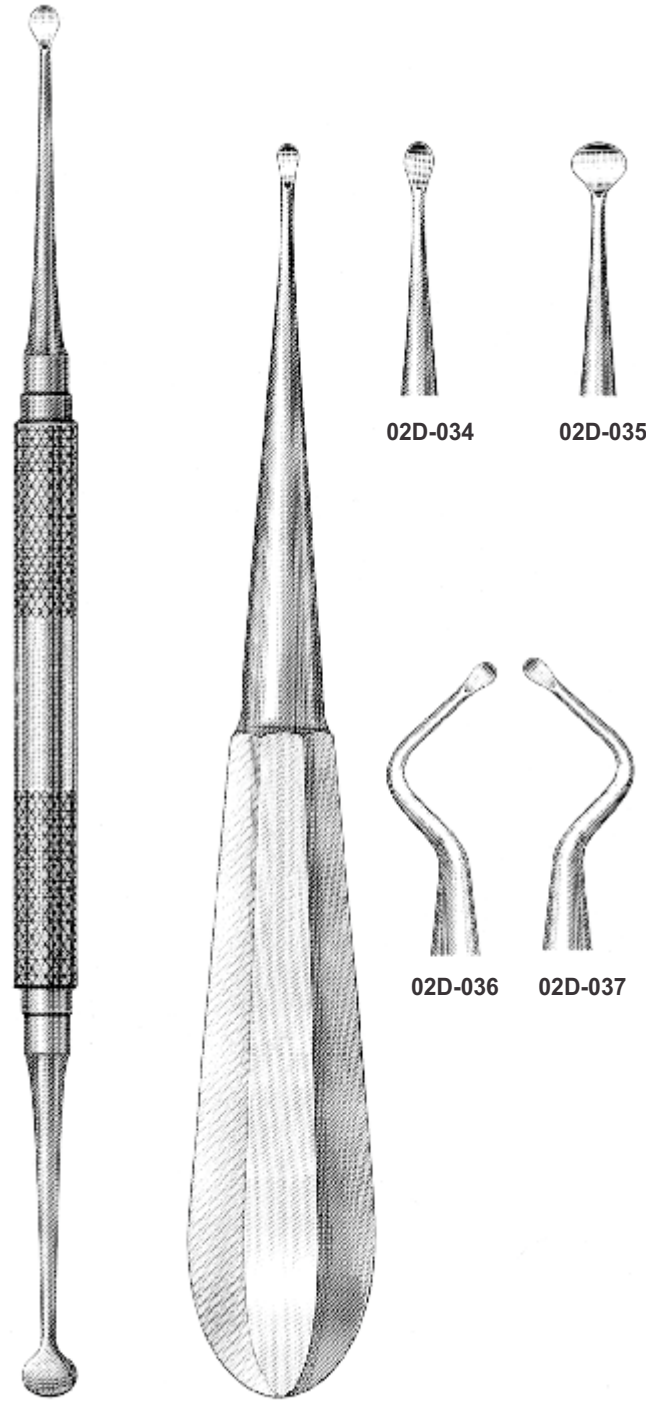

02D-032

02D-033

02D-034

02D-035

02D-036

02D-037





**03D**

**MIRROR + HANDLE**



**CONE SOCKET  
Mirror Only**

03D-	#
001	3
03D-	#
002	4
03D-	#
003	5



**SIMPLE STEM  
Mirror Only**

03D-	#
004	3
03D-	#
005	4
03D-	#
006	5

20  
mm  
Size  
3

22  
mm  
7/8"  
Size  
4

24  
mm  
15/16"  
Size  
5



**03D-007**  
Octagonal Dental Mirror Handle



**03D-008**  
Delux Dental Mirror Handle



**03D-009**  
Octagonal Dental Mirror Handle, with millimeter rule



**03D-010**  
Double End Dental Mirror Handle



**03D-011**  
Autoclavable Front Surface Fiberglass Mirror



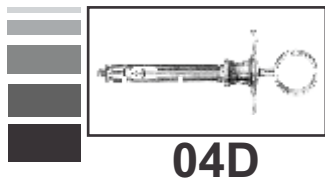

# AMALGAM CARRIERS & SYRINGES



Amalgam Carriers Swiss Pattern



04D-001

04D-002

04D-003

Amalgam Carriers

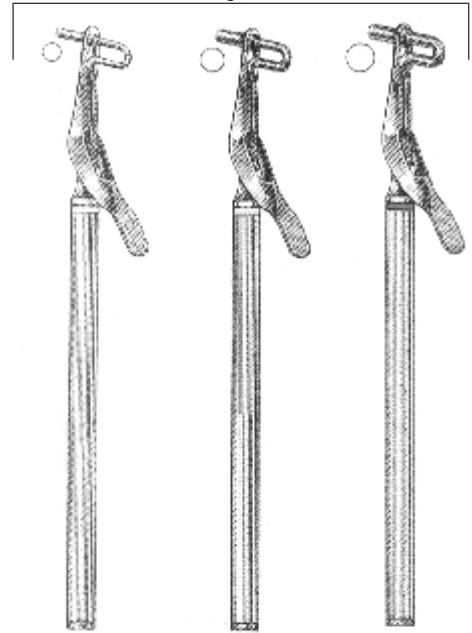

04D-004  
Small

04D-005  
Medium

04D-006  
Large

Amalgam Carriers (Double End)

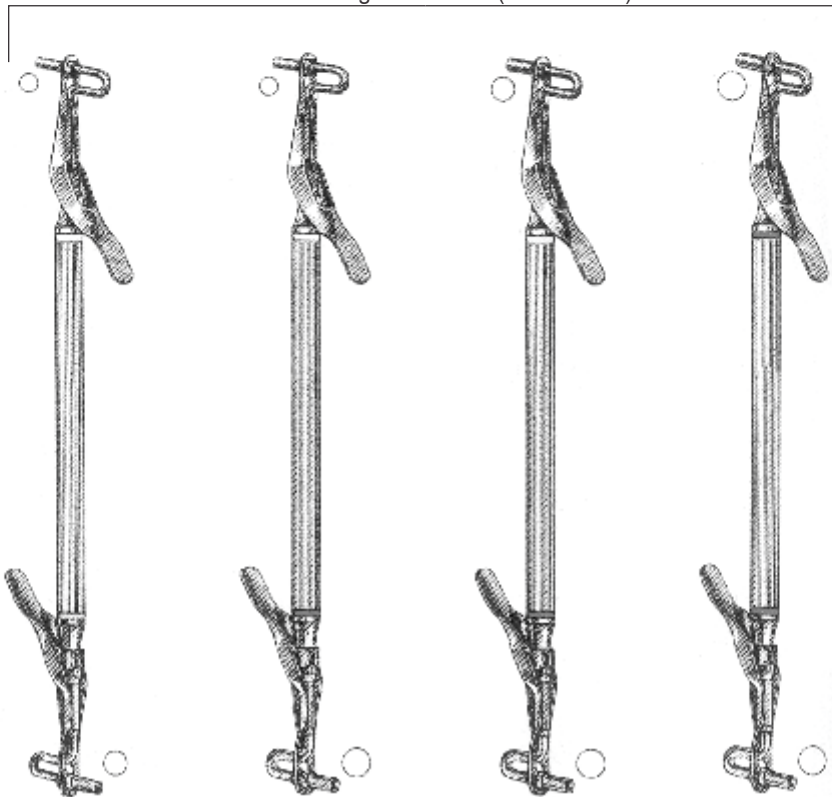

04D-007  
Large/Medium

04D-008  
Small/Large

04D-009  
Medium/Large

04D-010  
Large/Large

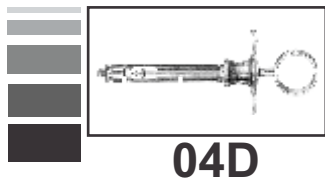

04D

# AMALGAM CARRIERS & SYRINGES

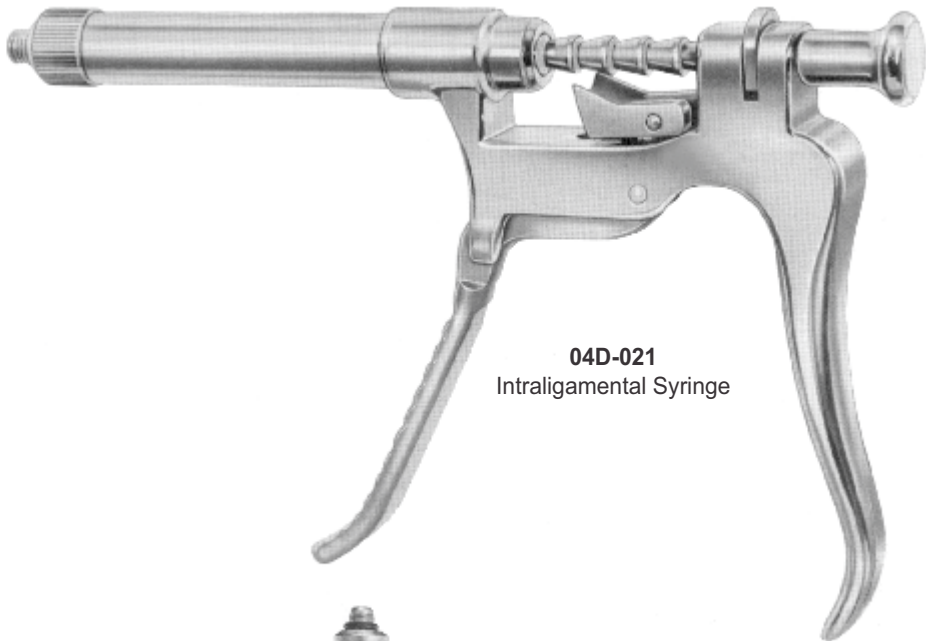

**04D-021**  
Intraligamental Syringe

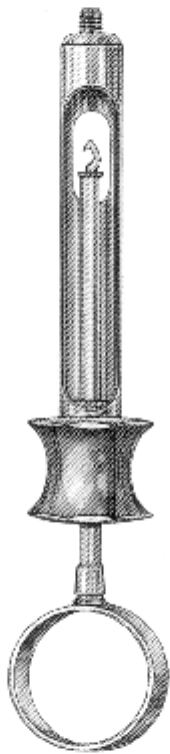

Aspirating Syringe  

<b>04D-013</b>	1,8 cc
<b>04D-014</b>	2,2 cc



Self-Aspirating Syringe  

<b>04D-017</b>	1,8 cc
<b>04D-018</b>	2,2 cc

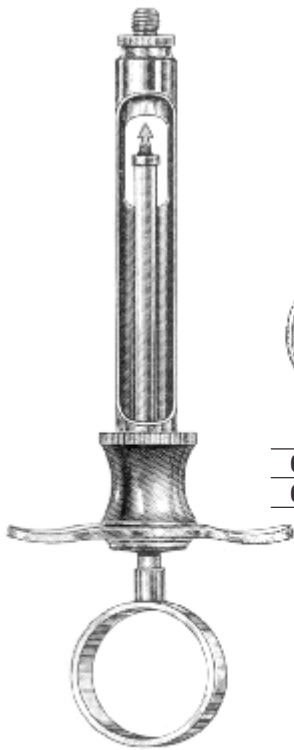

Aspirating Syringe  

<b>04D-011</b>	1,8 cc
<b>04D-012</b>	2,2 cc

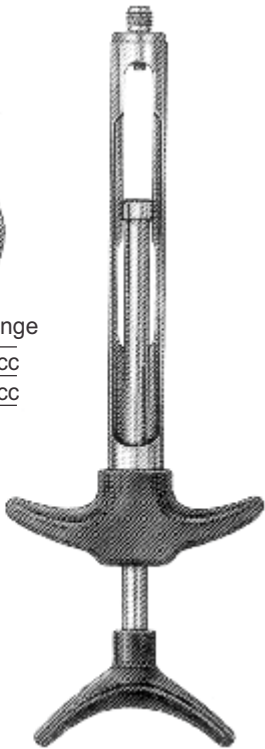

Self-Aspirating Syringe  

<b>04D-015</b>	1,8 cc
<b>04D-016</b>	2,2 cc



Articulating Barrel Syringe  
(Shown Open)  

<b>04D-019</b>	1,8 cc
<b>04D-020</b>	2,2 cc



**05D**

**MISCELLANEOUS**



**05D-001**  
Cow Horn



**05D-002**  
Stiff Blade



**05D-003**  
Stiff Blade



**05D-004**  
Extra Stiff Blade



**05D-005**  
Flexible Blade



**05D-006**  
Ball Chain



**05D-007**  
Non-Chill  
Clear  
Plastic

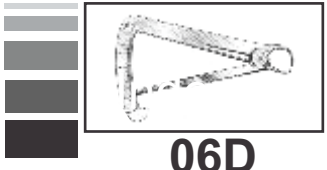

**06D**

**TUFFLIMIRE, CALIPERS ETC**



**06D-008**



**06D-009**

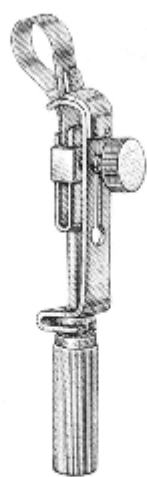

**06D-010**



**06D-011  
JUNIOR-CA**



**06D-012  
SENIOR-CA**



**06D-013  
Universal**

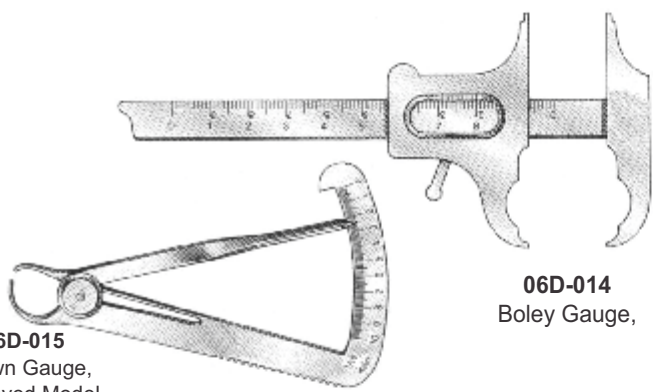

**06D-014  
Boley Gauge,**

**06D-015  
Crown Gauge,  
Improved Model  
with 2 Sided Scale**

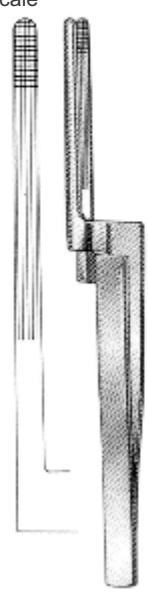

**06D-016  
Standard Articulating Paper Forceps,**

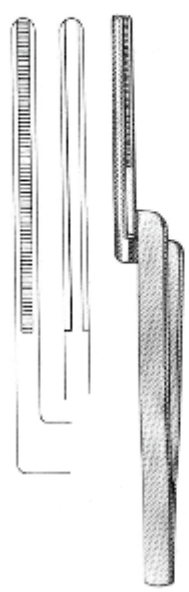

**06D-017  
POSIGRIP Articulating  
Paper Forceps,**

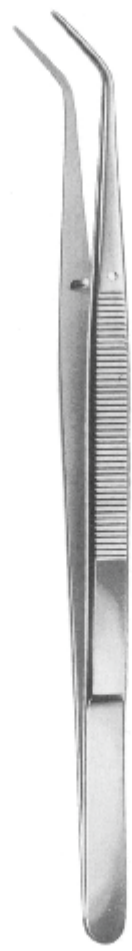

**06D-018  
London College Tweezer  
Smooth  
6" (15 cm)**



**06D-019  
London College Tweezer  
Serrated  
6" (15 cm)**

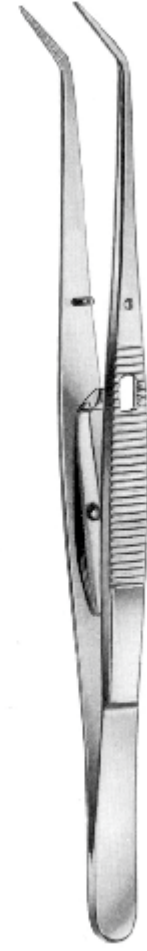

**06D-020  
London College Tweezer  
Serrated/with lock  
6" (15 cm)**



**06D-021  
Meriam Serrated  
6 1/4" (16 cm)**



**06D-022  
Meriam Smooth  
6 1/4" (16 cm)**



07D

### GRACEY CURETTE

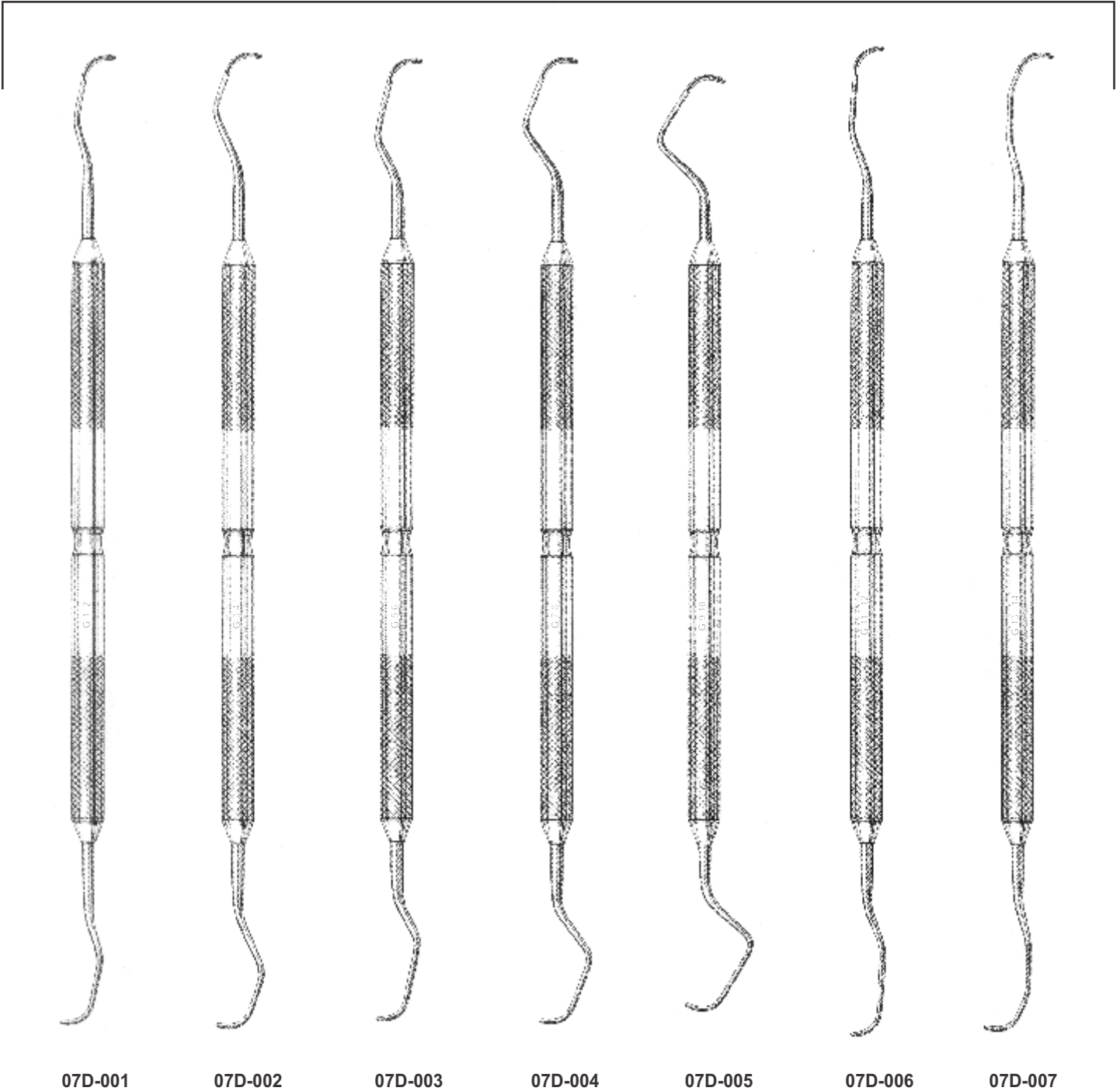





07D

**COLUMBIA CURETTES**

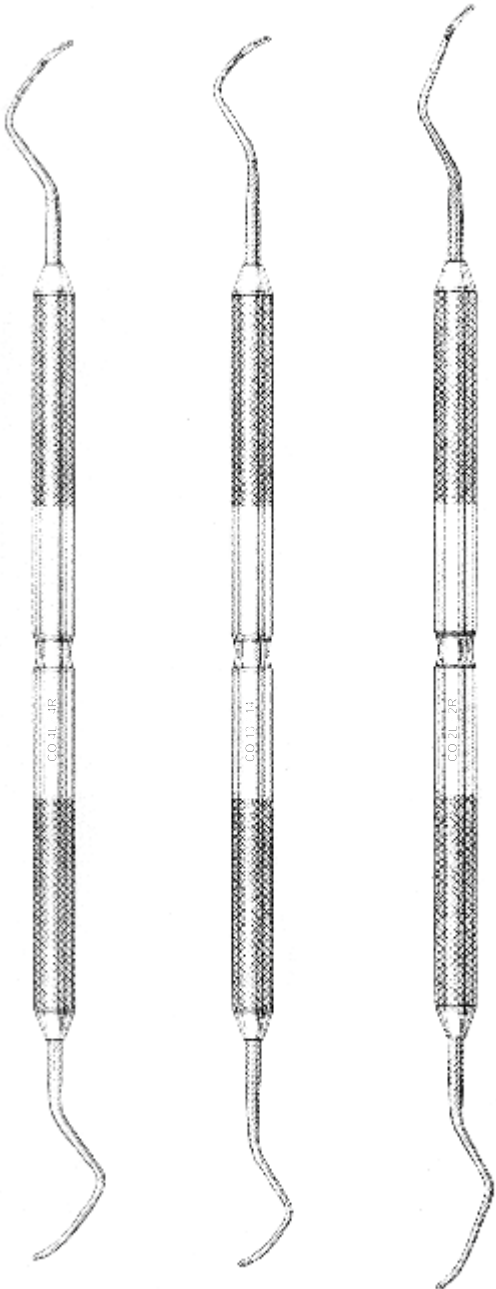

07D-008  
4L-4R

07D-009  
13-14

07D-010  
2L-2R

**MCCALLS CURETTES**

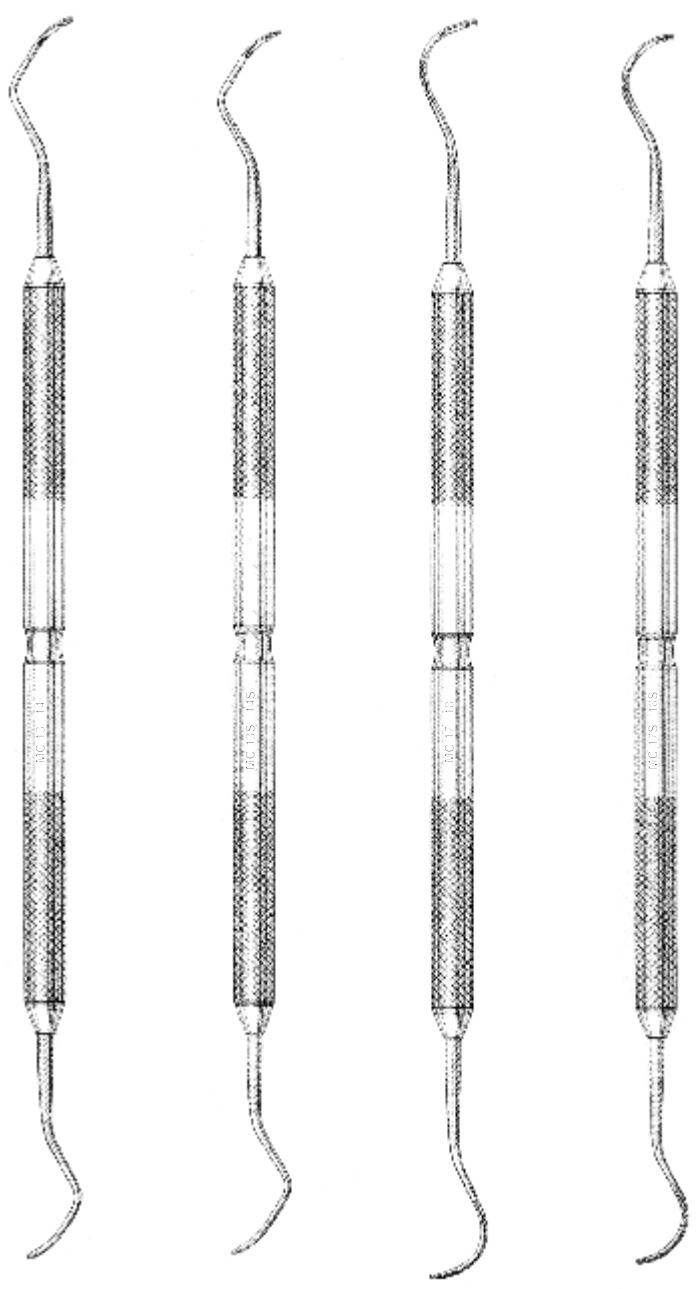

07D-011  
13-14

07D-012  
13S-14S

07D-013  
17-18

07D-014  
17S-18S



07D

### WAX CARVERS

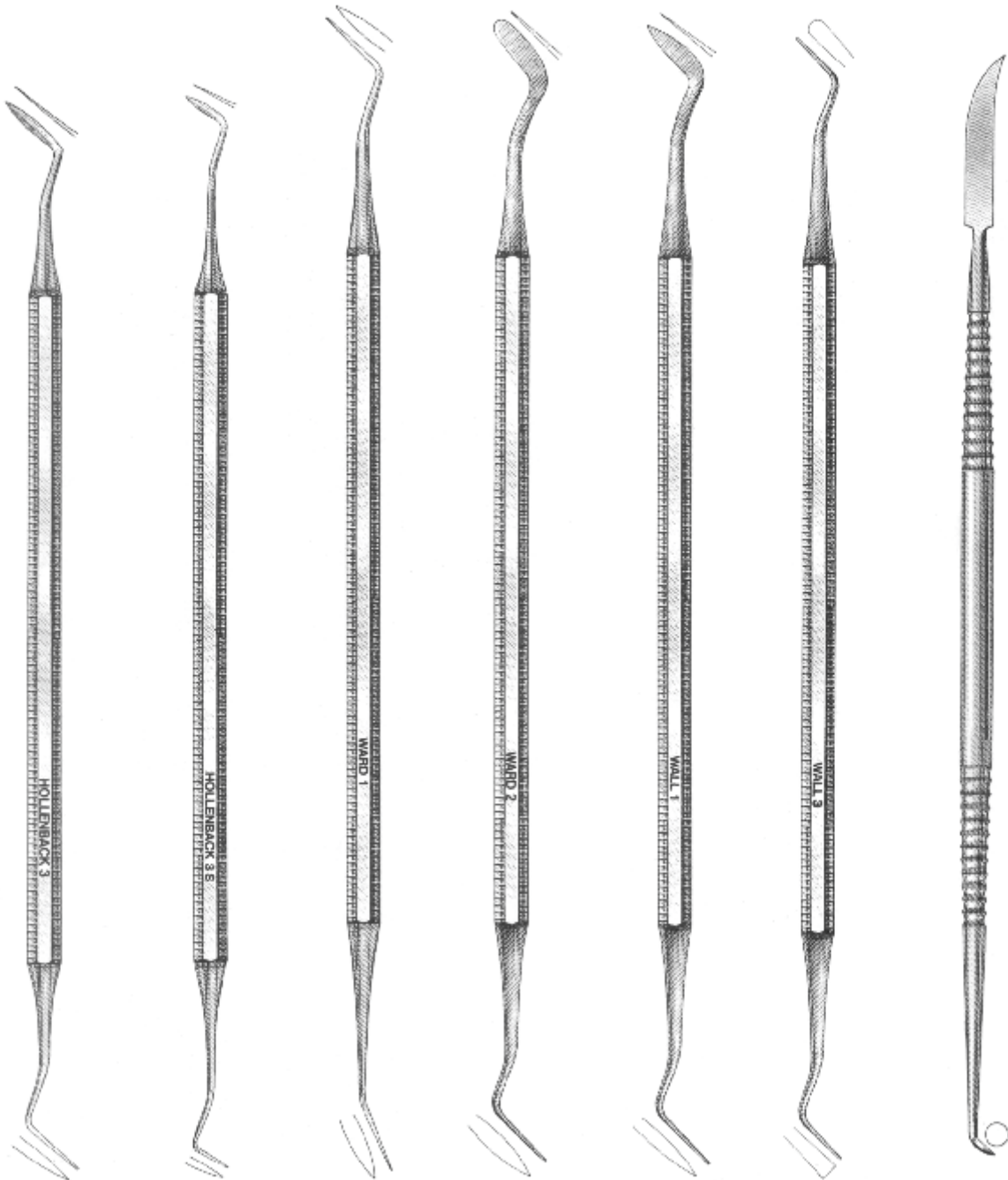

07D-015  
Hollenback

07D-016  
Hollenback

07D-017  
Ward

07D-018  
Ward

07D-019  
Wall

07D-020  
Wall

07D-021  
Lecron



07D

# GENERAL DENTISTRY INSTRUMENTS



## EXCAVATORS

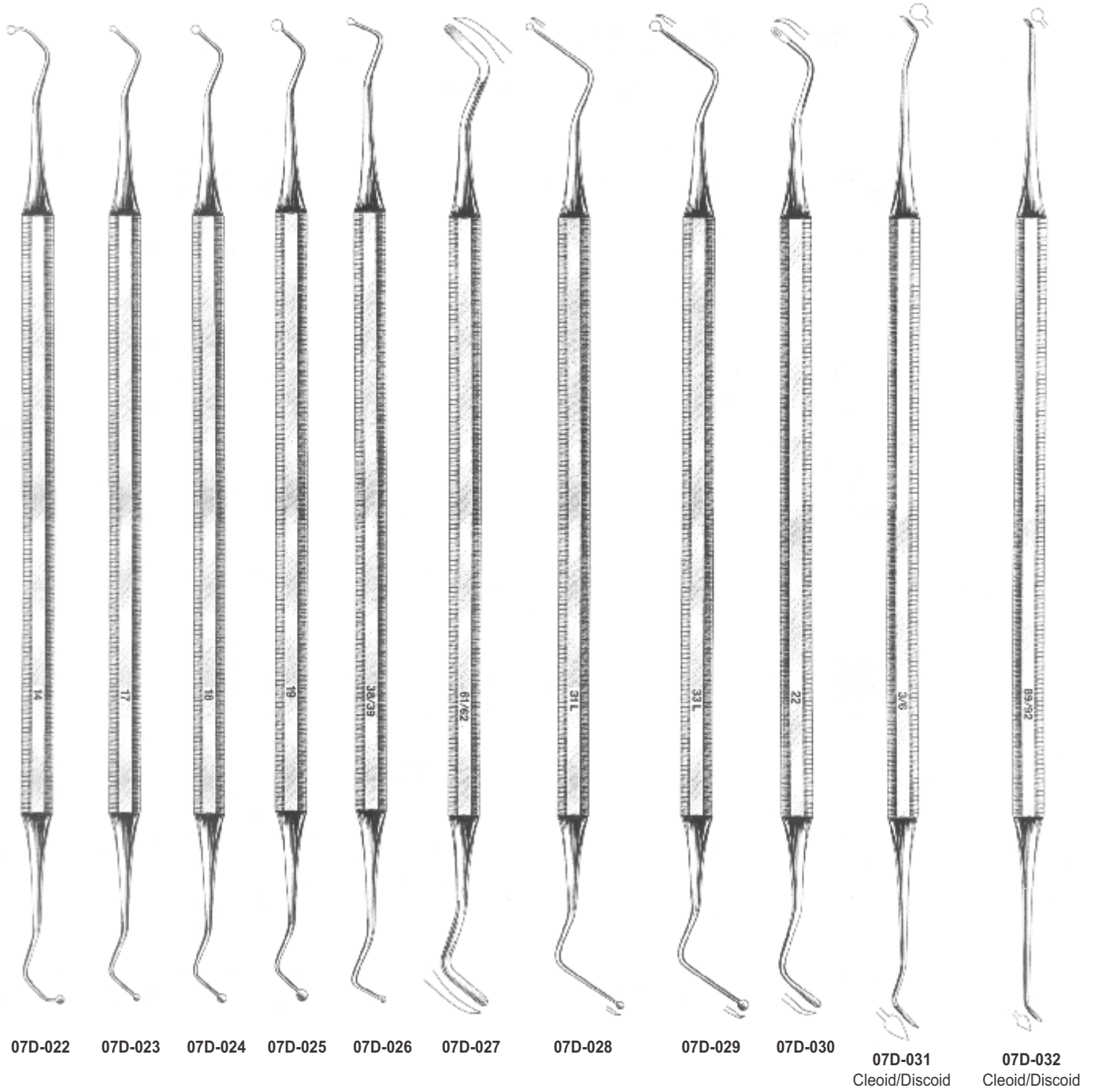



07D

### BURNISHERS

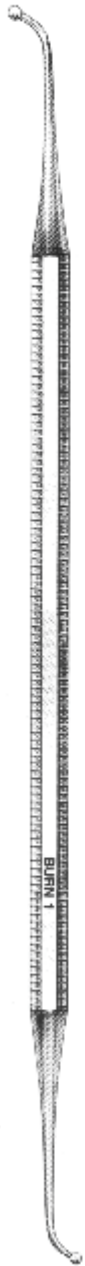

07D-033

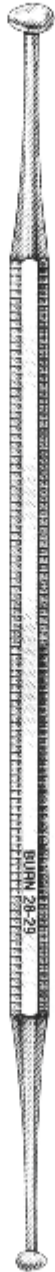

07D-034

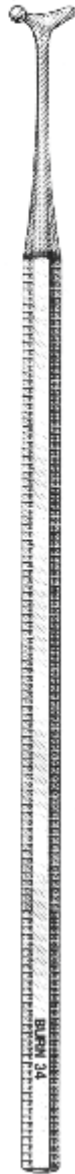

07D-035



07D-036

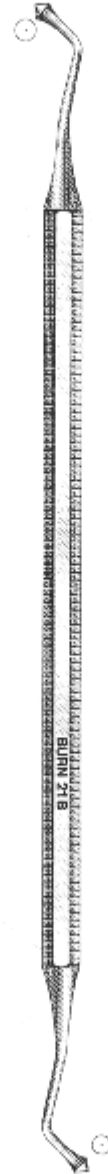

07D-037

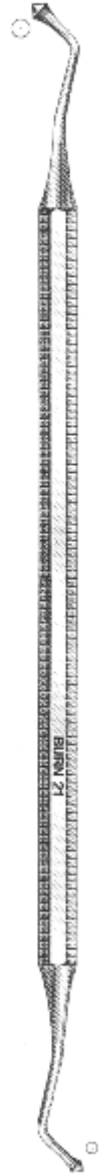

07D-038



07D

EXPLORERS

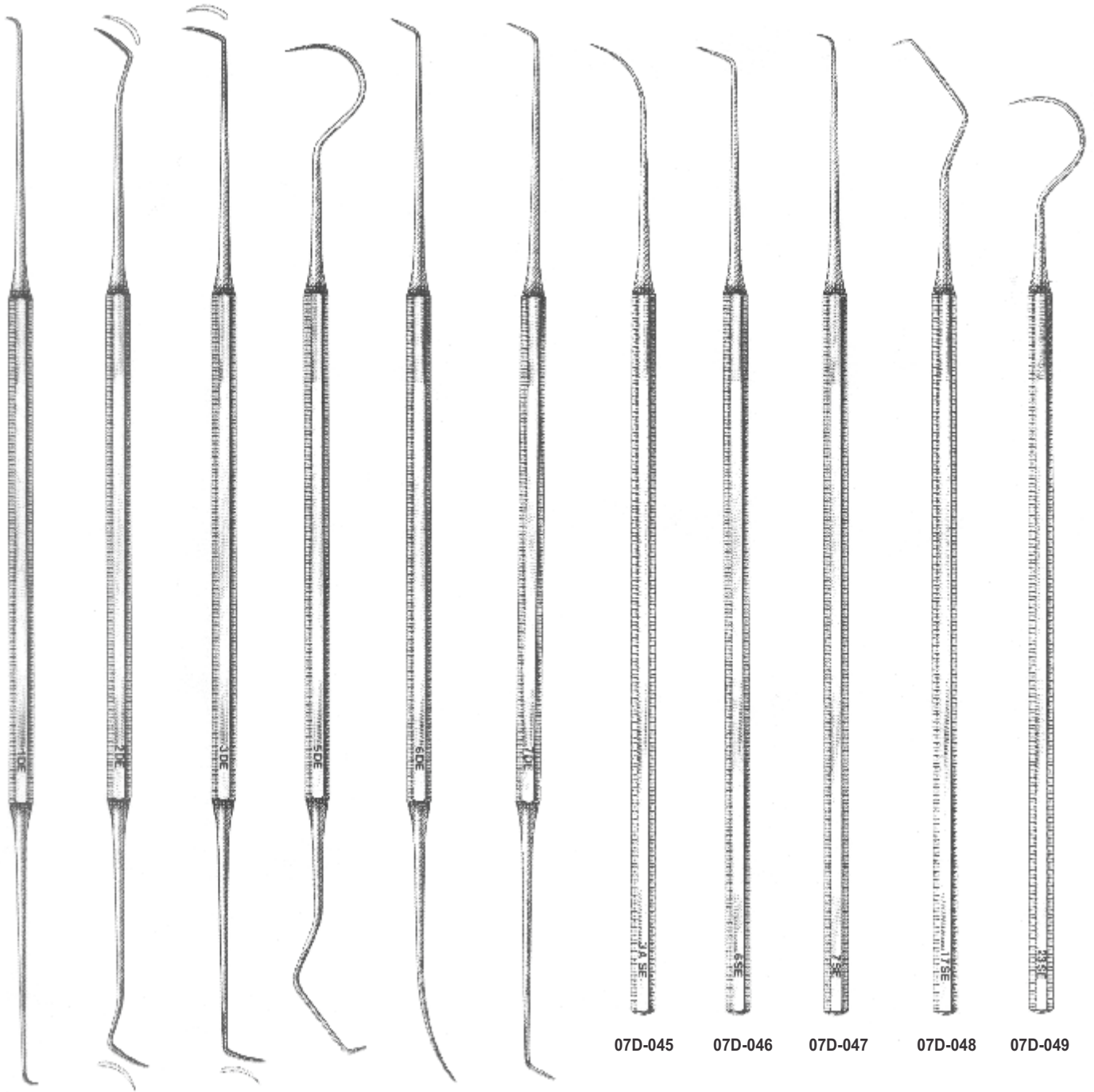

07D-039

07D-040

07D-041

07D-042

07D-043

07D-044

07D-045

07D-046

07D-047

07D-048

07D-049





**PROBES, EXPLORERS, CEMENT SPATULAS**

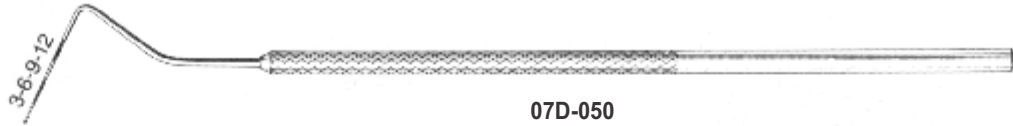

07D-050

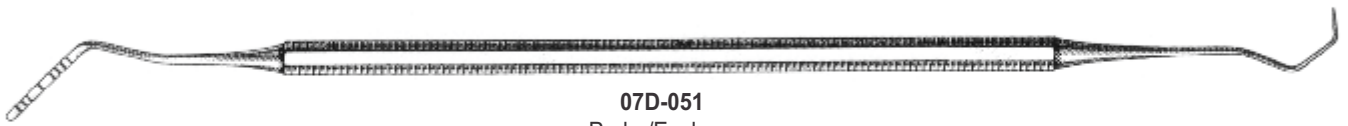

07D-051  
Probe/Explorer

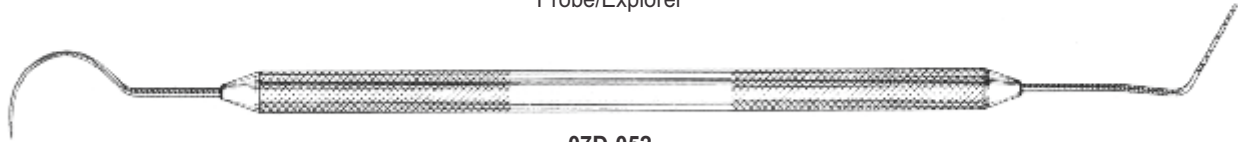

07D-052  
Probe/Explorer

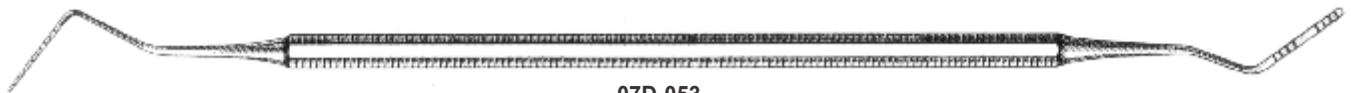

07D-053  
Probe



07D-054  
C-313

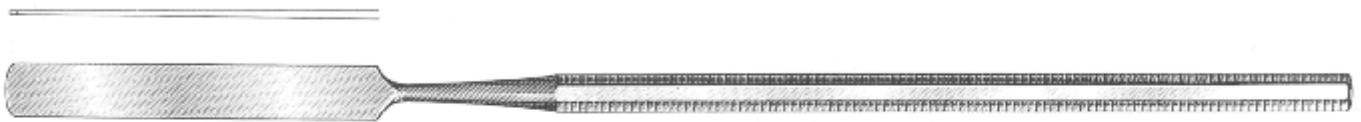

07D-055



07D-056



07D-057

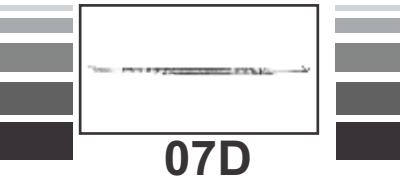

07D

### BONE FILES

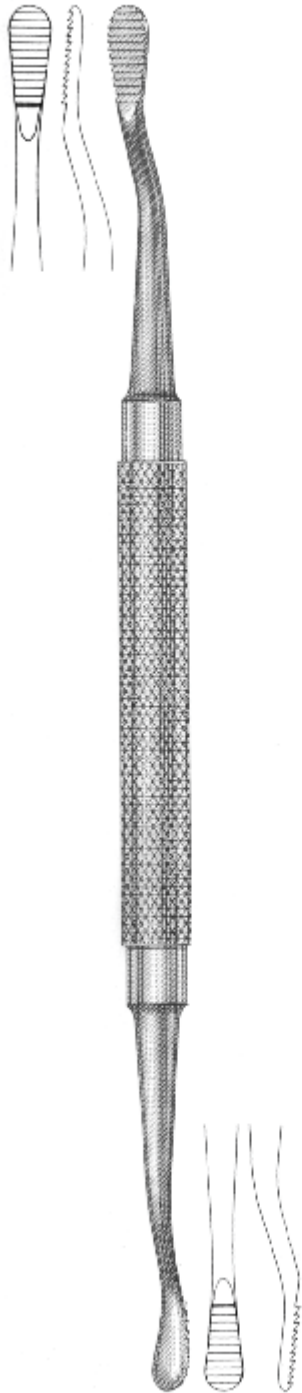

07D-058  
Howard

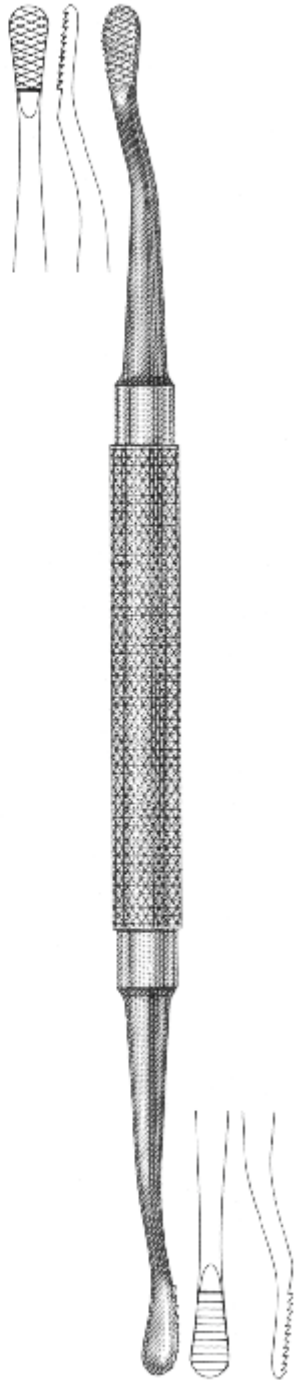

07D-059  
Howard

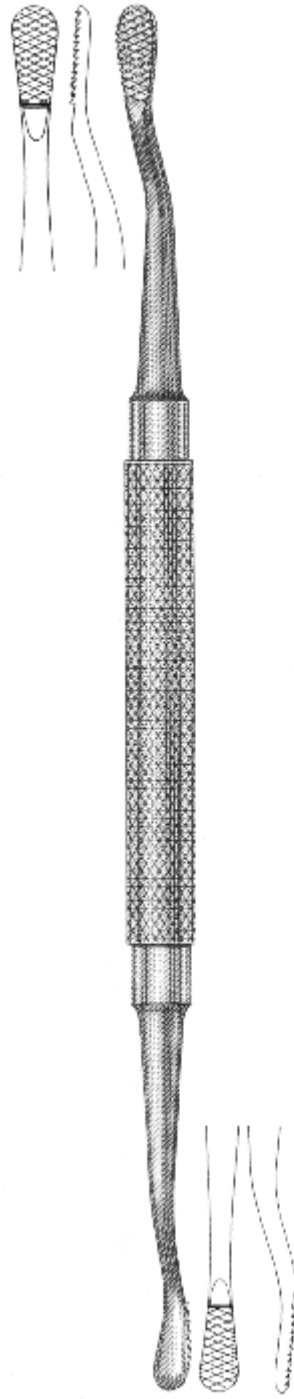

07D-060  
Howard

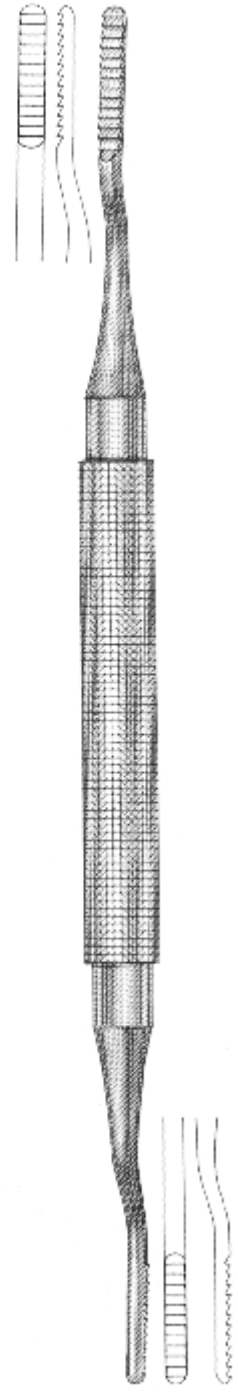

07D-061  
Polokoff

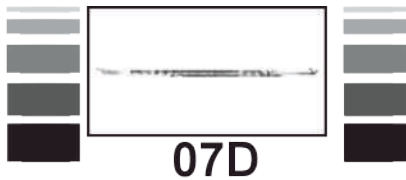

07D

## BONE CHISELS



07D-062  
Gardner



07D-063  
Gardner



07D-064  
Gardner

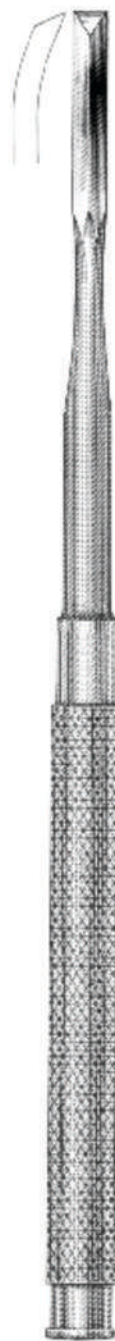

07D-065  
Gardner



07D-066  
Wakefield



07D-067  
Wakefield

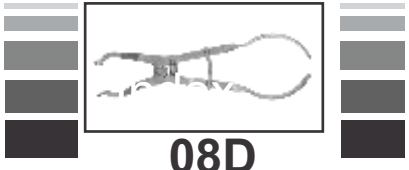

# RUBBER DAM FORCEPS & CLAMPS

08D



**08D-001**  
Brewer Rubber Dam Forceps



**08D-002**  
University of Washington Rubber Dam Clamp Forceps



**08D-003**  
IV Type Rubber Dam Clamp Forceps

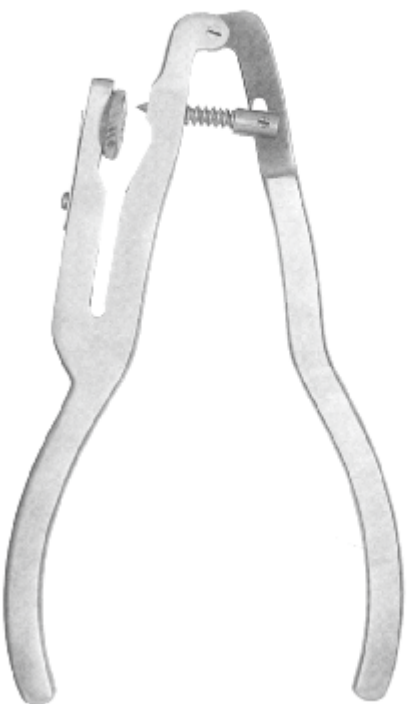

**08D-004**  
IV Type Rubber Dam Punch



**08D-005**  
Ainsworth Rubber Dam Punch



**08D-006**  
Rubber Dam Frame



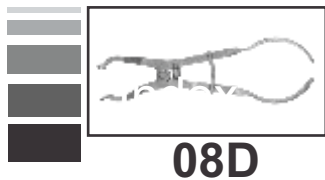

# RUBBER DAM FORCEPS & CLAMPS



## RUBBER DAM CLAMPS

### LOWER MOLARS

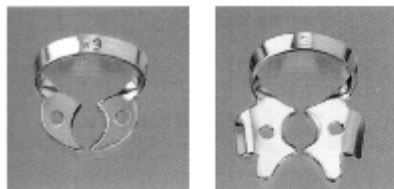

08D-007



08D-008



08D-009



08D-010



08D-011



08D-012



08D-013



08D-014



08D-029



08D-030



08D-031



08D-032



08D-033



08D-034



08D-035



08D-036



08D-037



08D-038



08D-039

### UPPER MOLARS



08D-015



08D-016



08D-017



08D-018

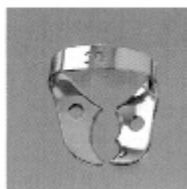

08D-019



08D-020



08D-021



08D-022

### MOLARS

### PRE MOLARS



08D-023



08D-024



08D-025



08D-026



08D-027



08D-028

### ANTERIOR



08D-040



08D-041

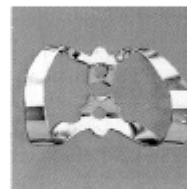

08D-042

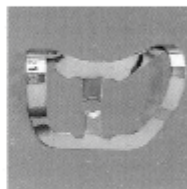

08D-043



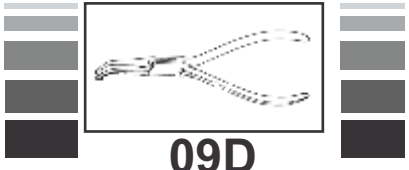

# PLIERS



09D



**09D-001**  
Pesso  
5½" (14 cm)

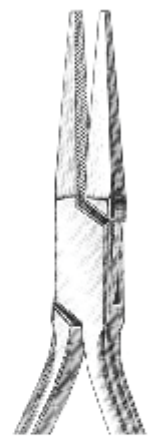

**09D-002**  
Lab and Office



**09D-003**  
Round Nose Plier  
5½" (14 cm)



**09D-004**  
Langenbeck  
Round Nose Plier  
5½" (14 cm)



**09D-005**  
Also Suitable for  
Jaraback Technic 5½"  
(14 cm)



**09D-006**  
5 ⅞" (13 cm)



**09D-007** Angle  
for wire up to 0.7 mm  
diam 5" (12,5 cm)



**09D-008** Adams  
5" (12,5 cm)



**09D-009**  
Frevort  
5" (12,5 cm)

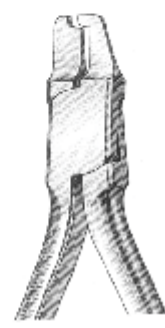

**09D-010**  
417-Crown and Shell

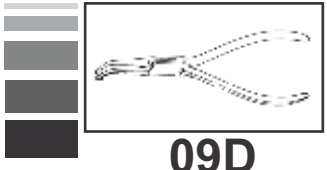

# PLIERS

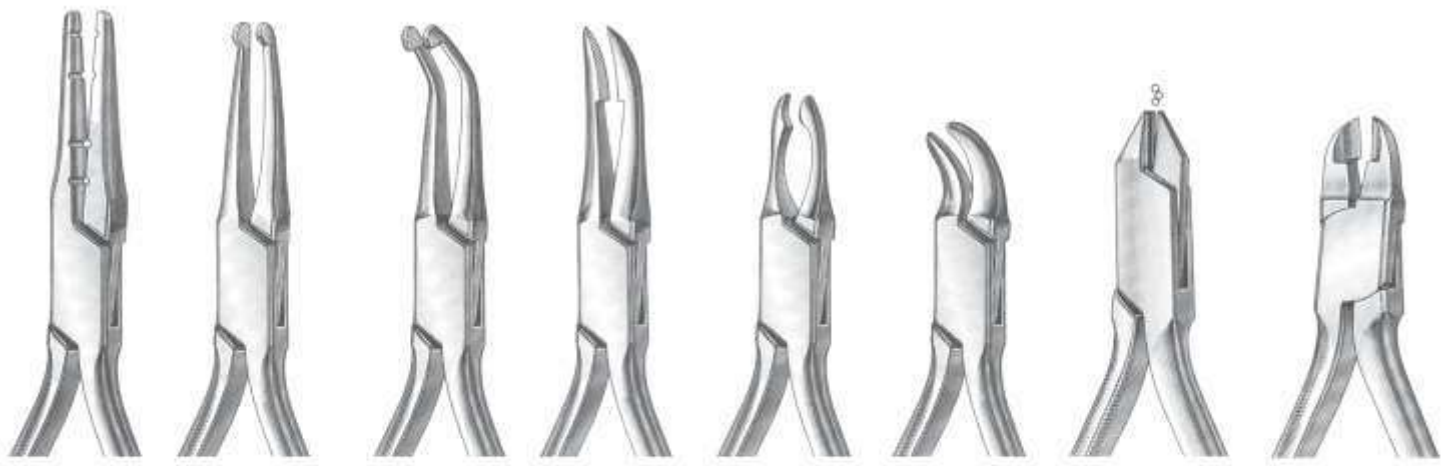

**09D-011**  
Wire Bending

**09D-012**  
How Crown, Straight

**09D-013**  
How Crown, Curved

**09D-014**  
Weingart, Utility

**09D-015**  
Johnson, Contouring

**09D-016**  
Reynolds, Contouring

**09D-017**  
Clasp Adjusting

**09D-018**  
Carbide Tipped Ligature Cutter



**09D-019**  
Universal Plier



**09D-020**  
for wire up to 1.0 mm diam  
6 1/4" (16 cm)



**09D-021**  
Angle Plier  
5 1/8" (13 cm)



**09D-022**  
Angle Plier  
5 1/8" (13 cm)



**09D-023**  
Parallel Action Wire Cutter

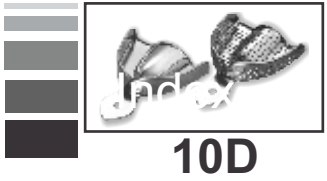

# IMPRESSION TRAYS



## NON PERFORATED

### UPPER

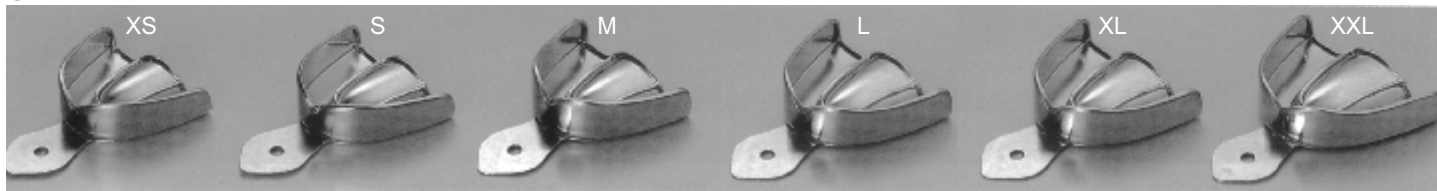

10D-001      10D-002      10D-003      10D-004      10D-005      10D-006

### LOWER

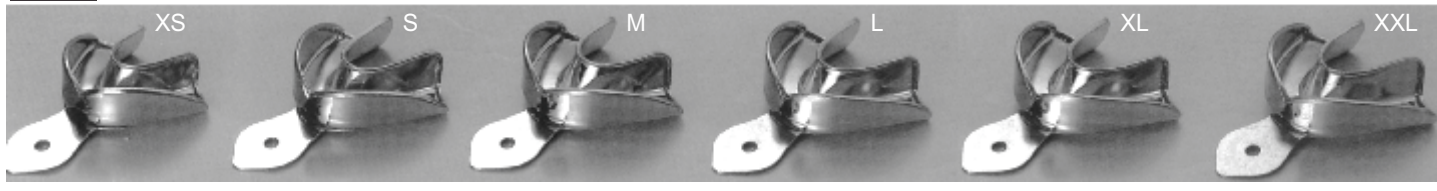

10D-007      10D-008      10D-009      10D-010      10D-011      10D-012



10D-013  
Set of 6pcs

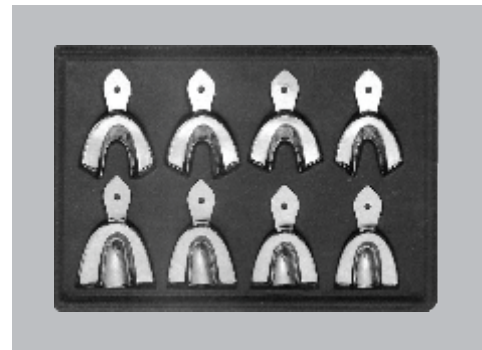

10D-014  
Set of 8pcs

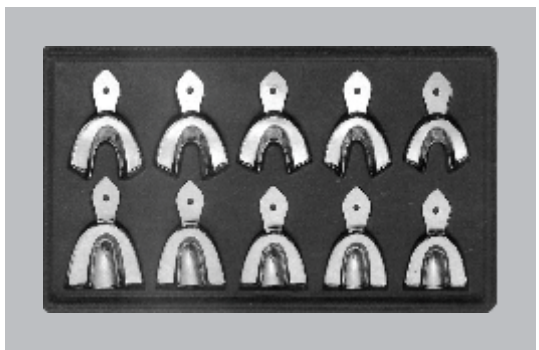

10D-015  
Set of 10pcs

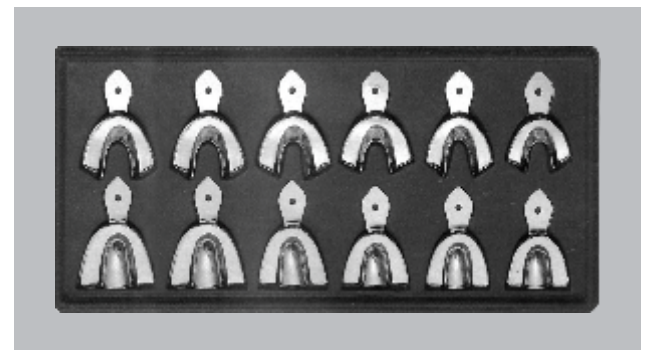

10D-016  
Set of 12pcs

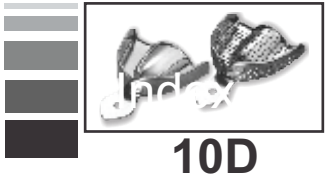

# IMPRESSION TRAYS



## PERFORATED

### UPPER

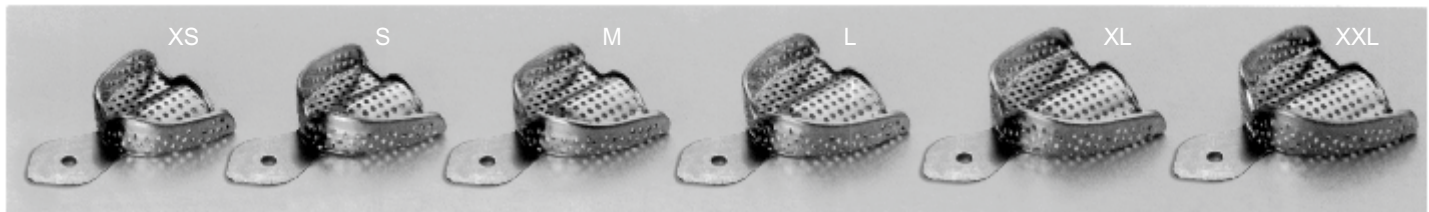

10D-017      10D-018      10D-019      10D-020      10D-021      10D-022

### LOWER

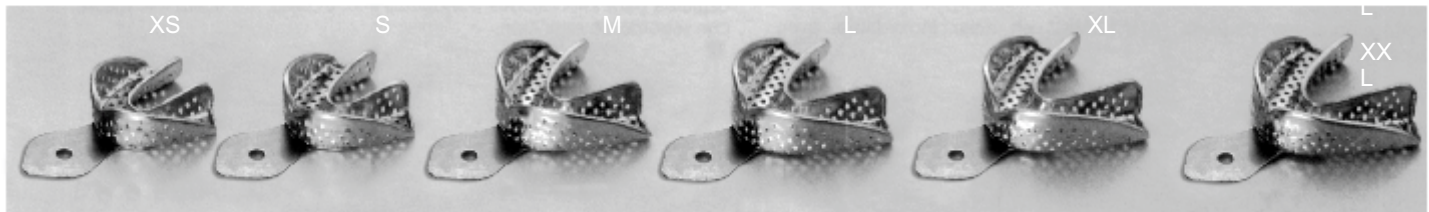

10D-023      10D-024      10D-025      10D-026      10D-027      10D-028



10D-029  
Set of 6pcs

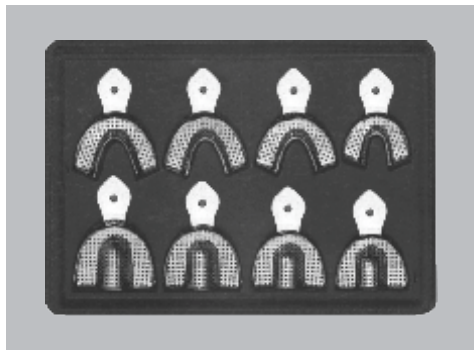

10D-030  
Set of 8pcs

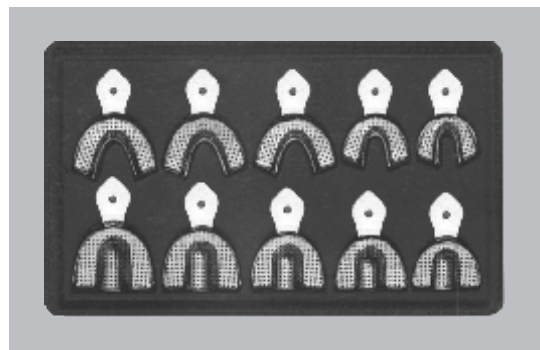

10D-031  
Set of 10pcs

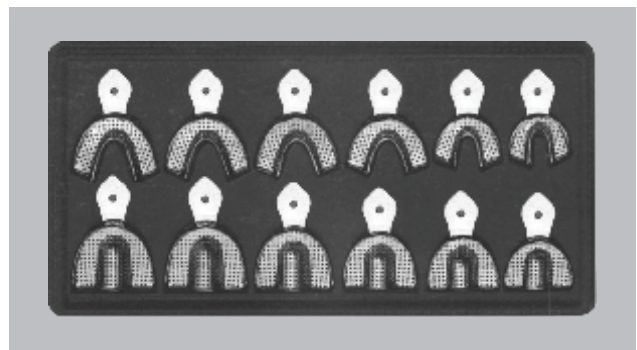

10D-032  
Set of 12pcs





E.M.S

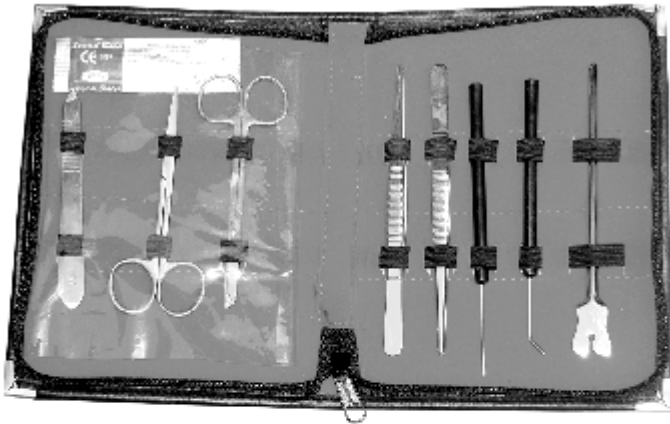

**01E-001**  
Dissecting Set

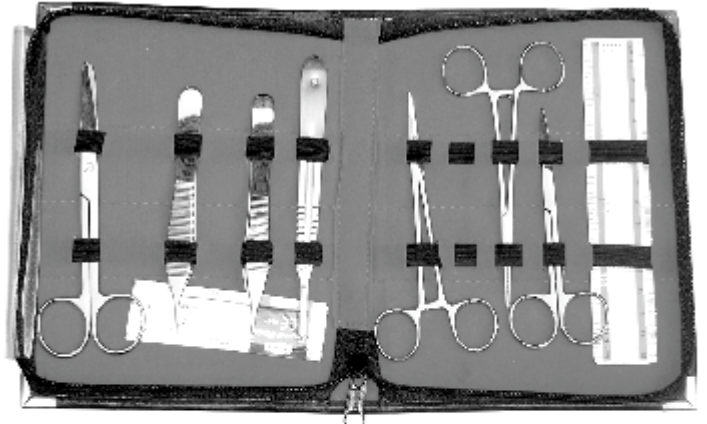

**01E-002**  
Dissecting Set

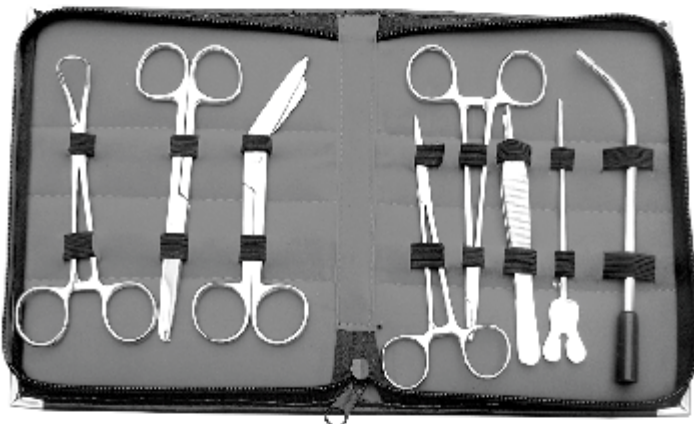

**01E-003**  
Advance Anatomy Dissecting Set



**01E-004**  
Professional Anatomy Dissecting Set



**01E-005**  
Comparative Anatomy Set

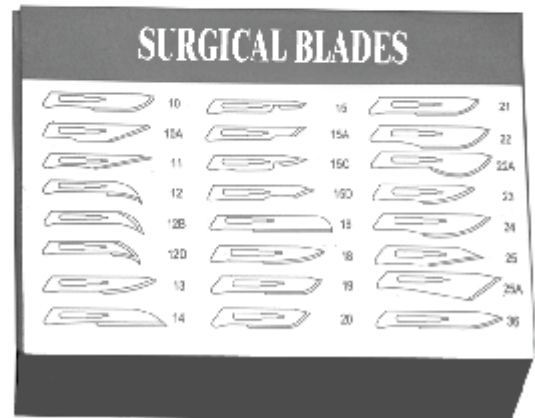

**01E-006**  
Surgical Blade Box of 100 Pcs  
Available # 10, 11, 12, 13, 14, 20,  
21, 22, 23, 24





01E

E.M.S



Macintosh Laryngoscope Set

**01E-007** 3 Blade + 1 Handle

**01E-008** 4 Blade + 1 Handle

**01E-009** 5 Blade + 1 Handle



Macintosh Fiber Optical Laryngoscope Set

**01E-010** 3 Blade + 1 Handle

**01E-011** 4 Blade + 1 Handle

**01E-012** 5 Blade + 1 Handle



Miller Laryngoscope Set

**01E-013** 3 Blade + 1 Handle

**01E-014** 4 Blade + 1 Handle

**01E-015** 5 Blade + 1 Handle



Miller Fiber Optical Laryngoscope Set

**01E-016** 3 Blade + 1 Handle

**01E-017** 4 Blade + 1 Handle

**01E-018** 5 Blade + 1 Handle



**01E-019**

Diagnostic Set

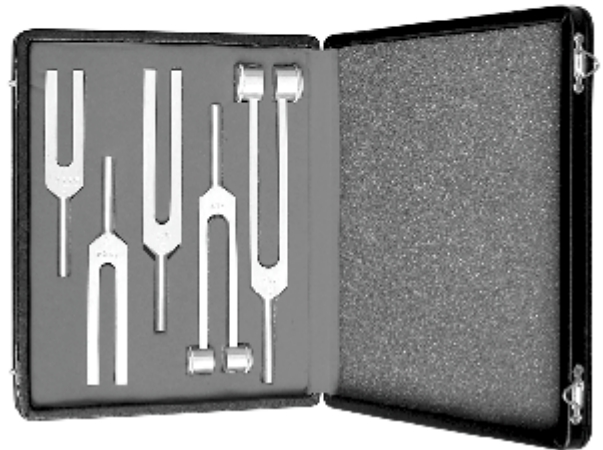

**01E-020**

Tuning Fork Set

Consist:- C128, C256, C512,  
C1024, C2048



01E

E.M.S



**01E-021**  
Sterile Scalpel Handle  
+ Blade (Disposable)



Utility Scissors  

<b>01E-022</b>	7¼"
<b>01E-023</b>	5½"

Note: Mention Color Name After Article #



Black  
Blue  
Red

**01E-024**  
Lister Bandage  
Scissors 5½" with  
Plastic Ring

Note: Mention Color Name After Article #



**01E-025**  
Lister Bandage  
Scissors 5½"  
with Clip

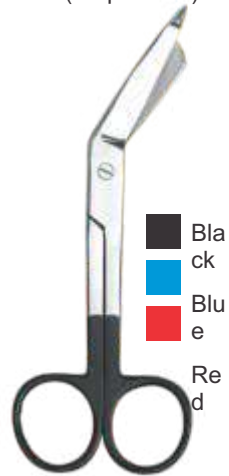

Black  
Blue  
Red

**01E-026**  
Lister Bandage Scissors 5½"

Note: Mention Color Name After Article #

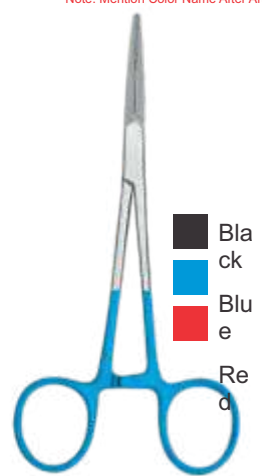

Black  
Blue  
Red

**01E-027**  
Kelly Forceps 5½"

Note: Mention Color Name After Article #

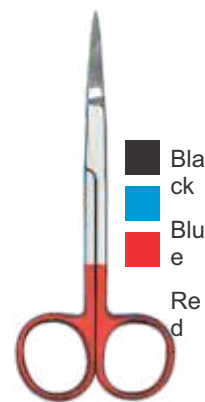

Black  
Blue  
Red

**01E-028**  
Iris Scissors 4½"

Note: Mention Color Name After Article #



Black  
Blue  
Red

**01E-029**  
Splinter Forceps 4½"

Note: Mention Color Name After Article #



**01E-030**  
Lister Bandage  
Scissors 3½" Full Gold



**01E-031**  
Rabiner Hammer



**01E-032**  
Taylor Hammer



**01E-033**  
Buck Hammer



**01E-034**  
Pin Wheel



**01E-036**  
Ring Cutter



**01E-035**  
Ring  
Cutter  
Spare  
Blade

**01E-037**  
Ring Cutter with Safety Cap



**01E-038**  
Young Tongue Forceps



Magil Forceps  

<b>01E-039</b>	6"
<b>01E-040</b>	8"
<b>01E-041</b>	10"
<b>01E-042</b>	11"



01E

# E.M.S



**01E-043**  
Sterile  
Disposable  
Syringe Box of  
100 Pcs



**01E-044**  
Pen Light with Pupil  
Gauge Set of 6 Pcs



**01E-045**  
Thermometer Digital



**01E-046**  
Thermometer  
Dual Mercury  
Scale



**01E-047**  
Window Puncher



**01E-049**  
Sterile Latex Gloves  
Box of 12 Pcs



**01E-048**  
Stethoscopes



Glass Jar with Lid

<b>01E-050</b>	3 x 3
<b>01E-051</b>	7 x 4
<b>01E-052</b>	7 x 3
<b>01E-053</b>	6 x 6
<b>01E-054</b>	5 x 5
<b>01E-055</b>	4 x 4



**01E-056**  
Mayo Post  
Stand (Single  
Post)



**01E-057**  
Mayo Post  
Stand  
(Double  
Post)





**01V**

**VETERINARY INSTRUMENTS**

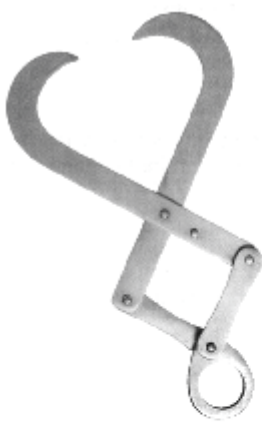

**01V-001**  
Krey  
Schottler  
XL



**01V-002**  
Harms OB  
Hook



**01V-003**  
Rugebergs  
Spring Type  
OB Double  
Eye Hook



**01V-004**  
Vienna Double Blunt  
Eye Hook 14 cm

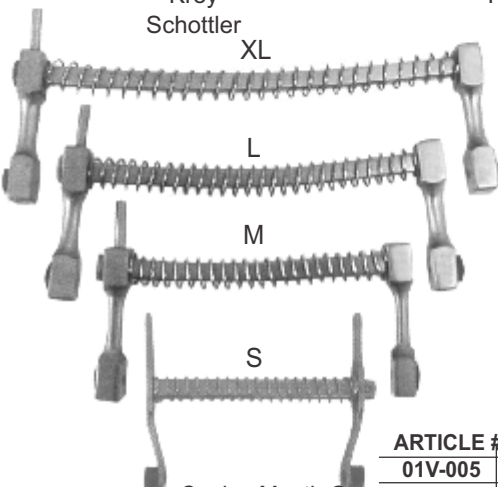

Canine Mouth Gag

ARTICLE #	SIZE
01V-005	S
01V-006	M
01V-007	L
01V-008	XL

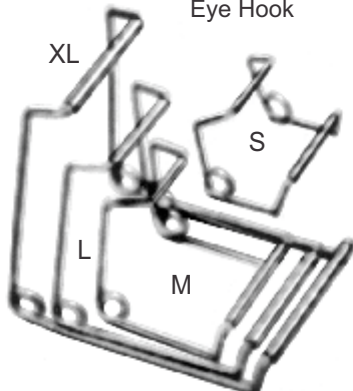

Smith Baxter Mouth Gag

ARTICLE #	SIZE
01V-009	S
01V-010	M
01V-011	L
01V-012	XL



**01V-013**  
Hoof Knife, Left



**01V-014**  
Hoof Knife, Right

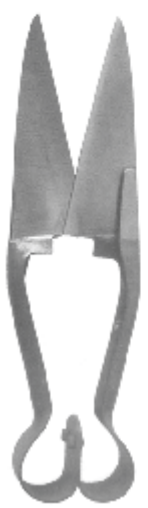

**01V-015**  
Sheep Trimming  
Shears



**01V-016**  
White's Tonsil  
Scissors 4"



**01V-017**  
Molar  
Cutter



**01V-018**  
Molar Extraction  
Forceps



**01V-019**  
Sheep Balling Gun  
31,5 cm



**01V-020**  
Drench  
Pump



**01V**

**VETERINARY INSTRUMENTS**



**01V-021**  
Bull Leap (Spring Loaded) 11 cm

**01V-030**  
Hauptner Hoof Tester 14½"



**01V-022**  
Bull Lead



**01V-031**  
Standard Hoof Tester 13"



**01V-023**  
Harm's Style Bull Lead 18 cm



**01V-032**  
Adjustable Hoof Tester

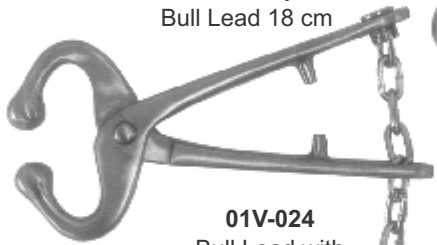

**01V-024**  
Bull Lead with Chain 22 cm



**01V-025**  
Bull Lead without Chain 22 cm



**01V-033**  
Large Hoof Tester 13"



**01V-034**  
Steel Hoof Trimmer

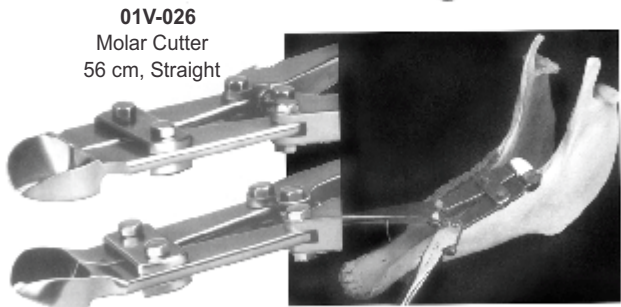

**01V-026**  
Molar Cutter 56 cm, Straight

**01V-035**  
Hoof Trimmer 20"

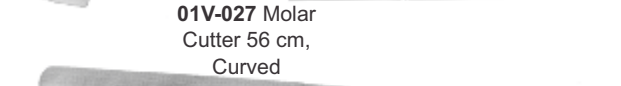

**01V-027**  
Molar Cutter 56 cm, Curved

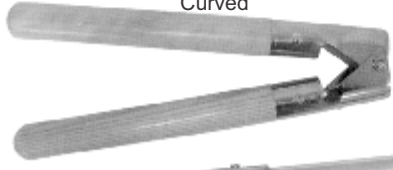

**01V-028**  
Barne's Dehorner 12"



**01V-036**  
Ryding Hoof Tester

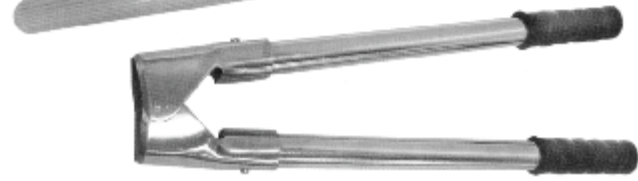
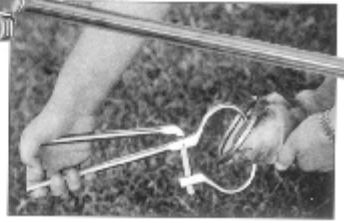

**01V-029**  
Dehorner Heavy Duty 17"





**01V**

**VETERINARY INSTRUMENTS**

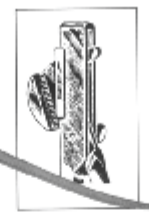
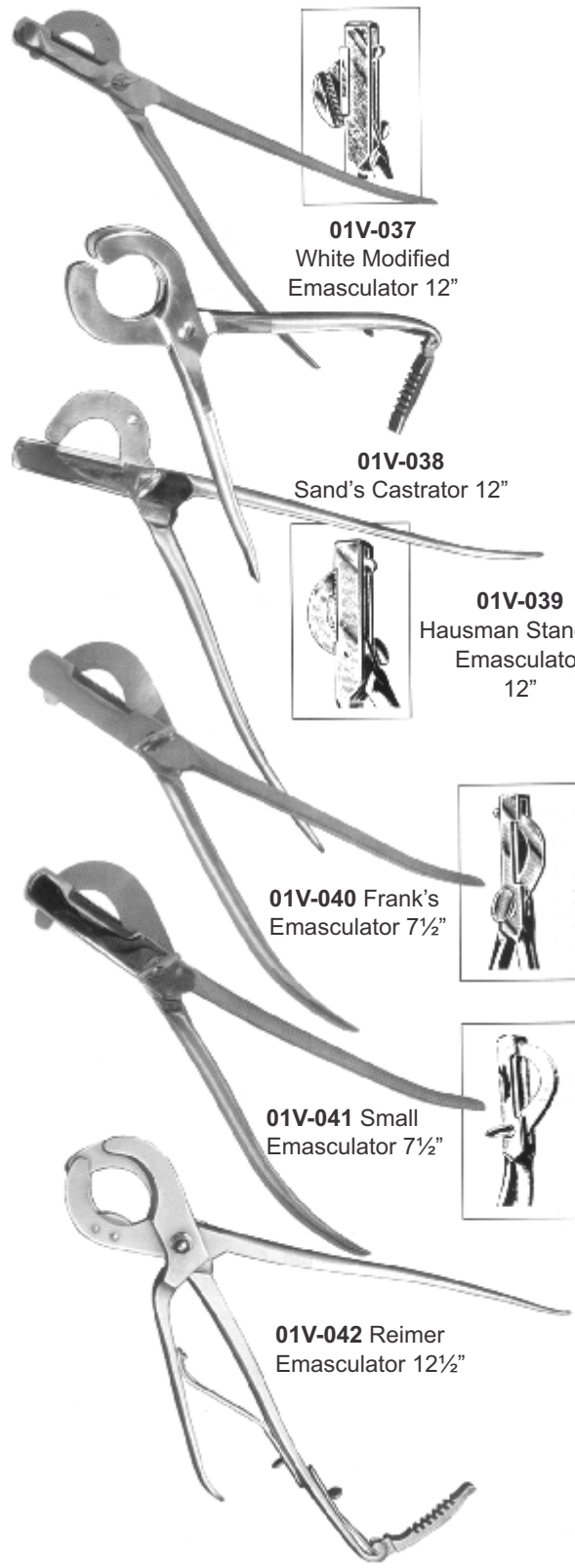

**01V-037**  
White Modified  
Emasculator 12"



**01V-039**  
Hausman Standard  
Emasculator  
12"



**01V-040** Frank's  
Emasculator 7½"



**01V-041** Small  
Emasculator 7½"

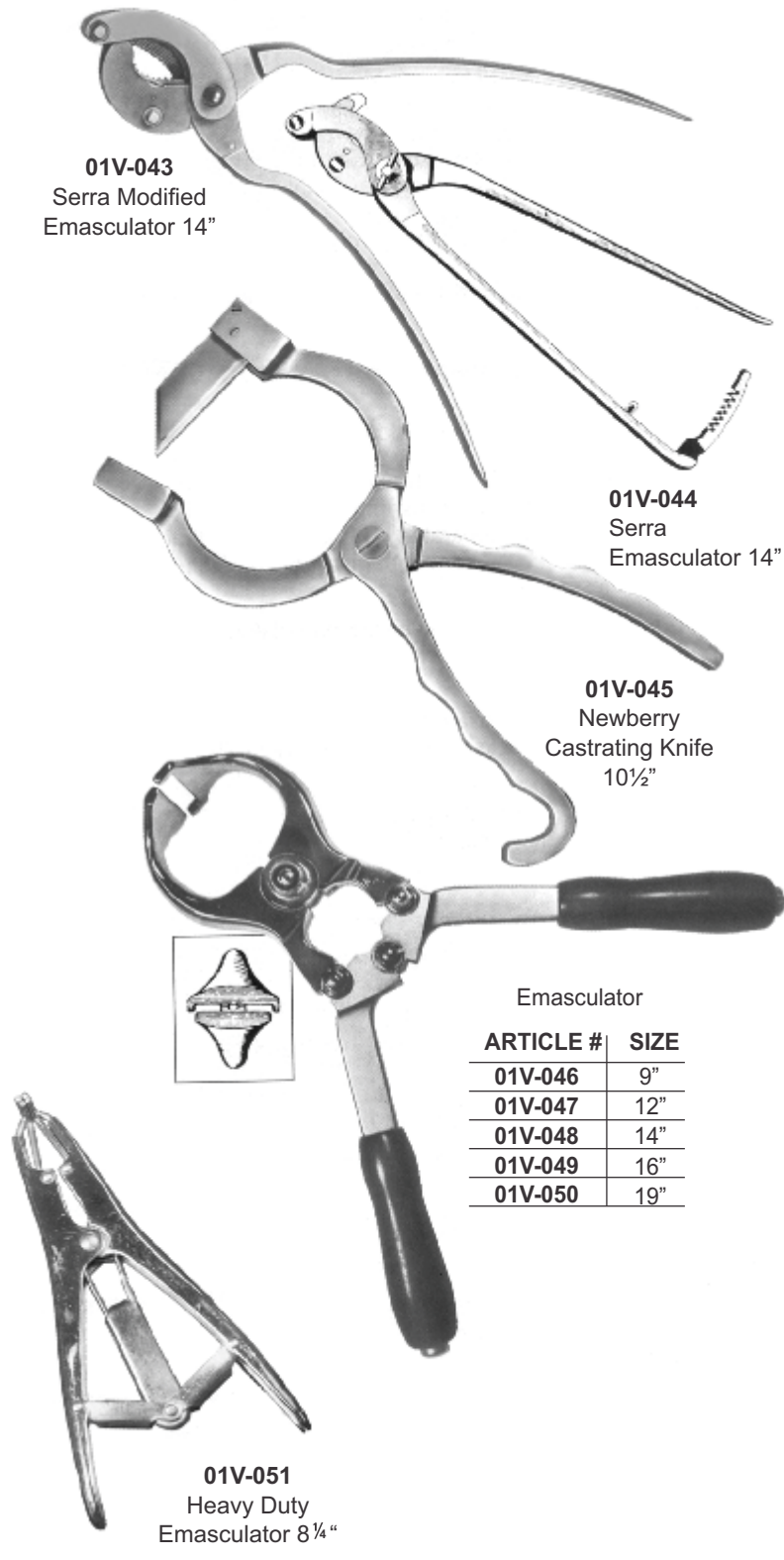

**01V-043**  
Serra Modified  
Emasculator 14"

**01V-044**  
Serra  
Emasculator 14"

**01V-045**  
Newberry  
Castrating Knife  
10½"



**01V-051**  
Heavy Duty  
Emasculator 8¼"

Emasculator

ARTICLE #	SIZE
01V-046	9"
01V-047	12"
01V-048	14"
01V-049	16"
01V-050	19"



# DIAGNOSTIC INSTRUMENTS



Mini Fiber Optic /  
Conventional Otoscope  
A



Diagnostic Set



Tongue Depressor Holders  
A



Clip Lamp illuminator  
A

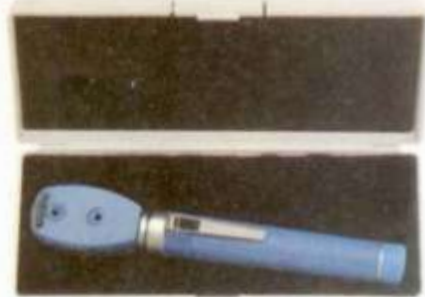

Mini Ophthalmoscope

# INDEX

<b>A</b>		Page	<b>D</b>		Page
ADAM PLIER		138	DAHLGREN INSTRUMENTS		55
ADJUSTABLE HOOF TESTER		147	DANDY HEMOSTATIC FORCEPS		6
ADSON BROW FORCEPS T.C		101	DAVIS BOYLE MOUTH GAG		37
ADSON BROWN FORCEPS		18	DE VIBISS INSTRUMENTS		55
ADSON FORCEPS		18	DE-BAKEY DRESSING FORCEPS DE-		95
ADSON FORCEPS MICRO T.C		101	BAKEY FORCEPS		95, 96
ADSON FORCEPS LASER		111	DE-BAKEY SCISSORS		17
ADSON FORCEPS T.C		101	DE-BAKEY VASCULA DILATOR		76
ADSON HEMOSTATIC FORCEPS		6	DEJERINE PERCUSSION HAMMER		2
ADSON NEEDLE HOLDER		24	DELEE RETRACTOR		31
ALCOHAL LAMP		112	DENHARDT MOUTH GAG		36
ALLIS TISSUE FORCEPS		10	DENIS BROWN ABDOMINA RETRACTOR		34
ALLIS TISSUE FORCEPS LASER		111	DERF NEEDLE HOLDER		23
ALM RETRACTOR		32	DESMARRESS CHALLAZION FORCEPS		88
AMALGAM CARRIER		123	DESMARRESS LID RETRACTOR		85
AMALGAM CARRIER SWISS PATTERN		123	DESMARRESS RETRACTOR		27
ANATOMY DISSECTING SET ADVANCE		142	DEVER RETRACTOR		28
ANATOMY DISSECTING SET PROFESSIONAL		142	DIAGNOSTIC SET		142
ANGLE PLIER		138	DIAMANT WIRE CUTTING PLIER		73
ANGLE PLIER T.C		139	DILATOR'S		76
ARRUGA NEEDLE HOLDER		94	DINGMANN BONE FORCEPS		63
ARTERY FORCEPS SPENCERWELL		7	DISPOSABLE SYRINGE STERILE		145
ARTICULATING PAPER FORCEPS		126	DISSECTING SET		142
ASPIRATION SYRING		124	DITTEL SOUND		76
AUFRICHT CURETTE		50	DOYEN ABDOMINAL SCISSORS		17
AUVARD VAGINAL SPECULUM		77	DOYEN BIOPSY FORCEPS		81
AYER CHALAZION FORCEPS		8	DOYEN HAMMER		62
<b>B</b>			DOYEN VAGINAL SPECULA		78
BABCOCK FORCEPS		10	DRENCH PUMP		146
BABY MIXTER ARTERY FORCEPS		8	DRESSING FORCEPS		19
BACKHAUS TOWEL CLAMP		12	DRESSING FORCEPS T.C		102
BACKHAUS TOWEL CLAMP LASER		110	DRESSING SCISSORS T.C		97
BAILEY RIB CONTRACTORS		54	DURANTE TISSUE FORCEPS		21
BALFOUR CENTER		33	DUVAL TISSUE FORCEPS		21
BLADE BALFOUR RETRACTOR		33	<b>E</b>		
BALL & SOCKET TOWEL CLAMP		12	EXTRACTING FORCEPS		115 TO 117
BALL CHAIN		125	ANGLE CAST SAW		67
BALLENGER SPETUM KNIVES		48	EAR FORCEPS		41 TO 46
BALLING GUN		146	EAR SPECULUM		40
BANDAGE SCISSORS		16	EAR SYRINGE		40
BANGOLEA HEMOSTATIC FORCEPS		9	ECHLIN BONE RONGUER		69
BARRAQUER EYE SPECULUM		86	ELASTRATOR		148
BARRAQUER NEEDLE HOLDER		93	ELDCHING FIXATION FORCEPS		89
BARRAQUER SCISSORS		90	ELEVATORS		118 TO 121
BARRETT TENACULUM FORCEPS		74	EMASCULATOR		133
BARRON SUCTION TUBE		49	EMISES BASIN		114
BARTH EAR CURETTE		45	EPPENDORF BIOPSY FORCEPS		81
BASIN EMISES		114	ERHARDT CHALAZION FORCEPS		88
BAUMGARTNER NEEDLE HOLDER		23	EVANS TISSUE FORCEPS		103
BAYONET FORCEPS T.C		101	EXCAVATORS		130
BECKMANN NASAL SPECULUM		38	EXPLORER		132
BEDPAN AMERICAN TYPE		114	<b>F</b>		
BEDPAN SLIPER TYPE		114	FARABEUF BONE HOLDING FORCEPS		66
BELLUCCI MICRO EAR FORCEPS		42	FARABEUF LAMBOTTE BONE HOLDING		66
BILLEAU EAR FORCEPS		45	FORCEPS FARABEUF RETRACTOR		27
BIRCHER GANSKE FORCEPS BISHOP		63	FERGUSSON BONE HOLDING FORCEPS		64
HARTMAN FORCEPS BLADE BREAKER		88	FERRIS SMITH KERISION RONGUER		57
BLADES B.P HANDLE		94	FINOCHIETOO RIB SPREADERS		53
BLUEMENTHAL BONE RONGUER		142	FISCH EAR INSTRUMENTS		46
BOLEY GUAGE		68	FLAT NOSE PLIER		72, 73
BOLT CUTTER		126	FOERSTER SPONG FORCEPS		11
BONE & RIB SHEARS		72	FORCEPS JAR		112
BONE CHISEL		50	FRAZIER DURA HOOK		26
BONE CUTTER T.C		61, 135	FRAZIER SUCTION TUBE		49
BONE FILE		107	FRENCH LAMINECTOMY SPREADERS		54
BONE GOUGE		134	FREVERT PLIER		138
BONE HAND DRILL		61	FRITSCH RETRACTOR		31
BONE HOLDING FORCEPS		58	FROSCH BONE HOLDING FORCEPS		64
BONE RONGUERS		63, 64			
BONNEY TISSUE FORCEPS		68, 69			
BONNEY TISSUE FORCEPS T.C		21			
BOZEMAN FORCEPS LASER		109			
BOZEMAN UTERINE DRESSING FORCEPS		74			
BRAUN STADLER SCISSORS		17			
BROWN NEEDLE HOLDER		23			
BRUNNER STERNUM SCISSORS		52			
BRUNS BONE CURETTE		60			
BRWEER RUBBER DAM FORCEPS		136			
BUCK EAR CURETTE		45			
BUCK EAR FORCEPS		44			
BUCK PERCUSSION HAMMER		2, 142			
BUCKET		113			
BUCKET KICK STAND		145			
BULL LEAD		145			
BULL RINGS		53			
BURFORD-FINOCHITOO RIB SPREADERS		82			
BURKE BIOPSY FORCEPS		131			
BURNISHERS					
<b>C</b>					
CAMPION LASER FORCEPS		109			
CANINE MOUTH GAG		146			
CARHALT SPLINTER FORCEPS		22			
CARMALT FORCEPS		7			
CASPER RETRACTOR FOR SPINE		54			
CAST SPREADER 3PRONG		67			
CASTROVIEJO BLADE BREAKER		94			
CASTROVIEJO CALIPER		86			
CASTROVIEJO CORNEAL SCISSORS		91			
CASTROVIEJO FIXATION FORCEPS		89			
CASTROVIEJO KALT NEEDLE HOLDER		94			
CASTROVIEJO NEEDLE HOLDER		92			
CASTROVIEJO SCISSORS		90			
CASTROVIEJO SPATULA		85			
CATHITER TRAY		112			
CATRIDGE SYRING		124			
CEMENT SPATULA		133			
CHARRIERE RESECTION SAW		59			
CHARRIERE SAW		59			
CLASP ADJUSTING PLIER		139			
CLEVELAND BONE CUTTING FORCEPS		71			
CLIP APPLYING FORCEPS		56			
CLOWARD LAMINA SPREADERS		55			
COLIBRI FORCEPS		87			
COLLEGE TWEEZER		126			
COLLIER NEEDLE HOLDER		23			
COLLIN ABDOMINAL RETRACTOR		33			
COLLIN CLAMP		83			
COLLIN DUVAL GRASPING FORCEPS		21			
COLLIN HAMMER		62			
COLLIN VAGINAL SPECULUM		77			
COLLIN TONGUE FORCEPS		35			
COLOUMBIA RETRACTOR		36			
COLUMBIA CURETTE		128			
CONE RETRACTOR		32			
COOLEY RIB SPREADERS		53			
COTTLE CURETTE		50			
COTTON WOOL CONTAINER		113			
COTTON WOOL DISPENSER		112			
CRILE HEMOSTATIC FORCEPS		5			
CRILE MURRAY NEEDLE HOLDER		24			
CRILE NEEDLE HOLDER		25			
CRILE RANKIN HEMOSTATIC FORCEPS		5			
CRILE WOOD NEEDLE HOLDER		24			
CROWN & SHELL REMOVING PLIER		138			
CROWN GUAGE		125			
CRUSH EMASCULATOR		148			
CRUTCHFIELD TRACTION		55			
CUSHING DRESSING / TISSUE FORCEPS		20			
CUSHING DRESSING FORCEPS T.C		102			
CUSHING LAMINECTOMY RONGUERS		57			
CUSSCO VAGINAL SPECULUM		77			
CUZZI SPOON		84			





# INDEX

MOD USA DRESSING FORCEPS T.C	103	<b>R</b>	
MODIFIED EMASCULATOR	148	RABINER NEUROLOGICAL HAMMER	2, 144
MOLAR CUTTER	50, 146	RAGNELL DAVIS RETRACTOR	26
MOLAR EXTRACTION FORCEPS	146	RAMPLEY SPONG FORCEPS	11
MOORE HAND DRILL	58	RANEY CLIP APPLYING FORCEPS	56
MOORFIELD FIXATION FORCEPS	89	REMIER EMASCULATOR RETRACTORS	148
MORSE RETRACTOR	26	REYNOLDS CONTOURING PLIER	26 TO 34
MOSQUITO FORCEPS	4	RIB CONTRACTORS	139
MOSQUITO FORCEPS BABY	4	RIB SHEARES	54
MOUTH GAG	36	RIB SPREADERS	52
MULI ELEVATOR	121	RICHARDSON EASTMAN	53
MUSEUX TENACULUM FORCEPS	74	RETRACTOR RING CUTTER	27
		RING CUTTER WITH SAFETY CAP	144
		ROCHESTER CARMALT FORCEPS	144
		ROEDER TOWEL CLAMP	7
		ROOT TIP PICK ELEVATOR	12
<b>N</b>		ROSEN EAR INSTRUMENTS	119
NAEGELE OBSTETRICAL FORCEPS	84	ROSER KORING MOUTH GAG	46
NASAL SPECULUM	38, 39	ROUX RETRACTOR	36
NEEDLE HOLDER T.C	104	ROUX RETRACTOR MINI	27
NEEDLE HOLDERS	23 TO 25	RUBBER DAM CLAMPS	27
NEIVERT NEEDLE HOLDER	23	RUBBER DAM CLAMP FORCEPS	137
NEWBERRY CASTRATING KINFE	146	RUBBER DAM FRAME	136
NOSE PLIER	138	RUBBER DAM PUNCH	136
NOYES IRIS SCISSORS	90	RUGGEBERG SPRING TYPE EYE HOOK	146
<b>O</b>		RUSKIN BONE CUTTING FORCEPS	70
O,SULLIVAN-O CONNOR RETRACTOR	33	RUSKIN BONE RONGUER	69
OEHLER TISSUE FORCEPS T.C	102	RUSKIN LISTON BONE CUTTING FORCEPS	70
OIMENT JAR	112	RUSS MODELL TISSUE FORCEPS	21
OLIVEERONA TOENNIS	56	RYDEL SEIFFER TUNING FORK	51
OLSEN HEGAR NEEDLE HOLDER	24	RYDING HOOF TESTER	147
OPERATING SCISSORS	13		
OSTERTAGE EYE HOOK	146	<b>S</b>	
		SAENGER FORCEPS	
<b>P</b>		SANDS CASTRATOR	
PAPER FORCEPS	126	SATTERLEE SAW	148
PARALLEL ACTION WIRE CUTTER	139	SAUEBRUCH BONE RONGUER	59
PARAMETRIUM SCISSORS	17	SAUERB-RUCH STERNUM SCISSORS	69
PATON NEEDLE HOLDER	94	SCALPLE BLADES	52
PAUFIQUE SUTURE FORCEPS	89	SCALPLE HANDLE	1
PEDERSON VAGINAL SPECULUM	77	SCHAEDEL TOWEL CLAMP	1
PEERS TOWEL CLAMP	12	SCHAEDEL TOWEL CLAMP	12
PEN LIGHT	145	SCHEDO BONE CURETTE	60
PENINGTON FORCEPS	10	SCHROEDER TENACULUM FORCEPS	74, 75
PERCUSSION HAMMER	2	SCHROEDER TENACULUM FORCEPS LASER	109
PERCY ABDOMINAL RETRACTOR	34	SCHUBERT UTERINE BIOPSY FORCEPS	80
PERIOSTEAL ELEVATOR	120	SCHUKNECHT EAR INSTRUMENTS	46
PESSO PLIER	138	SCHWEIZER FORCEPS LASER	109
PIN CUTTER	76	SCISSORS	13 TO 17
PIN WHEEL	144	SELLHEIN FORCEPS	71
PINARD STETHOSCOPE	3	SEMB BONE CUTTING FORCEPS	66
POLITZER EAR BAG	40	SEMB BONE HOLDING FORCEPS	69
POLITZER EAR SPECULUM	40	SEMB BONE RONGUER	26
POLITZER EAR SPECULUM	111	SENN MULLER RETRACTOR	148
POOTS SMITH DRESSING FORCEPS LASER	102	SERRA MODIFIED EMASCULATOR	45
POOTS SMITH DRESSING FORCEPS T.C	100	SHAPLEIGHY EAR CURETTE	47
POOTS SMITH SCISSORS T.C	120	SHEA CURETTE	146
POTTS ELEVATOR	20	SHEEP TRIMMING SHEARES	84
POTTS SMITH DRESSING FORCEPS	74	SIMPSON BRAUN OPSTETRICAL FORCEPS	84
POZZI TENACULUM FORCEPS	75	SIMPSON OPSTETRICAL FORCEPS	79
PRATT TENACULUM FORCEPS PROBES	3, 133	SIMS UTERINE CURETTE	79
PROVIDENCE HOSPITAL HEMOSTATIC FORCEPS	6	SIMS UTERINE SOUND	79
		SIMS VAGINAL SPECULUM	77
		SINGLEY FORCEPS LASER	111
		SKINNER TISSUE FORCEPS T.C	102
		SMITH BAXTER MOUTH GAG	146
		SNARES	49
<b>Q</b>		SNELLEN EAR FORCEPS	45
QUIRE EAR FORCEPS	44	SPENCERWELL ARTERY FORCEPS	7
		SPLINTER FORCEPS	18
		SPLINTER FORCEPS COLOUR	144
		SPONG FORCEPS	11
		SPRATT BONE CURETTE	60
		STANDARD HOOF TESTER	147
		STERILE SCALPLE HANDLE+BLADE	144
		STERLIZING CONTAINER	114
		STERLIZING DRUM	114
		STERLIZING TRAY STETHOSCOPES	112
		STEVEN NEEDLE HOLDER	145
		STEVEN SCISSORS	94
		STEVENSON LACRIMAL SAC	16
		RETRACTOR STILLE BONE CHISELS	86
		STILLE BONE GOUGE	61
		STILLE CAST SHEARES	61
		STILLE LISTON BONE CUTTING	67
		FORCEPS STILLE RUSKIN BONE	71
		RONGUER	69
		STITCH SCISSORS	16
		STONE TISSUE FORCEPS	21
		STRABISMUS SCISSORS T.C	100
		SUCTION TUBES	49
		SURGICAL GLOVES STERILE	145
		SYRINGE DISPOSABLE STERILE	145
		<b>T</b>	
		TAYLOR DRESSING / TISSUE FORCEPS	20
		TAYLOR PERCUSSION HAMMER	2, 144
		TEALE TENACULUM FORCEPS	75
		TENACULUM FORCEPS	74
		TENATOMY SCISSORS T.C	100
		THERMOMETERS	145
		THOMAS ALLIS TISSUE FORCEPS	10
		THOMAS GAYLOR UTERINE BIOPSY FORCEPS	80
		THOMAS UTERINE CURETTE	79
		THORACOTOMY RIB SPRADERS MINI	53
		THUDICHUM NASAL SPECULUM	39
		TIECK HALLE NASAL SPECULUM	38
		TISCHLER BABY BIOPSY FORCEPS	82
		TISCHLER BIOPSY FORCEPS	82
		TISCHLER KEVOKIAN BIOPSY FORCEPS	82
		TISSUE FORCEPS	19
		TOENNIS NEEDLE HOLDER	25
		TONGUE DEPRESSOR	35
		TOWEL CLAMP	12
		TOYNEBEE EAR SPECULUM	20
		TRACHEA RETRACTOR	46
		TROUTMAN COLIBRI FORCEPS	87
		TUBE FORCEPS	10
		TUBE OCCULADING FORCEPS	10
		TUFFIER RIB SPRADERS TUFFLIMIRE	53
		TUNNING FORK	126
		TUNNING FORK SET	51
		TUTTLY LASER FORCEPS	143
		TYREEL HOOK	111
			26
		<b>U</b>	
		U.S ARMY RETRACTOR	27
		U.S UMBILICAL SCISSORS	17
		ULRICH COTTON SWAB FORCEPS	11
		UNIVERSAL PLIER	139
		UNIVERSAL WIRE CUTTER T.C	100
		URINAL JUG FEMAIL	114
		URINAL JUG MAIL	114
		UTILITY SCISSORS	144
		<b>V</b>	
		VAN BUREN SOUND	76
		VANNAS SCISSORS	91
		VERBRUGGE BONE HOLDING FORCEPS	65
		VIENNA DOUBLE BLUNT EYE HOOK	146



# INDEX

VIENNA NASAL SPECULUM	39
VIRTUS SPLINTER FORCEPS	22
VOLKMAN BONE CURETTE	60
VOLKMAN RETRACTOR	29
VOLTOLINI NASAL SPECULUM	39

## W

WAGENER EAR FORCEPS	45
WALTER SPLINTER FORCEPS	22
WANGENSTEEN FORCEPS T.C	101
WARTENBERG NEUROLOGICAL PIN	2
WHEEL WAX CARVERS	129
WEBSTER NEEDLE HOLDER	23
WECKER SCISSORS	90
WEIL BLAKESLEY RONGUER	56
WEINGART UTILITY PLIER	139
WEITLANER RETRACTOR	32
WESTCOTT TENOTOMY SCISSORS	91
WHEELER SPATULA	85
WHITE TOENAIL SCISSORS	146
WHITEHEAD MOUTH GAG	36
WIENER SKIN HOOK	26
WILLIAM SPLINTER FORCEPS	22
WILLIAMS TISSUE FORCEPS T.C	103
WILLIGER HAMMER	62
WINDOW POUNCHER	145
WINTER BIOPSY FORCEPS	81
WINTER FORCEPS	83
WIRE BENDING PLIER	139
WIRE CUTTING FORCEPS T.C	107
WIRE CUTTING PLIER	72, 73
WIRE HOLDING FORCEPS T.C	107
WIRE MASH TRAY	114
WIRE TWISTING FORCEPS T.C	107
WULLSEEIN CURETTE	47
WULLSTEIN EAR INSTRUMENTS	46

## Y

YOUNG TONGUE FORCEPS	35, 144
----------------------	---------



# TECHNICON INSTRUMENTS



**PLOT No.191, NEAR FLYOVER KASHMIR  
ROAD ,SIALKOT 51310 ,PAKISTAN.**



**HTTPS://WWW.TECHNICONINST.COM**



**INFO@TECHNICONINST.COM**



**+92-52-4271638  
+92-52-3555594**



**+92+310-3372836**